

Intel[®] Xeon[®] Processor E5 Family

Specification Update

July 2014



INFORMATION IN THIS DOCUMENT IS PROVIDED IN CONNECTION WITH INTEL® PRODUCTS. NO LICENSE, EXPRESS OR IMPLIED, BY ESTOPPEL OR OTHERWISE, TO ANY INTELLECTUAL PROPERTY RIGHTS IS GRANTED BY THIS DOCUMENT. EXCEPT AS PROVIDED IN INTEL'S TERMS AND CONDITIONS OF SALE FOR SUCH PRODUCTS, INTEL ASSUMES NO LIABILITY WHATSOEVER, AND INTEL DISCLAIMS ANY EXPRESS OR IMPLIED WARRANTY, RELATING TO SALE AND/OR USE OF INTEL PRODUCTS INCLUDING LIABILITY OR WARRANTIES RELATING TO FITNESS FOR A PARTICULAR PURPOSE, MERCHANTABILITY, OR INFRINGEMENT OF ANY PATENT, COPYRIGHT OR OTHER INTELLECTUAL PROPERTY RIGHT.

A "Mission Critical Application" is any application in which failure of the Intel Product could result, directly or indirectly, in personal injury or death. SHOULD YOU PURCHASE OR USE INTEL'S PRODUCTS FOR ANY SUCH MISSION CRITICAL APPLICATION, YOU SHALL INDEMNIFY AND HOLD INTEL AND ITS SUBSIDIARIES, SUBCONTRACTORS AND AFFILIATES, AND THE DIRECTORS, OFFICERS, AND EMPLOYEES OF EACH, HARMLESS AGAINST ALL CLAIMS COSTS, DAMAGES, AND EXPENSES AND REASONABLE ATTORNEYS' FEES ARISING OUT OF, DIRECTLY OR INDIRECTLY, ANY CLAIM OF PRODUCT LIABILITY, PERSONAL INJURY, OR DEATH ARISING IN ANY WAY OUT OF SUCH MISSION CRITICAL APPLICATION, WHETHER OR NOT INTEL OR ITS SUBCONTRACTOR WAS NEGLIGENT IN THE DESIGN, MANUFACTURE, OR WARNING OF THE INTEL PRODUCT OR ANY OF ITS PARTS.

Intel products are not intended for use in medical, life saving, life sustaining, critical control or safety systems, or in nuclear facility applications.

Intel may make changes to specifications and product descriptions at any time, without notice.

Designers must not rely on the absence or characteristics of any features or instructions marked "reserved" or "undefined." Intel reserves these for future definition and shall have no responsibility whatsoever for conflicts or incompatibilities arising from future changes to them.

Intel processor numbers are not a measure of performance. Processor numbers differentiate features within each processor family, not across different processor families. See http://www.intel.com/products/processor_number for details.

Hyper-Threading Technology requires a computer system with a processor supporting HT Technology and an HT Technology enabled chipset, BIOS and operating system. Performance will vary depending on the specific hardware and software you use. For more information including details on which processors support HT Technology, see http://www.intel.com/products/ht/hyperthreading_more.htm.

Enabling Execute Disable Bit functionality requires a PC with a processor with Execute Disable Bit capability and a supporting operating system. Check with your PC manufacturer on whether your system delivers Execute Disable Bit functionality.

64-bit computing on Intel architecture requires a computer system with a processor, chipset, BIOS, operating system, device drivers and applications enabled for Intel® 64 architecture. Performance will vary depending on your hardware and software configurations. Consult with your system vendor for more information.

Intel® Virtualization Technology (Intel® VT) requires a computer system with an enabled Intel® processor, BIOS, virtual machine monitor (VMM) and, for some uses, certain computer system software enabled for it. Functionality, performance or other benefits will vary depending on hardware and software configurations and may require a BIOS update. Software applications may not be compatible with all operating systems. Please check with your application vendor.

Intel® Turbo Boost Technology requires a PC with a processor with Intel Turbo Boost Technology capability. Intel Turbo Boost Technology performance varies depending on hardware, software and overall system configuration. Check with your PC manufacturer on whether your system delivers Intel Turbo Boost Technology. For more information, see www.intel.com.

No computer system can provide absolute security under all conditions. Intel® Trusted Execution Technology (Intel® TXT) requires a computer system with Intel® Virtualization Technology, an Intel TXT-enabled processor, chipset, BIOS, Authenticated Code Modules and an Intel TXT-compatible measured launched environment (MLE). Intel TXT also requires the system to contain a TPM v1.s. For more information, visit <http://www.intel.com/technology/security>

Requires an Intel® HD Audio enabled system. Consult your PC manufacturer for more information. Sound quality will depend on equipment and actual implementation. For more information about Intel HD Audio, refer to Intel® High Definition Audio

The Intel® Xeon® Processor E5 Family may contain design defects or errors known as errata which may cause the product to deviate from published specifications. Current characterized errata are available on request.

Contact your local Intel sales office or your distributor to obtain the latest specifications and before placing your product order.

Copies of documents which have an order number and are referenced in this document, or other Intel literature, may be obtained by calling 1-800-548-4725, or go to: <http://www.intel.com/design/literature.htm%20>.

I²C is a two-wire communications bus/protocol developed by Philips. SMBus is a subset of the I²C bus/protocol and was developed by Intel. Implementations of the I²C bus/protocol may require licenses from various entities, including Philips Electronics N.V. and North American Philips Corporation.

Intel, Xeon, Pentium, Intel Core, Enhanced Intel SpeedStep® Technology, and the Intel logo are trademarks of Intel Corporation in the United States and other countries.

*Other names and brands may be claimed as the property of others.

Copyright © 2014, Intel Corporation. All Rights Reserved.

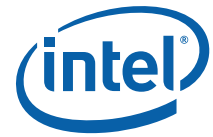

Contents

Revision History	4
Preface	5
Summary Table of Changes	7
BIOS ACM and SINIT ACM Errata Summary	18
Identification Information	20
Errata	25
BIOS ACM Errata	87
SINIT ACM Errata	90
Specification Changes	91
Specification Clarifications	92
Documentation Changes	93
Mixed Processors Within DP Platforms	107



Revision History

Date	Revision	Description
March 2012	-001	<ul style="list-style-type: none"> Initial Release
April 2012	-002	<ul style="list-style-type: none"> Added Errata BT176-BT207 Added S-Spec numbers for the E5-4650, E5-4650L, E5-4640, E5-4620, E5-4617, E5-4610, E5-4607, E5-4603, E5-2449, E5-2648L, E5-2658, E5-1620, E5-2428 Added BIOS ACM Erratum 6-9 Updated BIOS ACM Release Table
May 2012	-003	<ul style="list-style-type: none"> Added Errata BT208-BT228 Added note on mixed processor steppings Added Documentation Changes Corrected DDR speed and Intel QPI speed for E5-2643 Added BIOS ACM 1.3 and BIOS SINIT 1.1 releases
June 2012	-004	<ul style="list-style-type: none"> Added Errata BT229, BT230 Added BIOS ACM 1.4B and 1.4E Added BIOS ACM Erratum 13-15 Added New SKUs
July 2012	-005	<ul style="list-style-type: none"> Updated Erratum BT123 Added Document Change 4
August 2012	-006	<ul style="list-style-type: none"> Added Errata BT231, BT232, BT233 and BT234 Updated Document Change 3 Added Document Change 5
September 2012	-007	<ul style="list-style-type: none"> Added Errata BT235 and BT236 Added Note 7 to Table 6.
October 2012	-008	<ul style="list-style-type: none"> Removed Erratum BT154 Added Document Change 6 and 7
November 2012	-009	<ul style="list-style-type: none"> Added Erratum BT237
December 2012	-010	<ul style="list-style-type: none"> Added errata BT238, BT239 and BT240
January 2013	-011	<ul style="list-style-type: none"> Added Document Change 8
March 2013	-012	<ul style="list-style-type: none"> Added Errata BT241 and BT242 Corrected E5-2643 core counts
April 2013	-013	<ul style="list-style-type: none"> Added Errata BT243 Added Document Changes 9 and 10 Corrected frequency for E5-2609 processors
August 2013	-014	<ul style="list-style-type: none"> Added Errata BT244-BT248 Updated erratum BT243 Updated BIOS and SINIT ACM release table Added Doc Changes 11-15
January 2014	-015	<ul style="list-style-type: none"> Added erratum BT249
July 2014	-016	<ul style="list-style-type: none"> Updated BT243 Added errata BT250 and BT251 Update document link Added Doc Change 20



Preface

This document is an update to the specifications contained in the [Affected Documents](#) table below. This document is a compilation of device and documentation sighting, specification clarifications and changes. It is intended for hardware system manufacturers and software developers of applications, operating systems, or tools.

Information types defined in [Nomenclature](#) are consolidated into the specification update and are no longer published in other documents.

This document may also contain information that was not previously published.

Affected Documents

Document Title	Document Number ¹ / Location
Intel® Xeon® E5-2400 Product Family Datasheet- Volume One	327248-001 ²
Intel® Xeon® Processor E5-1600/E5-2600/E5-4600 Product Families Datasheet - Volume One	326508-002 ²
Intel® Xeon® Processor E5-1600/E5-2400/E5-2600/E5-4600 Product Families Datasheet - Volume Two	326509-003 ²

Notes:

1. Contact your Intel representative for the latest revision and order number of this document.
2. Available on www.intel.com

Related Documents

Document Title	Document Number/ Location
AP-485, Intel® Processor Identification and the CPUID Instruction	241618
Voltage Regulator Module (VRM) and Enterprise Voltage Regulator-Down (EVRD) 12.0 Design Guidelines, Rev. 1.0	427213
Intel® 64 and IA-32 Architecture Software Developer's Manual <ul style="list-style-type: none">• Volume 1: Basic Architecture• Volume 2A: Instruction Set Reference Manual A-M• Volume 2B: Instruction Set Reference Manual N-Z• Volume 3A: System Programming Guide• Volume 3B: System Programming Guide• IA-32 Intel® Architecture Optimization Reference Manual	325462
Intel® Advanced Vector Extensions Programming Reference	319433
Intel® Virtualization Technology for Directed I/O Architecture	D51397
Intel® Trusted Execution Technology (Intel® TXT) Server BIOS Specification	315168

Notes:

1. Contact your Intel representative for the latest revision and order number of this document.

Nomenclature

S-Spec Number is a five-digit code used to identify products. Products are differentiated by their unique characteristics, for example, core speed, L2 cache size, package type, etc. as described in the processor identification information table. Read all notes associated with each S-Spec number.



Specification Changes are modifications to the current published specifications. These changes will be incorporated in any new release of the specification.

Specification Clarifications describe a specification in greater detail or further highlight a specification's impact to a complex design situation. These clarifications will be incorporated in any new release of the specification.

Documentation Changes include typos, errors, or omissions from the current published specifications. These will be incorporated in any new release of the specification.

Note: Specification changes, specification clarifications and documentation changes are removed from the specification update when the appropriate changes are made to the appropriate product specification or user documentation (datasheets, manuals, and so forth).

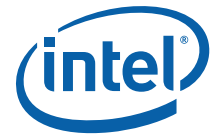

Summary Table of Changes

The table included in this section indicate the errata, Specification Changes, Specification Clarifications, or Document Changes which apply to the Intel® Xeon® Processor E5 Family. Intel may fix some of the errata in a future stepping of the component, and account for the other outstanding issues through documentation or specification changes as noted.

Codes Used in Summary Tables

Stepping

X: Errata exists in the stepping indicated. Specification Change or Clarification that applies to this stepping.

(No mark) or (Blank box):

This erratum is fixed in listed stepping or specification change does not apply to listed stepping.

Status

Doc: Document change or update will be implemented.

Plan Fix: This erratum may be fixed in a future stepping of the product.

Fixed: This erratum has been previously fixed.

No Fix: There are no plans to fix this erratum.

Row

Change bar to left of table row indicates this erratum is either new or modified from the previous version of the document.



Table 1. Errata Summary Table (Sheet 1 of 11)

Errata Number	Stepping			Status	ERRATA
	C-1	C-2	M-1		
BT1.	X	X	X	No Fix	An Enabled Debug Breakpoint or Single Step Trap May Be Taken after MOV SS/POP SS Instruction if it is Followed by an Instruction That Signals a Floating Point Exception
BT2.	X	X	X	No Fix	APIC Error "Received Illegal Vector" May be Lost
BT3.	X	X	X	No Fix	An Uncorrectable Error Logged in IA32_CR_MC2_STATUS May also Result in a System Hang
BT4.	X	X	X	No Fix	B0-B3 Bits in DR6 For Non-Enabled Breakpoints May be Incorrectly Set
BT5.	X	X	X	No Fix	Changing the Memory Type for an In-Use Page Translation May Lead to Memory-Ordering Violations
BT6.	X	X	X	No Fix	Code Segment Limit/Canonical Faults on RSM May be Serviced before Higher Priority Interrupts/Exceptions and May Push the Wrong Address Onto the Stack
BT7.	X	X	X	No Fix	Corruption of CS Segment Register During RSM While Transitioning From Real Mode to Protected Mode
BT8.	X	X	X	No Fix	Debug Exception Flags DR6.B0-B3 Flags May be Incorrect for Disabled Breakpoints
BT9.	X	X	X	No Fix	DR6 May Contain Incorrect Information When the First Instruction After a MOV SS,r/m or POP SS is a Store
BT10.	X	X	X	No Fix	EFLAGS Discrepancy on Page Faults and on EPT-Induced VM Exits after a Translation Change
BT11.	X	X	X	No Fix	Fault on ENTER Instruction May Result in Unexpected Values on Stack Frame
BT12.	X	X	X	No Fix	Faulting MMX Instruction May Incorrectly Update x87 FPU Tag Word
BT13.	X	X	X	No Fix	FREEZE_WHILE_SMM Does Not Prevent Event From Pending PEBS During SMM
BT14.	X	X	X	No Fix	General Protection Fault (#GP) for Instructions Greater than 15 Bytes May be Preempted
BT15.	X	X	X	No Fix	#GP on Segment Selector Descriptor that Straddles Canonical Boundary May Not Provide Correct Exception Error Code
BT16.	X	X	X	No Fix	IO_SMI Indication in SMRAM State Save Area May be Set Incorrectly
BT17.	X	X	X	No Fix	IRET under Certain Conditions May Cause an Unexpected Alignment Check Exception
BT18.	X	X	X	No Fix	LER MSRs May Be Unreliable
BT19.	X	X	X	No Fix	LBR, BTS, BTM May Report a Wrong Address when an Exception/Interrupt Occurs in 64-bit Mode
BT20.	X	X	X	No Fix	MCi_Status Overflow Bit May Be Incorrectly Set on a Single Instance of a DTLB Error
BT21.	X	X	X	No Fix	MONITOR or CLFLUSH on the Local XAPIC's Address Space Results in Hang
BT22.	X	X	X	No Fix	MOV To/From Debug Registers Causes Debug Exception
BT23.	X	X	X	No Fix	PEBS Record not Updated when in Probe Mode
BT24.	X	X	X	No Fix	Performance Monitor Counter INST_RETIRED.STORES May Count Higher than Expected
BT25.	X	X	X	No Fix	Performance Monitoring Event FP_MMX_TRANS_TO_MMX May Not Count Some Transitions
BT26.	X	X	X	No Fix	REP MOVSB/STOSB Executing with Fast Strings Enabled and Crossing Page Boundaries with Inconsistent Memory Types may use an Incorrect Data Size or Lead to Memory-Ordering Violations.
BT27.	X	X	X	No Fix	Reported Memory Type May Not Be Used to Access the VMCS and Referenced Data Structures



Table 1. Errata Summary Table (Sheet 1 of 11)

Errata Number	Stepping			Status	ERRATA
	C-1	C-2	M-1		
BT28.	X	X	X	No Fix	Single Step Interrupts with Floating Point Exception Pending May Be Mishandled
BT29.	X	X	X	No Fix	Storage of PEBS Record Delayed Following Execution of MOV SS or STI
BT30.	X	X	X	No Fix	The Processor May Report a #TS Instead of a #GP Fault
BT31.	X	X	X	No Fix	VM Exits Due to "NMI-Window Exiting" May Be Delayed by One Instruction
BT32.	X	X	X	No Fix	Values for LBR/BTS/BTM Will be Incorrect after an Exit from SMM
BT33.	X	X	X	No Fix	VPHMINPOSUW Instruction in VEX Format Does Not Signal #UD (Invalid Opcode Exception) When vex.vvvv != 1111
BT34.	X	X	X	No Fix	Pending x87 FPU Exceptions (#MF) May be Signaled Earlier Than Expected
BT35.	X	X	X	No Fix	VMREAD/VMWRITE Instruction May Not Fail When Accessing an Unsupported Field in VMCS
BT36.	X	X	X	No Fix	Unexpected #UD on VZEROALL/VZERoupper
BT37.	X	X	X	No Fix	Execution of Opcode 9BH with the VEX Opcode Extension May Produce a #NM Exception
BT38.					Erratum Removed
BT39.	X	X	X	No Fix	An Unexpected Page Fault or EPT Violation May Occur After Another Logical Processor Creates a Valid Translation for a Page
BT40.	X	X	X	No Fix	Execution of FXSAVE or FXRSTOR With the VEX Prefix May Produce a #NM Exception
BT41.	X	X	X	No Fix	Unexpected #UD on VPEXTRD/VPINSRD
BT42.	X	X	X	No Fix	#GP May be Signaled When Invalid VEX Prefix Precedes Conditional Branch Instructions
BT43.	X	X	X	No Fix	LBR, BTM or BTS Records May have Incorrect Branch From Information After an Enhanced Intel® SpeedStep Technology/T-state/S-state/C1E Transition or Adaptive Thermal Throttling
BT44.	X	X	X	No Fix	A Write to the IA32_FIXED_CTR1 MSR May Result in Incorrect Value in Certain Conditions
BT45.	X	X	X	No Fix	Instruction Fetch May Cause Machine Check if Page Size and Memory Type Was Changed Without Invalidation
BT46.	X	X	X	No Fix	L1 Data Cache Errors May be Logged With Level Set to 1 Instead of 0
BT47.	X	X	X	No Fix	Warm Reset May Leave the System in an Invalid Poisoning State and Could Cause The Feature to be Disabled
BT48.	X	X	X	No Fix	VM Entries That Return From SMM Using VMLAUNCH May Not Update The Launch State of the VMCS
BT49.	X	X	X	No Fix	Interrupt From Local APIC Timer May Not Be Detectable While Being Delivered
BT50.					Erratum Removed
BT51.	X	X	X	No Fix	Poison Packets Will be Reported to PCIe Port 1a When Forwarded to Port 1b
BT52.	X	X	X	No Fix	IA32_MCI_ADDR Overwritten in The Case of Multiple Recoverable Instruction Fetch Errors
BT53.	X	X	X	No Fix	The Processor Does not Detect Intel® QuickPath Interconnect (Intel® QPI) RSVD_CHK Field Violations
BT54.	X	X	X	No Fix	The Intel QPI Link Status Register LinkInitStatus Field Incorrectly Reports "Internal Stall Link Initialization" For Certain Stall Conditions
BT55.	X	X	X	No Fix	Intel QPI Tx AC Common Mode Fails Specification
BT56.	X	X	X	No Fix	PROCHOT_N Assertion During Warm Reset May Disable a Processor Via The FRB Mechanism



Table 1. Errata Summary Table (Sheet 1 of 11)

Errata Number	Stepping			Status	ERRATA
	C-1	C-2	M-1		
BT57.	X	X	X	No Fix	The PCIe* Current Compensation Value Default is Incorrect
BT58.	X	X	X	No Fix	The PCIe* Link at 8.0 GT/s is Transitioning too Soon to Normal Operation While Training
BT59.	X	X	X	No Fix	QPILS Reports the VNA/VN0 Credits Available for the Processor Rx Rather Than Tx
BT60.	X	X	X	No Fix	The Router Value Exchanged During Intel QPI Link Layer Initialization is Set to Zero
BT61.	X	X	X	No Fix	A First Level Data Cache Parity Error May Result in Unexpected Behavior
BT62.	X	X	X	No Fix	The Processor Incorrectly Indicates That 16-bit Rolling CRC is Supported
BT63.	X	X	X	No Fix	PECI Write Requests That Require a Retry Will Always Time Out
BT64.	X	X	X	No Fix	The Vswing of the PCIe* Transmitter Exceeds The Specification
BT65.	X	X	X	No Fix	Intel QPI Interface Calibration May Log Spurious Bus and Interconnect Error Machine Checks
BT66.	X	X	X	No Fix	When a Link is Degraded on a Port due to PCIe* Signaling Issues Correctable Receiver Errors May be Reported on The Neighboring Port
BT67.	X	X	X	No Fix	A CMCI is Only Generated When the Memory Controller's Correctable Error Count Threshold is Exceeded
BT68.	X	X	X	No Fix	PCIe* Rx DC Common Mode Impedance is Not Meeting the Specification
BT69.	X	X	X	No Fix	A Modification to the Multiple Message Enable Field Does Not Affect the AER Interrupt Message Number Field
BT70.	X	X	X	No Fix	Unexpected PCIe* Set_Slot_Power_Limit Message on Writes to LNKCON
BT71.	X	X	X	No Fix	Enabling Intel QPI L0s State May Prevent Entry into L1
BT72.					Erratum Removed
BT73.	X	X	X	No Fix	Locked Accesses Spanning Cachelines That Include PCI Space May Lead to a System Hang
BT74.	X	X	X	No Fix	Intel QPI Training Sensitivities Related to Clock Detection
BT75.	X	X	X	No Fix	Cold Boot May Fail Due to Internal Timer Error
BT76.	X	X	X	No Fix	PCIe* Rx Common Mode Return Loss is Not Meeting The Specification
BT77.	X	X	X	No Fix	The Most Significant Bit of the CEC Cannot be Cleared Once Set
BT78.	X	X	X	No Fix	An Unexpected Page Fault or EPT Violation May Occur After Another Logical Processor Creates a Valid Translation for a Page
BT79.	X	X	X	No Fix	PCIe* Adaptive Equalization May Not Train to the Optimal Settings.
BT80.	X	X	X	No Fix	A Core May Not Complete Transactions to The Caching Agent When C-States Are Enabled Leading to an Internal Timer Error
BT81.	X	X	X	No Fix	TSC is Not Affected by Warm Reset
BT82.	X	X	X	No Fix	Warm Resets May be Converted to Power-on Resets When Recovering From an IERR
BT83.	X	X	X	No Fix	Using DMA XOR With DCA May Cause a Machine Check
BT84.	X	X	X	No Fix	Mixed DMA XOR and Legacy Operations in The Same Channel May Cause Data to be Observed Out of Order
BT85.	X	X	X	No Fix	Unexpected DMA XOR Halt and Errors when Using Descriptors With P or Q Operations Disabled
BT86.	X	X	X	No Fix	DMA XOR Channel May Hang on Source Read Completion Data Parity Error For >8K Descriptors

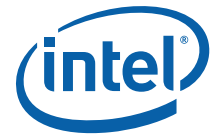

Table 1. Errata Summary Table (Sheet 1 of 11)

Errata Number	Stepping			Status	ERRATA
	C-1	C-2	M-1		
BT87.	X	X	X	No Fix	DMA CB_BAR Decode May be Incorrect After DMA FLR
BT88.	X	X	X	No Fix	XOR DMA Restricted to £ 8 KB Transfers When Multiple Channels Are in use
BT89.	X	X	X	No Fix	Unable to Restart DMA After Poisoned Error During an XOR Operation
BT90.	X	X	X	No Fix	DMA Restart Hang When First Descriptor is a Legacy Type Following Channel HALT Due to an Extended Descriptor Error
BT91.	X	X	X	No Fix	JSP CBDMA errata BF508S: Operation With DMA XOR Interrupts/ Completions Enabled Restricted to Channel 0 and 1
BT92.	X	X	X	No Fix	Suspending/Resetting an Active DMA XOR Channel May Cause an Incorrect Data Transfer on Other Active Channels
BT93.	X	X	X	No Fix	DWORD-Aligned DMA XOR Descriptors With Fencing and Multi-Channel Operation May Cause a Channel Hang
BT94.					Erratum Removed
BT95.	X	X	X	No Fix	Processor May not Restore the VR12 DDR3 Voltage Regulator Phases upon Pkg C3 State Exit
BT96.	X	X	X	No Fix	Intel QPI Link Layer Does Not Drop Unsupported or Undefined Packets
BT97.	X	X	X	No Fix	The Equalization Phase Successful Bits Are Not Compliant to the PCIe* Specification
BT98.	X			Fixed	The Intel® Virtualization Technology for Directed I/O (Intel® VT-d) Queued Invalidation Status Write May Fail
BT99.	X	X	X	No Fix	FP Data Operand Pointer May Be Incorrectly Calculated After an FP Access Which Wraps a 64-Kbyte Boundary in 16-Bit Code
BT100.	X	X	X	No Fix	Executing The GETSEC Instruction While Throttling May Result in a Processor Hang
BT101.	X	X	X	No Fix	Incorrect Address Computed for Last Byte of FXSAVE/FXRSTOR or XSAVE/XRSTOR Image Leads to Partial Memory Update
BT102.	X	X	X	No Fix	FP Data Operand Pointer May be Incorrectly Calculated After an FP Access Which Wraps a 4-Gbyte Boundary in Code That Uses 32-bit Address Size in 64-bit Mode
BT103.	X	X	X	No Fix	Execution of VAESIMC or VAESKEYGENASSIST With An Illegal Value for VEX.vvvv May Produce a #NM Exception
BT104.	X	X	X	No Fix	Removed Duplicate Erratum
BT105.	X	X	X	No Fix	LBR May Contain Incorrect Information When Using FREEZE_LBRS_ON_PMI
BT106.	X	X	X	No Fix	Performance Monitoring May Overcount Some Events During Debugging
BT107.	X	X	X	No Fix	HDRLOG Registers do not Report the Header for PCIe* Port 1 Packets with Detected Errors
BT108.	X	X	X	No Fix	PECI Temperature Data Values Returned During Reset May be Non-Zero
BT109.	X	X	X	No Fix	TSOD Related SMBus Transactions May not Complete When Package C-States are Enabled
BT110.	X	X	X	No Fix	Erratum Removed
BT111.	X	X	X	No Fix	DRAM RAPL Dynamic Range is too Narrow on the Low Side
BT112.	X	X	X	No Fix	MCACOD 0119H Reported in IA32_MC3_Status is Ambiguous
BT113.	X	X	X	No Fix	The Processor Incorrectly Transitions from Polling.Active to Polling.Compliance After Receiving Two TS1 Ordered Sets with the Compliance Bit Set
BT114.	X	X	X	No Fix	Patrol Scrubbing May Not Resume Properly After Package C3 and Package C6 States



Table 1. Errata Summary Table (Sheet 1 of 11)

Errata Number	Stepping			Status	ERRATA
	C-1	C-2	M-1		
BT115.	X	X	X	No Fix	Shallow Self-Refresh Mode is Used During S3
BT116.	X	X	X	No Fix	Platform Idle Power May be Higher Than Expected
BT117.	X	X	X	No Fix	PECI Transactions during an S-State Transition May Result in a Platform Cold Reset
BT118.	X	X	X	No Fix	Complex Platform Conditions during a Transition to S4 or S5 State May Result in an Internal Timeout Error
BT119.	X	X	X	No Fix	Writes to SDOORBELL or B2BDOORBELL in Conjunction With Inbound Access to NTB MMIO Space May Hang System
BT120.	X	X	X	No Fix	Programming PDIR And an Additional Precise PerfMon Event May Cause Unexpected PMI or PEBS Events
BT121.	X	X	X	No Fix	A Peci RdIAMS Command Near IERR Assertion May Cause the Peci Interface to Become Unresponsive
BT122.	X	X	X	No Fix	Long Latency Transactions May Cause I/O Devices on the Same Link to Time Out
BT123.	X	X	X	No Fix	The Coherent Interface Error Codes "C2", "C3", "DA" and "DB" are Incorrectly Flagged
BT124.	X	X	X	No Fix	If Multiple Poison Events Are Detected within Two Core Clocks, the Overflow Flag May not be Set
BT125.	X	X	X	No Fix	PCI Express* Capability Structure Not Fully Implemented
BT126.	X	X	X	No Fix	The PCIe* Receiver Lanes Surge Protection Circuit May Intermittently Cause a False Receive Detection on Some PCIe Devices
BT127.	X	X	X	No Fix	Software Reads From LMMIOH_LIMIT Register May be Incorrect
BT128.	X	X	X	No Fix	Patrol Scrub is Incompatible with Rank Sparing on More than One Channel
BT129.	X	X	X	No Fix	Multi-Socket Intel® TXT Platform May Enter a Sequence of Warm Resets
BT130.	X	X	X	No Fix	NTB May Incorrectly Set MSI or MSI-X Interrupt Pending Bits
BT131.	X	X	X	No Fix	DWORD Aligned XOR DMA Sources May Prevent Further DMA XOR Progress
BT132.	X	X	X	No Fix	Using I/O Peer-to-Peer Write Traffic Across an NTB May Lead to a Hang
BT133.	X	X	X	No Fix	Unable to Clear Received PME_TO_ACK in NTB
BT134.	X	X	X	No Fix	NTB Does Not Set PME_TO_ACK After a PME_TURN_OFF Request
BT135.	X	X	X	No Fix	PCMPESTR1, PCMPESTRM, VPCMPESTR1 and VPCMPESTRM Always Operate with 32-bit Length RegistersPCMPESTR1, PCMPESTRM, VPCMPESTR1 and VPCMPESTRM Always Operate with 32-bit Length Registers
BT136.	X	X	X	No Fix	PECI Commands Differing Only in Length Field May be Interpreted as Command Retries
BT137.	X	X	X	No Fix	Performance Monitor Precise Instruction Retired Event May Present Wrong Indications
BT138.	X	X	X	No Fix	VM Exits from Real-Address Mode Due to Machine Check Exceptions May Incorrectly Save RFLAGS.RF as 1
BT139.	X	X	X	No Fix	The Integrated Memory Controller Does Not Enforce CKE High for tXSDLL DCLKs After Self-Refresh
BT140.	X	X	X	No Fix	The Default Value of the I/O Base Address Field Does Not Comply with the PCI-to-PCI Bridge Architecture Specification
BT141.	X	X	X	No Fix	A Sustained Series of PCIe* Posted Upstream Writes Can Lead to Deadlock
BT142.	X	X	X	No Fix	Extraneous Characters are Included in the Processor Brand String

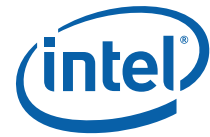

Table 1. Errata Summary Table (Sheet 1 of 11)

Errata Number	Stepping			Status	ERRATA
	C-1	C-2	M-1		
BT143.	X	X	X	No Fix	IMC Controlled Dynamic DRAM Refresh Rate Can Lead to Unpredictable System Behavior
BT144.	X	X	X	No Fix	Incorrect Error Address Status May Get Logged
BT145.	X	X	X	No Fix	The Machine Check Threshold-Based Error Status Indication May be Incorrect
BT146.	X	X	X	No Fix	IA32_MCI_STATUS Registers May Contain Undefined Data After Reset
BT147.	X	X	X	No Fix	Refresh Cycles for High Capacity DIMMs Are Not Staggered
BT148.	X	X	X	No Fix	A Stream of Snoops Can Lead to a System Hang or Machine Check
BT149.	X	X	X	No Fix	IA32_MCI_STATUS.EN May Not be Set During Certain Machine Check Exceptions
BT150.	X	X	X	No Fix	Intel QPI Link Physical Layer error results in MCERR during warm reset
BT151.	X	X	X	No Fix	LLC Cache Correctable Errors Are Not Counted And Logged
BT152.	X	X	X	No Fix	The Processor Incorrectly Transitions From The PCIe* Recovery.RcvrLock LTSSM State to the Configuration.Linkwidth.Start LTSSM State
BT153.	X	X	X	No Fix	Writes to B2BSPAD[15:0] Registers May Transfer Corrupt Data Between NTB Connected Systems
BT154.					Erratum Removed
BT155.	X	X	X	No Fix	Excessive DRAM RAPL Power Throttling May Lead to a System Hang or USB Device Off-Lining
BT156.	X	X	X	No Fix	NTB Operating In NTB/RP Mode With MSI/MSI-X Interrupts May Cause System Hang
BT157.	X	X	X	No Fix	XSAVEOPT May Fail to Save Some State after Transitions Into or Out of STM
BT158.	X	X	X	No Fix	Rank Sparing May Cause an Extended System Stall
BT159.	X	X	X	No Fix	System Hang May Occur when Memory Sparing is Enabled
BT160.	X	X	X	No Fix	Enabling Opportunistic Self-Refresh and Pkg C2 State Can Severely Degrade PCIe* Bandwidth
BT161.	X	X	X	No Fix	Mirrored Memory Writes May Lead to System Failures
BT162.	X	X	X	No Fix	End Agent PCIe Packet Errors May Result in a System Hang
BT163.	X	X	X	No Fix	Retraining Cannot be Initiated by Downstream Devices in NTB/NTB or NTB/RP Configurations
BT164.	X	X	X	No Fix	PCIe Port in NTB Mode Flags Upstream Slot Power Limit Message as UR
BT165.	X	X	X	No Fix	Spurious SMIs May Occur Due to MEMHOT# Assertion
BT166.	X	X	X	No Fix	PCIe Link Bandwidth Notification Capability is Incorrect
BT167.	X	X	X	No Fix	Port 3a Capability_Pointer Field is Incorrect When Configured in PCIe Mode
BT168.	X	X	X	No Fix	Uncorrectable Intel QPI Errors May Cause the System to Power Down
BT169.	X	X	X	No Fix	Four Outstanding PCIe Configuration Retries May Cause Deadlock
BT170.	X	X	X	No Fix	A PECl RdPciConfigLocal Command Referencing a Non-Existent Device May Return an Unexpected Value
BT171.	X	X	X	No Fix	Some PCIe CCR Values Are Incorrect
BT172.	X	X	X	No Fix	When in DMI Mode, Port 0's Device_Port_Type Field is Incorrect
BT173.	X	X	X	No Fix	PCIe TPH Attributes May Result in Unpredictable System Behavior
BT174.	X	X	X	No Fix	Continuous Intel QPI Retraining Feature Indication is Incorrect



Table 1. Errata Summary Table (Sheet 1 of 11)

Errata Number	Stepping			Status	ERRATA
	C-1	C-2	M-1		
BT175.	X	X	X	No Fix	Correctable Memory Errors May Result in Unpredictable System Behavior
BT176.					Not an Erratum
BT177.					Not an Erratum
BT178.	X	X	X	No Fix	IA32_MCI_STATUS ADDR_V Bit May be Incorrectly Cleared
BT179.	X	X	X	No Fix	Intel® QuickData Technology DMA Lock Quiescent Flow Causes DMA State Machine to Hang
BT180.	X	X	X	No Fix	Malformed TLP Power Management Messages May Be Dropped
BT181.	X	X	X	No Fix	Core Frequencies at or Below the DRAM DDR Frequency May Result in Unpredictable System Behavior
BT182.	X	X	X	No Fix	Quad Rank DIMMs May Not be Properly Refreshed During IBT_OFF Mode
BT183.	X	X	X	No Fix	Intel® QuickData Technology DMA Non-Page-Aligned Next Source/Destination Addresses May Result in Unpredictable System Behavior
BT184.	X	X	X	No Fix	Enabling Relaxed Ordering With Intel QuickData Technology May Result in a System Hang
BT185.	X	X	X	No Fix	Spurious CRC Errors May be Detected on Intel QPI Links
BT186.	X	X	X	No Fix	PECI Temperature Lower Limit May be as High as 7°C
BT187.	X	X	X	No Fix	The DRAM Power Meter May Not be Accurate
BT188.	X	X	X	No Fix	PCIe* Port 3 Link Training May be Unreliable in NTB Mode
BT189.	X	X	X	No Fix	Functionally Benign PCIe* Electrical Specification Violation Compendium
BT190.	X	X	X	No Fix	A Machine Check Exception Due to Instruction Fetch May Be Delivered Before an Instruction Breakpoint
BT191.	X	X	X	No Fix	Intel® QPI May Report a Reserved Value in the Link Initialization Status Field During Link Training
BT192.	X	X	X	No Fix	Enhanced Intel SpeedStep® Technology May Cause a System Hang
BT193.	X	X	X	No Fix	PROCHOT May Be Incorrectly Asserted at Reset
BT194.	X	X	X	No Fix	Package C3-State and Package C6-State Residency is Too Low
BT195.	X	X	X	No Fix	PECI RdPkgConfig() May Return Invalid Data For an Unsupported Channel
BT196.	X	X	X	No Fix	DRAM PBM Overflow May Result in a System Hang
BT197.	X	X	X	No Fix	Combining ROL Transactions with Non-ROL Transactions or Marker Skipping Operations May Result In a System Hang
BT198.	X	X	X	No Fix	Error Indication in PCIe Lane Error Status Incorrectly Set When Operating at 8 GT/s
BT199.	X	X	X	No Fix	PCIe* Link May Not Train to Full Width
BT200.	X	X	X	No Fix	The Minimum Snoop Latency Requirement That Can be Specified is 64 Microseconds
BT201.	X	X	X	No Fix	Patrol Scrubbing Doesn't Skip Ranks Disabled After DDR Training
BT202.	X	X	X	No Fix	Simultaneously Enabling Patrol Scrubbing, Package C-States, and Rank Sparing May Cause the Patrol Scrubber to Hang
BT203.	X	X	X	No Fix	Patrol Scrubbing Will Report Uncorrectable Memory Errors Found on a Spare Rank
BT204.	X	X	X	No Fix	Patrol Scrubbing During Memory Mirroring May Improperly Signal Uncorrectable Machine Checks
BT205.	X	X	X	No Fix	Directory Mode and Memory Mirroring are Incompatible with Demand Scrubbing or Mirror Scrubbing



Table 1. Errata Summary Table (Sheet 1 of 11)

Errata Number	Stepping			Status	ERRATA
	C-1	C-2	M-1		
BT206.	X	X	X	No Fix	Spurious Power Limit Interrupt May Occur at Package C-State Exit
BT207.	X	X	X	No Fix	Intel VT-d Translation Fault May Be Dropped
BT208.	X	X	X	No Fix	The Accumulated Energy Status Read Service May Report a Power Spike Early in Boot
BT209.	X	X	X	No Fix	Certain Uncorrectable Errors May Cause Loss of PECCI Functionality
BT210.	X	X	X	No Fix	Machine Check During VM Exit May Result in VMX Abort
BT211.	X	X	X	No Fix	Address of Poisoned Data Logged in IA32_MCI_ADDR MSR May be Incorrect
BT212.	X	X	X	No Fix	Routing Intel® High Definition Audio Traffic Through VC1 May Result in System Hang
BT213.	X	X	X	No Fix	Intel® QuickData Technology DMA Suspend Does Not Transition From ARMED to HALT State
BT214.	X	X	X	No Fix	Package_Energy_Counter Register May Incorrectly Report Power Consumed by The Execution of Intel® Advanced Vector Extensions (Intel® AVX) Instructions
BT215.	X	X	X	No Fix	Suspending/Resetting a DMA XOR Channel May Cause an Incorrect Data Transfer on Other Active Channels
BT216.	X	X	X	No Fix	Intel QPI Power Management May Lead to Unpredictable System Behavior
BT217.	X	X	X	No Fix	Intel® QPI L0s Exit May Cause an Uncorrectable Machine Check
BT218.	X	X	X	No Fix	Coherent Interface Write Cache May Report False Correctable ECC Errors During Cold Reset
BT219.	X	X	X	No Fix	Intel QuickData Technology Continues to Issue Requests After Detecting 64-bit Addressing Errors
BT220.	X	X	X	No Fix	Encountering Poison Data while Memory Mirroring is Enabled May Cause an Invalid Machine Check
BT221.	X	X	X	No Fix	PCIe* RO May Result in a System Hang or Unpredictable System Behavior
BT222.	X	X	X	No Fix	Intel VT-d Invalidation Time-Out Error May Not be Signaled
BT223.	X	X	X	No Fix	Spurious Machine Check Errors May Occur
BT224.	X	X	X	No Fix	Enhanced Intel SpeedStep® Technology Hardware Coordination Cannot be Disabled
BT225.	X	X	X	No Fix	PCIe Link Upconfigure Capability is Incorrectly Advertised as Supported
BT226.	X	X	X	No Fix	The IA32_MCI_MISC.HaDbBank Field Should be Ignored
BT227.	X	X	X	No Fix	When a PCIe x4 Port Detects a Logical Lane 0 Failure, the Link Will Advertise Incorrect Lane Numbers
BT228.	X	X	X	No Fix	Certain PCIe* TLPs May be Dropped
BT229.	X	X	X	No Fix	A Machine Check Exception Concurrent With an I/O SMI May Be Erroneously Reported as Re-startable
BT230.	X	X	X	No Fix	VEX.L is Not Ignored with VCVT*2SI Instructions
BT231.	X	X	X	No Fix	The System Agent Temperature is Not Available
BT232.	X	X	X	No Fix	An ACM Error May Cause a System Power Down
BT233.	X	X	X	No Fix	Incorrect Retry Packets May Be Sent by a PCIe x16 Port Operating at 8 GT/s
BT234.	X	X	X	No Fix	Intel® QuickData Technology May Incorrectly Signal a Master Abort
BT235.	X	X	X	No Fix	MCI_ADDR May be Incorrect For Cache Parity Errors
BT236.	X	X	X	No Fix	Instruction Fetch Page-Table Walks May be Made Speculatively to Uncacheable Memory



Table 1. Errata Summary Table (Sheet 1 of 11)

Errata Number	Stepping			Status	ERRATA
	C-1	C-2	M-1		
BT237.	X	X	X	No Fix	Intel® QuickData Technology DMA Channel Write Abort Errors May Cause a Channel Hang
BT238.	X	X	X	No Fix	The Processor May Not Properly Execute Code Modified Using A Floating-Point Store
BT239.	X	X	X	No Fix	Execution of GETSEC[SEXIT] May Cause a Debug Exception to be Lost
BT240.	X	X	X	No Fix	Warm Reset May Cause PCIe Hot-Plug to Fail
BT241.	X	X	X	No Fix	Certain Local Memory Read / Load Retired PerfMon Events May Undercount
BT242.	X	X	X	No Fix	IA32_MC5_CTL2 is Not Cleared by a Warm Reset
BT243.	X	X	X	No Fix	Performance Monitor Counters May Produce Incorrect Results
BT244.	X	X	X	No Fix	The Corrected Error Count Overflow Bit in IA32_MC0_STATUS is Not Updated After a UC Error is Logged
BT245.	X	X	X	No Fix	IA32_VMX_VMCS_ENUM MSR (48AH) Does Not Properly Report The Highest Index Value Used For VMCS Encoding
BT246.	X	X	X	No Fix	The Upper 32 Bits of CR3 May be Incorrectly Used With 32-Bit Paging
BT247.	X	X	X	No Fix	EPT Violations May Report Bits 11:0 of Guest Linear Address Incorrectly
BT248.	X	X	X	No Fix	Virtual-APIC Page Accesses With 32-Bit PAE Paging May Cause a System Crash
BT249.	X	X	X	No Fix	PCIe* Header of a Malformed TLP is Logged Incorrectly
BT250.	X	X	X	No Fix	VM Exit May Set IA32_EFER.NXE When IA32_MISC_ENABLE Bit 34 is Set to 1
BT251.	X	X	X	No Fix	Platform Recovery After a Machine Check May Fail

Specification Changes

Number	SPECIFICATION CHANGES
1	There are no Specification Changes at this time.

Specification Clarifications

Number	SPECIFICATION CHANGES
1	EDS Volume 2

Documentation Changes

Number	SPECIFICATION CHANGES
1	Datasheet Volume 2: Table 4.7.2.3 (IntControl: Interrupt Control Register):
2	Datasheet Volume 2: VTDO_EXT_CAP register:
3	Datasheet Volume 2: I/O APIC Capability List Implementation
4	Datasheet Volume 1: Statement of Volatility
5	Datasheet Volume 2: IRP_MISC_DFX0: Coherent Interface Miscellaneous DFX 0
6	Datasheet Volume 1: E5-1600 Product Family Definitions
7	Datasheet Volume 1: E5-1600 Product Family Thermal Definitions
8	SDM, Volume 3B: On-Demand Clock Modulation Feature Clarification



Documentation Changes

Number	SPECIFICATION CHANGES
9	When transient errors are injected during memory read using MEI tool, CORRERRCNT_N and IA32_MC5_STATUS[58:32] do not log same number of corrected errors
10	Datasheet Volume 1 Table 2-11, footnote 5 is incorrect for E5-2400 processors.
11	Datasheet Volume 2: Figure 1-1 Processor Integrated I/O Device Map.
12	Local Peer to Peer PCIe transactions:
13	Datasheet Volume 2: Sections 3.5.3.16 and 17:
14	Datasheet Volume 2: Chapter 7: Additions for Intel QPI CTLE needed.
15	Datasheet Volume 2: Device 6-7 Function 0,1,3
16	Datasheet Volume 2: There is a typo on E5-1600/2600 (Section 3.2.5.48 LNKCAP: PCI Express Link Capabilities)

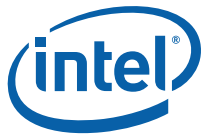

BIOS ACM and SINIT ACM Errata Summary

Table 2. SINIT ACM Errata Table

Number	ACM Release		Status	ERRATA Description
	1.0	1.1		
1				SINIT ACM Erratum Removed
2				SINIT ACM Erratum Removed
3	X		Fixed	SINIT ACM Does Not Support the ACPI 2.0 64-bit XSDT table
4				SINIT ACM Erratum Removed
5				SINIT ACM Erratum Removed
6	X		Fixed	SENDER may not identify incorrectly programmed Intel(R) QuickData Technology Base Address Registers
7	X		Fixed	SENDER Performs Incorrect Checks on TPM Locality 1 and 4

Table 3. BIOS ACM Errata Table

Number	ACM Release						Status	ERRATA Description
	1.0	1.1	1.2	1.3	1.4B	1.4E		
1								BIOS ACM Erratum Removed.
2								BIOS ACM Erratum Removed.
3								BIOS ACM Erratum Removed.
4								BIOS ACM Erratum Removed.
5	X						Fixed	BIOS ACM Unexpected Write to the PCI F000 Segment and S3 Resume Failure.
6	X	X					Fixed	TPM Errors may cause the BIOS ACM to hang
7	X	X					Fixed	TPM Policy Record with MMIO May Not Behave as Expected
8	X	X					Fixed	Intel TXT Policy Record with MMIO May Not Behave as Expected
9	X	X					Fixed	Intel TXT Policy May Not Default to Enabled
10	X	X	X				Fixed	Intel® Trusted Execution Technology BIOS ACM leaves Memory locked When the Coin Battery is removed and the TPM is not populated
11	X	X	X				Fixed	BIOS ACM errors may result in unexpected TPM locality change command
12	X	X	X				Fixed	BIOS ACM Error Condition May Result In Unexpected Behavior
13	X	X	X	X			Fixed	Reset due to Intel® Trusted Execution Technology Error Condition May Result in BIOS Hang or Unexpected Behavior
14	X	X	X	X			Fixed	BIOS ACM Changes to the PCI Configuration Space May Cause Unexpected Behavior
15	X	X	X	X	X		Fixed	TPM Hang May Result in BIOS Hang or Other Unexpected Behavior

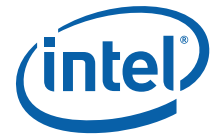

Intel® Trusted Execution Technology Authenticated Control Modules

Platforms supporting Intel® Trusted Execution Technology (Intel® TXT) must ship with authenticated control modules, software binaries used to establish a root of trust.

BIOS launches the BIOS ACM (authenticated control module) to establish a static root of trust at power-on. The measured launch environment launches the SINIT ACM to establish a dynamic root of trust at MLE (Measured Launch Event) launch.

Table 4. Intel® Xeon® Processor E5 Family BIOS ACM Releases

Version	Release Date	Location	Description
1.0	December 2011	No Longer Available	Replaced
1.1	February 2012	No Longer Available	Replaced
1.2	March 2012	No Longer Available	Replaced
1.3	March 2012	No Longer Available	Replaced
1.4B	April 2012	No Longer Available	Replaced
1.4E	May 2012	No Longer Available	Replaced
2.2	May 2012	Contact your Intel representative for the latest revision and order number of this document	Current Production Release

Table 5. Intel® Xeon® Processor E5 Family SINIT ACM Releases

Version	Release Date	Location	Description
1.0	December 2011	No Longer Available	Replaced
1.1	March 2012	No Longer Available	Replaced
2.2	May 2013	Contact your Intel representative for the latest revision and order number of this document	Current Production Release



Identification Information

Component Identification via Programming Interface

The Intel® Xeon® Processor E5 Family stepping can be identified by the following register contents:

Reserved	Extended Family ^{1, 6}	Extended Model ^{2, 6}	Reserved	Processor Type	Family Code ^{3, 6}	Model Number ^{4, 6}	Stepping ID ^{5, 6}
31:28	27:20	19:16	15:14	13:12	11:8	7:4	3:0
	00000000b	0010b		00b	0110b	1101b	C1=0110b M0=0110b C2=0111b M1=0111b

Notes:

1. The Extended Family, Bits [27:20] are used in conjunction with the Family Code, specified in Bits [11:8], to indicate whether the processor belongs to the Intel386™, Intel486™, Pentium®, Pentium 4, or Intel® Core™ processor family.
2. The Extended Model, Bits [19:16] in conjunction with the Model Number, specified in Bits [7:4], are used to identify the model of the processor within the processor's family.
3. The Family Code corresponds to Bits [11:8] of the EDX register after RESET, Bits [11:8] of the EAX register after the CPUID instruction is executed with a 1 in the EAX register, and the generation field of the Device ID register accessible through Boundary Scan.
4. The Model Number corresponds to Bits [7:4] of the EDX register after RESET, Bits [7:4] of the EAX register after the CPUID instruction is executed with a 1 in the EAX register, and the model field of the Device ID register accessible through Boundary Scan.
5. The Stepping ID in Bits [3:0] indicates the revision number of that model.

When EAX is initialized to a value of '1', the CPUID instruction returns the *Extended Family, Extended Model, Processor Type, Family Code, Model Number and Stepping ID* value in the EAX register. Note that the EDX processor signature value after reset is equivalent to the processor signature output value in the EAX register.

Cache and TLB descriptor parameters are provided in the EAX, EBX, ECX and EDX registers after the CPUID instruction is executed with a 2 in the EAX register.

Component Marking Information

The Intel® Xeon® Processor E5 Family can be identified by the following component markings:

Figure 1. Production Top-side Markings (Example)

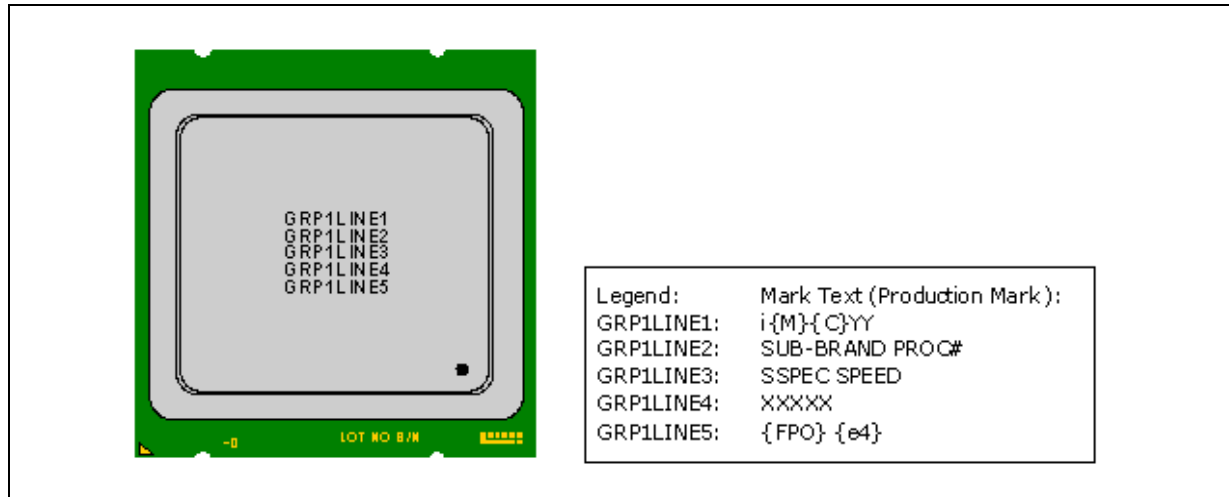

Table 6. Intel® Xeon® Processor E5-1600 and E5-2600 Product Families Identification (Sheet 1 of 4)

S-Spec Number	Stepping	Model Number	CPUID	Core Frequency (GHz)/ DDR3(MHz)/ Intel® QPI (GHz)	Available bins of Intel® Turbo Boost Technology	TDP (W)	# Cores	Cache Size (MB)	Notes
SR0HA	C-1	E5-2690	0x206D6	2.9/1600/8.0	4/4/4/5/5/7/7/9	135	8	20	1, 2, 3, 4, 6
SR0GY	C-1	E5-2680	0x206D6	2.7/1600/8.0	4/4/5/5/5/7/8/8	130	8	20	1, 2, 3, 4, 6
SR0H8	C-1	E5-2670	0x206D6	2.6/1600/8.0	4/4/5/5/6/6/7/7	115	8	20	1, 2, 3, 4, 6
SR0H3	C-1	E5-2667	0x206D6	2.9/1600/8.0	3/3/3/4/5/6	130	6	15	1, 2, 3, 4, 6
SR0GZ	C-1	E5-2660	0x206D6	2.2/1600/8.0	5/5/6/6/7/7/8/8	95	8	20	1, 2, 3, 4, 6
SR0H4	C-1	E5-2650	0x206D6	2.0/1600/8.0	4/4/5/5/5/7/8/8	95	8	20	1, 2, 3, 4, 6
SR0H0	C-1	E5-2650L	0x206D6	1.8/1600/8.0	2/2/3/3/4/4/5/5	70	8	20	1, 2, 3, 4, 6
SR0H5	C-1	E5-2640	0x206D6	2.5/1333/7.2	3/3/4/4/5/5	95	6	15	1, 2, 3, 4, 6
SR0H6	C-1	E5-2630	0x206D6	2.3/1333/7.2	3/3/4/4/5/5	95	6	15	1, 2, 3, 4, 6
SR0H1	C-1	E5-2630L	0x206D6	2.0/1333/8.0	3/3/4/4/5/5	60	6	15	1, 2, 3, 4, 6
SR0H7	C-1	E5-2620	0x206D6	2.0/1333/7.2	3/3/4/4/5/5	95	6	15	1, 2, 3, 4, 6
SR0L0	C-2	E5-2690	0x206D7	2.9/1600/8.0	4/4/4/5/5/7/7/9	135	8	20	1, 2, 3, 4
SR0KG	C-2	E5-2687W	0x206D7	3.1/1600/8.0	3/3/3/4/4/5/5/7	150	8	20	1, 2, 3, 4, 5
SR0KH	C-2	E5-2680	0x206D7	2.7/1600/8.0	4/4/5/5/5/7/8/8	130	8	20	1, 2, 3, 4
SR0KX	C-2	E5-2670	0x206D7	2.6/1600/8.0	4/4/5/5/6/6/7/7	115	8	20	1, 2, 3, 4
SR0KP	C-2	E5-2667	0x206D7	2.9/1600/8.0	3/3/3/4/5/6	130	6	15	1, 2, 3, 4
SR0L1	C-2	E5-2665	0x206D7	2.4/1600/8.0	4/4/5/5/6/6/7/7	115	8	20	1, 2, 3, 4
SR0KK	C-2	E5-2660	0x206D7	2.2/1600/8.0	5/5/6/6/7/7/8/8	95	8	20	1, 2, 3, 4



Table 6. Intel® Xeon® Processor E5-1600 and E5-2600 Product Families Identification (Sheet 1 of 4)

S-Spec Number	Stepping	Model Number	CPUID	Core Frequency (GHz)/ DDR3(MHz)/ Intel® QPI (GHz)	Available bins of Intel® Turbo Boost Technology	TDP (W)	# Cores	Cache Size (MB)	Notes
SR0LZ	C-2	E5-2658	0x206D7	2.1/1600/8.0	0/0/1/1/2/2/3/3	95	8	20	1, 2, 3, 4
SR0KQ	C-2	E5-2650	0x206D7	2.0/1600/8.0	4/4/5/5/5/7/8/8	95	8	20	1, 2, 3, 4
SR0KL	C-2	E5-2650L	0x206D7	1.8/1600/8.0	2/2/3/3/4/4/5/5	70	8	20	1, 2, 3, 4
SR0LX	C-2	E5-2648L	0x206D7	1.8/1600/8.0	0/0/1/1/2/2/3/3	70	8	20	1, 2, 3, 4
SR0L7	M-1	E5-2643	0x206D7	3.3/1600/6.4	1/1/2/2	130	4	10	1, 2, 3, 4
SR0KR	C-2	E5-2640	0x206D7	2.5/1333/7.2	3/3/4/4/5/5	95	6	15	1, 2, 3, 4
SR0LE	M-1	E5-2637	0x206D7	3.0/1066/6.4	5/5	80	2	5	1, 2, 3, 4
SR0KV	C-2	E5-2630	0x206D7	2.3/1333/7.2	3/3/4/4/5/5	95	6	15	1, 2, 3, 4
SR0KM	C-2	E5-2630L	0x206D7	2.0/1333/8.0	3/3/4/4/5/5	60	6	15	1, 2, 3, 4
SR0KW	C-2	E5-2620	0x206D7	2.0/1333/7.2	3/3/4/4/5/5	95	6	15	1, 2, 3, 4
SR0LA	M-1	E5-2609	0x206D7	2.4/1066/6.4	N/A	80	4	10	1, 2, 3
SR0LB	M-1	E5-2603	0x206D7	1.8/1066/6.4	N/A	80	4	10	1, 2, 3
SR0KN	C-2	E5-1660	0x206D7	3.3/1600	3/3/4/4/6/6	130	6	15	1, 2, 3, 4, 7
SR0KZ	C-2	E5-1650	0x206D7	3.2/1600	3/3/4/5/6/6	130	6	12	1, 2, 3, 4, 7
SR0LC	M-1	E5-1620	0x206D7	3.6/1600	1/1/2/2	130	4	10	1, 2, 3, 4, 7

Notes:

1. Intel® Xeon® Processor E5-1600 and E5-2600 Product Families VID codes will change due to temperature and/or current load changes in order to minimize the power of the part. For specific voltages please refer to the latest Intel® Xeon® Processor E5-1600/E5-2600/E5-4600 Product Families Datasheet - Volume One, #326508-002.
2. Please refer to the latest Intel® Xeon® Processor E5-1600/E5-2600/E5-4600 Product Families Datasheet - Volume One, #326508-002 and Intel® Xeon® Processor E5-1600/E5-2400/E5-2600/E5-4600 Product Families Datasheet - Volume Two, #326509-003, for information on processor specifications and features.
3. Please refer to the latest Intel® Xeon® Processor E5-1600/E5-2600/E5-4600 Product Families Datasheet - Volume One, #326508-002, for information on processor operating temperature and thermal specifications.
4. This SKU supports Intel® Turbo Boost Technology. Intel® Turbo Boost Technology performance varies depending on hardware, software and overall system configuration.
5. The 150W TDP SKU is intended for the dual processor workstations only and uses workstation specific use conditions for reliability assumptions.
6. Intel® Trusted Execution Technology (Intel® TXT) is not a supported production feature on the C-1 stepping.
7. LR-DIMMs are not supported on E5-1600 product family SKUs. All E5-1600 SKUs are workstation only.

Table 7. Intel® Xeon® Processor E5-4600 Product Family Identification (Sheet 1 of 2)

S-Spec Number	Stepping	Model Number	CPUID	Core Frequency (GHz)/ DDR3(MHz)/ Intel® QPI (GHz)	Available bins of Intel® Turbo Boost Technology	TDP (W)	# Cores	Cache Size (MB)	Notes
SR0QR	C-2	E5-4650	0x206D7	2.7/1600/8.0	2/2/3/3/3/5/6/6	130	8	20	1, 2, 3, 4, 5
SR0QS	C-2	E5-4650L	0x206D7	2.6/1600/8.0	2/2/3/3/4/4/5/5	115	8	20	1, 2, 3, 4, 5
SR0QT	C-2	E5-4640	0x206D7	2.4/1600/8.0	1/1/2/2/3/3/4/4	95	8	20	1, 2, 3, 4, 5
SR0L4	C-2	E5-4620	0x206D7	2.2/1333/7.2	1/1/2/2/3/3/4/4	95	8	16	1, 2, 3, 4
SR0L5	C-2	E5-4617	0x206D7	2.9/1600/7.2	3/3/4/4/5/5	130	6	15	1, 2, 3, 4, 6
SR0KS	C-2	E5-4610	0x206D7	2.4/1333/7.2	3/3/4/4/5/5	95	6	15	1, 2, 3, 4
SR0KU	C-2	E5-4607	0x206D7	2.2/1066/6.4	N/A	95	6	12	1, 2, 3,
SR0LF	M-1	E5-4603	0x206D7	2.0/1066/6.4	N/A	95	4	10	1, 2, 3,



Notes:

1. Intel® Xeon® Processor E5-4600 Product Family VID codes will change due to temperature and/or current load changes in order to minimize the power of the part. For specific voltages please refer to the latest Intel® Xeon® Processor E5-1600/E5-2600/E5-4600 Product Families Datasheet - Volume One, #326508-002.
2. Please refer to the latest Intel® Xeon® Processor E5-1600/E5-2600/E5-4600 Product Families Datasheet - Volume One, #326508-002 and Intel® Xeon® Processor E5-1600/E5-2400/E5-2600/E5-4600 Product Families External Design Specification (EDS) - Volume Two, #326509-003 for information on processor specifications and features.
3. Please refer to the latest Intel® Xeon® Processor E5-1600/E5-2600/E5-4600 Product Families Datasheet - Volume One, #326508-002, for information on processor operating temperature and thermal specifications.
4. This SKU supports Intel® Turbo Boost Technology. Intel® Turbo Boost Technology performance varies depending on hardware, software and overall system configuration.
5. This SKU includes Machine Check Architecture (MCA) Recovery – Execution Path and Non-Execution Path features.
6. This SKU does not support Intel® Hyper-Threading Technology.



Table 8. Intel® Xeon® Processor E5-2400 Product Family Identification (Sheet 1 of 2)

S-Spec Number	Stepping	Model Number	CPUID	Core Frequency (GHz) / DDR3 (MHz) / Intel® QPI (GHz)	Available bins of Intel® Turbo Boost Technology	TDP (W)	# Cores	Cache Size (MB)	Notes
SR0LG	C-2	E5-2470	0x206D7	2.3/1600/8	5/5/6/6/7/7/8/8	95	8	20	1, 2, 3
SR0LJ	C-2	E5-2450	0x206D7	2.1/1600/8	5/5/6/6/7/7/8/8	95	8	20	1, 2, 3
SR0LH	C-2	E5-2450L	0x206D7	1.8/1600/8	2/2/3/3/4/4/5/5	70	8	20	1, 2, 3
SR0M2	C-2	E5-2448L	0x206D7	1.8/1600/8.0	0/0/1/1/2/2/3/3	70	8	20	1, 2, 3
SR0LK	C-2	E5-2440	0x206D7	2.4/1333/7.2	3/3/4/4/5/5	95	6	15	1, 2, 3
SR0LM	C-2	E5-2430	0x206D7	2.2/1333/7.2	3/3/4/4/5/5	95	6	15	1, 2, 3
SR0LL	C-2	E5-2430L	0x206D7	2.0/1333/7.2	3/3/4/4/5/5	60	6	15	1, 2, 3
SR0M3	C-2	E5-2428L	0x206D7	1.8/1333/7.2	0/0/1/1/2/2	60	6	15	1, 2, 3
SR0LN	C-2	E5-2420	0x206D7	1.9/1333/7.2	3/3/4/4/5/5	95	6	15	1, 2, 3
SR0M5	M-1	E5-2418L	0x206D7	2.0/1333/7.2	0/0/1/1	50	4	10	1, 2, 3
SR0LR	M-1	E5-2407	0x206D7	2.2/1066/6.4	N/A	80	4	10	1, 2, 3
SR0LS	M-1	E5-2403	0x206D7	1.8/1066/6.4	N/A	80	4	10	1, 2, 3
SR0M4	C-2	E5-1428L	0x206D7	1.8/1333	N/A	60	6	15	1, 2, 3

Notes:

1. Intel® Xeon® Processor E5-2400 Product Family VID codes will change due to temperature and/or current load changes in order to minimize the power of the part. For specific voltages please refer to the latest Intel® Xeon® E5-2400 Product Family Datasheet- Volume One, #327248-001.
2. Please refer to the latest Intel® Xeon® E5-2400 Product Family Datasheet- Volume One, #327248-001 and Intel® Xeon® Processor E5-1600/E5-2400/E5-2600/E5-4600 Product Families Datasheet - Volume Two, #326509-003, for information on processor specifications and features.
3. Please refer to the latest Intel® Xeon® E5-2400 Product Family Datasheet- Volume One, 327248-001, for information on processor operating temperature and thermal specifications.



Errata

BT1. An Enabled Debug Breakpoint or Single Step Trap May Be Taken after MOV SS/POP SS Instruction if it is Followed by an Instruction That Signals a Floating Point Exception

Problem: A MOV SS/POP SS instruction should inhibit all interrupts including debug breakpoints until after execution of the following instruction. This is intended to allow the sequential execution of MOV SS/POP SS and MOV [r/e]SP, [r/e]BP instructions without having an invalid stack during interrupt handling. However, an enabled debug breakpoint or single step trap may be taken after MOV SS/POP SS if this instruction is followed by an instruction that signals a floating point exception rather than a MOV [r/e]SP, [r/e]BP instruction. This results in a debug exception being signaled on an unexpected instruction boundary since the MOV SS/POP SS and the following instruction should be executed atomically.

Implication: This can result in incorrect signaling of a debug exception and possibly a mismatched Stack Segment and Stack Pointer. If MOV SS/POP SS is not followed by a MOV [r/e]SP, [r/e]BP, there may be a mismatched Stack Segment and Stack Pointer on any exception. Intel has not observed this erratum with any commercially available software or system.

Workaround: As recommended in the *IA32 Intel® Architecture Software Developer's Manual*, the use of MOV SS/POP SS in conjunction with MOV [r/e]SP, [r/e]BP will avoid the failure since the MOV [r/e]SP, [r/e]BP will not generate a floating point exception. Developers of debug tools should be aware of the potential incorrect debug event signaling created by this erratum.

Status: For the affected steppings, see the Summary Tables of Changes.

BT2. APIC Error “Received Illegal Vector” May be Lost

Problem: APIC (Advanced Programmable Interrupt Controller) may not update the ESR (Error Status Register) flag Received Illegal Vector bit [6] properly when an illegal vector error is received on the same internal clock that the ESR is being written (as part of the write-read ESR access flow). The corresponding error interrupt will also not be generated for this case.

Implication: Due to this erratum, an incoming illegal vector error may not be logged into ESR properly and may not generate an error interrupt.

Workaround: None identified.

Status: For the affected steppings, see the Summary Tables of Changes.

BT3. An Uncorrectable Error Logged in IA32_CR_MC2_STATUS May also Result in a System Hang

Problem: Uncorrectable errors logged in IA32_CR_MC2_STATUS MSR (409H) may also result in a system hang causing an Internal Timer Error (MCACOD = 0x0400h) to be logged in another machine check bank (IA32_MCi_STATUS).

Implication: Uncorrectable errors logged in IA32_CR_MC2_STATUS can further cause a system hang and an Internal Timer Error to be logged.

Workaround: None identified.

Status: For the affected steppings, see the Summary Tables of Changes.

BT4. B0-B3 Bits in DR6 For Non-Enabled Breakpoints May be Incorrectly Set

Problem: Some of the B0-B3 bits (breakpoint conditions detect flags, bits [3:0]) in DR6 may be incorrectly set for non-enabled breakpoints when the following sequence happens:

1. MOV or POP instruction to SS (Stack Segment) selector;



2. Next instruction is FP (Floating Point) that gets FP assist
3. Another instruction after the FP instruction completes successfully
4. A breakpoint occurs due to either a data breakpoint on the preceding instruction or a code breakpoint on the next instruction.

Due to this erratum a non-enabled breakpoint triggered on step 1 or step 2 may be reported in B0-B3 after the breakpoint occurs in step 4.

Implication: Due to this erratum, B0-B3 bits in DR6 may be incorrectly set for non-enabled breakpoints.

Workaround: Software should not execute a floating point instruction directly after a MOV SS or POP SS instruction.

Status: For the affected steppings, see the Summary Tables of Changes.

BT5. Changing the Memory Type for an In-Use Page Translation May Lead to Memory-Ordering Violations

Problem: Under complex microarchitectural conditions, if software changes the memory type for data being actively used and shared by multiple threads without the use of semaphores or barriers, software may see load operations execute out of order.

Implication: Memory ordering may be violated. Intel has not observed this erratum with any commercially available software.

Workaround: Software should ensure pages are not being actively used before requesting their memory type be changed.

Status: For the affected steppings, see the Summary Tables of Changes.

BT6. Code Segment Limit/Canonical Faults on RSM May be Serviced before Higher Priority Interrupts/Exceptions and May Push the Wrong Address Onto the Stack

Problem: Normally, when the processor encounters a Segment Limit or Canonical Fault due to code execution, a #GP (General Protection Exception) fault is generated after all higher priority Interrupts and exceptions are serviced. Due to this erratum, if RSM (Resume from System Management Mode) returns to execution flow that results in a Code Segment Limit or Canonical Fault, the #GP fault may be serviced before a higher priority Interrupt or Exception (for example, NMI (Non-Maskable Interrupt), Debug break(#DB), Machine Check (#MC), and so forth). If the RSM attempts to return to a non-canonical address, the address pushed onto the stack for this #GP fault may not match the non-canonical address that caused the fault.

Implication: Operating systems may observe a #GP fault being serviced before higher priority Interrupts and Exceptions. Intel has not observed this erratum on any commercially available software.

Workaround: None identified.

Status: For the affected steppings, see the Summary Tables of Changes.

BT7. Corruption of CS Segment Register During RSM While Transitioning From Real Mode to Protected Mode

Problem: During the transition from real mode to protected mode, if an SMI (System Management Interrupt) occurs between the MOV to CR0 that sets PE (Protection Enable, bit 0) and the first far JMP, the subsequent RSM (Resume from System Management Mode) may cause the lower two bits of CS segment register to be corrupted.

Implication: The corruption of the bottom two bits of the CS segment register will have no impact unless software explicitly examines the CS segment register between enabling protected mode and the first far JMP. *Intel® 64 and IA-32 Architectures Software Developer's Manual Volume 3A: System Programming Guide, Part 1*, in the section

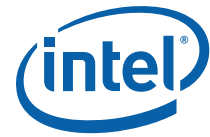

titled "Switching to Protected Mode" recommends the far JMP immediately follows the write to CR0 to enable protected mode. Intel has not observed this erratum with any commercially available software.

Workaround: None identified.

Status: For the affected steppings, see the Summary Tables of Changes.

BT8. Debug Exception Flags DR6.B0-B3 Flags May be Incorrect for Disabled Breakpoints

Problem: When a debug exception is signaled on a load that crosses cache lines with data forwarded from a store and whose corresponding breakpoint enable flags are disabled (DR7.G0-G3 and DR7.L0-L3), the DR6.B0-B3 flags may be incorrect.

Implication: The debug exception DR6.B0-B3 flags may be incorrect for the load if the corresponding breakpoint enable flag in DR7 is disabled.

Workaround: None identified.

Status: For the affected steppings, see the Summary Tables of Changes.

BT9. DR6 May Contain Incorrect Information When the First Instruction After a MOV SS,r/m or POP SS is a Store

Problem: Normally, each instruction clears the changes in DR6 (Debug Status Register) caused by the previous instruction. However, the instruction following a MOV SS,r/m (MOV to the stack segment selector) or POP SS (POP stack segment selector) instruction will not clear the changes in DR6 because data breakpoints are not taken immediately after a MOV SS,r/m or POP SS instruction. Due to this erratum, any DR6 changes caused by a MOV SS,r/m or POP SS instruction may be cleared if the following instruction is a store.

Implication: When this erratum occurs, incorrect information may exist in DR6. This erratum will not be observed under normal usage of the MOV SS,r/m or POP SS instructions (that is, following them with an instruction that writes [e/r]SP). When debugging or when developing debuggers, this behavior should be noted.

Workaround: None identified.

Status: For the affected steppings, see the Summary Tables of Changes.

BT10. EFLAGS Discrepancy on Page Faults and on EPT-Induced VM Exits after a Translation Change

Problem: This erratum is regarding the case where paging structures are modified to change a linear address from writable to non-writable without software performing an appropriate TLB invalidation. When a subsequent access to that address by a specific instruction (ADD, AND, BTC, BTR, BTS, CMPXCHG, DEC, INC, NEG, NOT, OR, ROL/ROR, SAL/SAR/SHL/SHR, SHLD, SHRD, SUB, XOR, and XADD) causes a page fault or an EPT-induced VM exit, the value saved for EFLAGS may incorrectly contain the arithmetic flag values that the EFLAGS register would have held had the instruction completed without fault or VM exit. For page faults, this can occur even if the fault causes a VM exit or if its delivery causes a nested fault.

Implication: None identified. Although the EFLAGS value saved by an affected event (a page fault or an EPT-induced VM exit) may contain incorrect arithmetic flag values, Intel has not identified software that is affected by this erratum. This erratum will have no further effects once the original instruction is restarted because the instruction will produce the same results as if it had initially completed without fault or VM exit.

Workaround: If the handler of the affected events inspects the arithmetic portion of the saved EFLAGS value, then system software should perform a synchronized paging structure modification and TLB invalidation.

Status: For the affected steppings, see the Summary Tables of Changes.

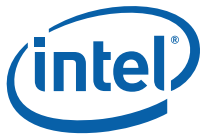

BT11. Fault on ENTER Instruction May Result in Unexpected Values on Stack Frame

Problem: The ENTER instruction is used to create a procedure stack frame. Due to this erratum, if execution of the ENTER instruction results in a fault, the dynamic storage area of the resultant stack frame may contain unexpected values (that is, residual stack data as a result of processing the fault).

Implication: Data in the created stack frame may be altered following a fault on the ENTER instruction. Please refer to "Procedure Calls For Block-Structured Languages" in *IA-32 Intel® Architecture Software Developer's Manual, Vol. 1, Basic Architecture*, for information on the usage of the ENTER instructions. This erratum is not expected to occur in ring 3. Faults are usually processed in ring 0 and stack switch occurs when transferring to ring 0. Intel has not observed this erratum on any commercially available software.

Workaround: None identified.

Status: For the affected steppings, see the Summary Tables of Changes.

BT12. Faulting MMX Instruction May Incorrectly Update x87 FPU Tag Word

Problem: Under a specific set of conditions, MMX stores (MOVD, MOVQ, MOVNTQ, MASKMOVQ) which cause memory access faults (#GP, #SS, #PF, or #AC), may incorrectly update the x87 FPU tag word register.

This erratum will occur when the following additional conditions are also met.

- The MMX store instruction must be the first MMX instruction to operate on x87 FPU state (that is, the x87 FP tag word is not already set to 0x0000).
- For MOVD, MOVQ, MOVNTQ stores, the instruction must use an addressing mode that uses an index register (this condition does not apply to MASKMOVQ).

Implication: If the erratum conditions are met, the x87 FPU tag word register may be incorrectly set to a 0x0000 value when it should not have been modified.

Workaround: None identified.

Status: For the affected steppings, see the Summary Tables of Changes.

BT13. FREEZE_WHILE_SMM Does Not Prevent Event From Pending PEBS During SMM

Problem: In general, a PEBS record should be generated on the first count of the event after the counter has overflowed. However, IA32_DEBUGCTL_MSR.FREEZE_WHILE_SMM (MSR 1D9H, bit [14]) prevents performance counters from counting during SMM (System Management Mode). Due to this erratum, if:

1. A performance counter overflowed before an SMI
2. A PEBS record has not yet been generated because another count of the event has not occurred
3. The monitored event occurs during SMM

then a PEBS record will be saved after the next RSM instruction.

When FREEZE_WHILE_SMM is set, a PEBS should not be generated until the event occurs outside of SMM.

Implication: A PEBS record may be saved after an RSM instruction due to the associated performance counter detecting the monitored event during SMM; even when FREEZE_WHILE_SMM is set.

Workaround: None identified.

Status: For the affected steppings, see the Summary Tables of Changes.



BT14. General Protection Fault (#GP) for Instructions Greater than 15 Bytes May be Preempted

Problem: When the processor encounters an instruction that is greater than 15 bytes in length, a #GP is signaled when the instruction is decoded. Under some circumstances, the #GP fault may be preempted by another lower priority fault (for example, Page Fault (#PF)). However, if the preempting lower priority faults are resolved by the operating system and the instruction retried, a #GP fault will occur.

Implication: Software may observe a lower-priority fault occurring before or in lieu of a #GP fault. Instructions of greater than 15 bytes in length can only occur if redundant prefixes are placed before the instruction.

Workaround: None identified.

Status: For the affected steppings, see the Summary Tables of Changes.

BT15. #GP on Segment Selector Descriptor that Straddles Canonical Boundary May Not Provide Correct Exception Error Code

Problem: During a #GP (General Protection Exception), the processor pushes an error code on to the exception handler's stack. If the segment selector descriptor straddles the canonical boundary, the error code pushed onto the stack may be incorrect.

Implication: An incorrect error code may be pushed onto the stack. Intel has not observed this erratum with any commercially available software.

Workaround: None identified.

Status: For the affected steppings, see the Summary Tables of Changes.

BT16. IO_SMI Indication in SMRAM State Save Area May be Set Incorrectly

Problem: The IO_SMI bit in SMRAM's location 7FA4H is set to "1" by the CPU to indicate a System Management Interrupt (SMI) occurred as the result of executing an instruction that reads from an I/O port. Due to this erratum, the IO_SMI bit may be incorrectly set by:

- A non-I/O instruction
- SMI is pending while a lower priority event interrupts
- A REP I/O read
- A I/O read that redirects to MWAIT

Implication: SMM handlers may get false IO_SMI indication.

Workaround: The SMM handler has to evaluate the saved context to determine if the SMI was triggered by an instruction that read from an I/O port. The SMM handler must not restart an I/O instruction if the platform has not been configured to generate a synchronous SMI for the recorded I/O port address.

Status: For the affected steppings, see the Summary Tables of Changes.

BT17. IRET under Certain Conditions May Cause an Unexpected Alignment Check Exception

Problem: In IA-32e mode, it is possible to get an Alignment Check Exception (#AC) on the IRET instruction even though alignment checks were disabled at the start of the IRET. This can only occur if the IRET instruction is returning from CPL3 code to CPL3 code. IRETs from CPL0/1/2 are not affected. This erratum can occur if the EFLAGS value on the stack has the AC flag set, and the interrupt handler's stack is misaligned. In IA-32e mode, RSP is aligned to a 16-byte boundary before pushing the stack frame.

Implication: In IA-32e mode, under the conditions given above, an IRET can get a #AC even if alignment checks are disabled at the start of the IRET. This erratum can only be observed with a software generated stack frame.

Workaround: Software should not generate misaligned stack frames for use with IRET.

Status: For the affected steppings, see the Summary Tables of Changes.



BT18. LER MSRs May Be Unreliable

Problem: Due to certain internal processor events, updates to the LER (Last Exception Record) MSRs, MSR_LER_FROM_LIP (1DDH) and MSR_LER_TO_LIP (1DEH), may happen when no update was expected.

Implication: The values of the LER MSRs may be unreliable.

Workaround: None Identified.

Status: For the affected steppings, see the Summary Tables of Changes.

BT19. LBR, BTS, BTM May Report a Wrong Address when an Exception/Interrupt Occurs in 64-bit Mode

Problem: An exception/interrupt event should be transparent to the LBR (Last Branch Record), BTS (Branch Trace Store) and BTM (Branch Trace Message) mechanisms. However, during a specific boundary condition where the exception/interrupt occurs right after the execution of an instruction at the lower canonical boundary (0x00007FFFFFFFFF) in 64-bit mode, the LBR return registers will save a wrong return address with bits 63 to 48 incorrectly sign extended to all 1's. Subsequent BTS and BTM operations which report the LBR will also be incorrect.

Implication: LBR, BTS and BTM may report incorrect information in the event of an exception/interrupt.

Workaround: None identified.

Status: For the affected steppings, see the Summary Tables of Changes.

BT20. MCI_Status Overflow Bit May Be Incorrectly Set on a Single Instance of a DTLB Error

Problem: A single Data Translation Look Aside Buffer (DTLB) error can incorrectly set the Overflow (bit [62]) in the MCI_Status register. A DTLB error is indicated by MCA error code (bits [15:0]) appearing as binary value, 000x 0000 0001 0100, in the MCI_Status register.

Implication: Due to this erratum, the Overflow bit in the MCI_Status register may not be an accurate indication of multiple occurrences of DTLB errors. There is no other impact to normal processor functionality.

Workaround: None identified.

Status: For the affected steppings, see the Summary Tables of Changes.

BT21. MONITOR or CLFLUSH on the Local xAPIC's Address Space Results in Hang

Problem: If the target linear address range for a MONITOR or CLFLUSH is mapped to the local xAPIC's address space, the processor will hang.

Implication: When this erratum occurs, the processor will hang. The local xAPIC's address space must be uncached. The MONITOR instruction only functions correctly if the specified linear address range is of the type write-back. CLFLUSH flushes data from the cache. Intel has not observed this erratum with any commercially available software.

Workaround: Do not execute MONITOR or CLFLUSH instructions on the local xAPIC address space.

Status: For the affected steppings, see the Summary Tables of Changes.

BT22. MOV To/From Debug Registers Causes Debug Exception

Problem: When in V86 mode, if a MOV instruction is executed to/from a debug registers, a general-protection exception (#GP) should be generated. However, in the case when the general detect enable flag (GD) bit is set, the observed behavior is that a debug exception (#DB) is generated instead.

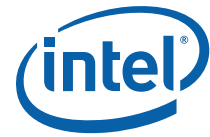

Implication: With debug-register protection enabled (that is, the GD bit set), when attempting to execute a MOV on debug registers in V86 mode, a debug exception will be generated instead of the expected general-protection fault.

Workaround: In general, operating systems do not set the GD bit when they are in V86 mode. The GD bit is generally set and used by debuggers. The debug exception handler should check that the exception did not occur in V86 mode before continuing. If the exception did occur in V86 mode, the exception may be directed to the general-protection exception handler.

Status: For the affected steppings, see the Summary Tables of Changes.

BT23. PEBS Record not Updated when in Probe Mode

Problem: When a performance monitoring counter is configured for PEBS (Precise Event Based Sampling), overflows of the counter can result in storage of a PEBS record in the PEBS buffer. Due to this erratum, if the overflow occurs during probe mode, it may be ignored and a new PEBS record may not be added to the PEBS buffer.

Implication: Due to this erratum, the PEBS buffer may not be updated by overflows that occur during probe mode.

Workaround: None identified.

Status: For the affected steppings, see the Summary Tables of Changes.

BT24. Performance Monitor Counter INST_RETIRED.STORES May Count Higher than Expected

Problem: Performance Monitoring counter INST_RETIRED.STORES (Event: C0H) is used to track retired instructions which contain a store operation. Due to this erratum, the processor may also count other types of instructions including WRMSR and MFENCE.

Implication: Performance Monitoring counter INST_RETIRED.STORES may report counts higher than expected.

Workaround: None identified.

Status: For the affected steppings, see the Summary Tables of Changes.

BT25. Performance Monitoring Event FP_MMX_TRANS_TO_MMX May Not Count Some Transitions

Problem: Performance Monitor Event FP_MMX_TRANS_TO_MMX (Event CCH, Umask 01H) counts transitions from x87 Floating Point (FP) to MMX™ instructions. Due to this erratum, if only a small number of MMX instructions (including EMMS) are executed immediately after the last FP instruction, a FP to MMX transition may not be counted.

Implication: The count value for Performance Monitoring Event FP_MMX_TRANS_TO_MMX may be lower than expected. The degree of undercounting is dependent on the occurrences of the erratum condition while the counter is active. Intel has not observed this erratum with any commercially available software.

Workaround: None Identified.

Status: For the affected steppings, see the Summary Tables of Changes.

BT26. REP MOVS/STOS Executing with Fast Strings Enabled and Crossing Page Boundaries with Inconsistent Memory Types may use an Incorrect Data Size or Lead to Memory-Ordering Violations.

Problem: Under certain conditions as described in the Software Developers Manual section "Out-of-Order Stores For String Operations in Pentium® 4, Intel® Xeon®, and P6 Family Processors" the processor performs REP MOVS or REP STOS as fast strings. Due to this erratum fast string REP MOVS/REP STOS instructions that cross page boundaries from WB/WC memory types to UC/WP/WT memory types, may start using an incorrect data size or may observe memory ordering violations.



Implication: Upon crossing the page boundary the following may occur, dependent on the new page memory type:

- UC the data size of each write will now always be 8 bytes, as opposed to the original data size.
- WP the data size of each write will now always be 8 bytes, as opposed to the original data size and there may be a memory ordering violation.
- WT there may be a memory ordering violation.

Workaround: Software should avoid crossing page boundaries from WB or WC memory type to UC, WP or WT memory type within a single REP MOVSB or REP STOSB instruction that will execute with fast strings enabled.

Status: For the affected steppings, see the Summary Tables of Changes.

BT27. Reported Memory Type May Not Be Used to Access the VMCS and Referenced Data Structures

Problem: Bits 53:50 of the IA32_VMX_BASIC MSR report the memory type that the processor uses to access the VMCS and data structures referenced by pointers in the VMCS. Due to this erratum, a VMX access to the VMCS or referenced data structures will instead use the memory type that the MTRRs (memory-type range registers) specify for the physical address of the access.

Implication: Bits 53:50 of the IA32_VMX_BASIC MSR report that the WB (write-back) memory type will be used but the processor may use a different memory type.

Workaround: Software should ensure that the VMCS and referenced data structures are located at physical addresses that are mapped to WB memory type by the MTRRs.

Status: For the affected steppings, see the Summary Tables of Changes.

BT28. Single Step Interrupts with Floating Point Exception Pending May Be Mishandled

Problem: In certain circumstances, when a floating point exception (#MF) is pending during single-step execution, processing of the single-step debug exception (#DB) may be mishandled.

Implication: When this erratum occurs, #DB will be incorrectly handled as follows:

- #DB is signaled before the pending higher priority #MF (Interrupt 16)
- #DB is generated twice on the same instruction

Workaround: None identified.

Status: For the affected steppings, see the Summary Tables of Changes.

BT29. Storage of PEBS Record Delayed Following Execution of MOV SS or STI

Problem: When a performance monitoring counter is configured for PEBS (Precise Event Based Sampling), overflow of the counter results in storage of a PEBS record in the PEBS buffer. The information in the PEBS record represents the state of the next instruction to be executed following the counter overflow. Due to this erratum, if the counter overflow occurs after execution of either MOV SS or STI, storage of the PEBS record is delayed by one instruction.

Implication: When this erratum occurs, software may observe storage of the PEBS record being delayed by one instruction following execution of MOV SS or STI. The state information in the PEBS record will also reflect the one instruction delay.

Workaround: None identified.

Status: For the affected steppings, see the Summary Tables of Changes.

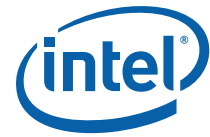

BT30. The Processor May Report a #TS Instead of a #GP Fault

Problem: A jump to a busy TSS (Task-State Segment) may cause a #TS (invalid TSS exception) instead of a #GP fault (general protection exception).

Implication: Operation systems that access a busy TSS may get invalid TSS fault instead of a #GP fault. Intel has not observed this erratum with any commercially available software.

Workaround: None identified.

Status: For the affected steppings, see the Summary Tables of Changes.

BT31. VM Exits Due to “NMI-Window Exiting” May Be Delayed by One Instruction

Problem: If VM entry is executed with the “NMI-window exiting” VM-execution control set to 1, a VM exit with exit reason “NMI window” should occur before execution of any instruction if there is no virtual-NMI blocking, no blocking of events by MOV SS, and no blocking of events by STI. If VM entry is made with no virtual-NMI blocking but with blocking of events by either MOV SS or STI, such a VM exit should occur after execution of one instruction in VMX non-root operation. Due to this erratum, the VM exit may be delayed by one additional instruction.

Implication: VMM software using “NMI-window exiting” for NMI virtualization should generally be unaffected, as the erratum causes at most a one-instruction delay in the injection of a virtual NMI, which is virtually asynchronous. The erratum may affect VMMs relying on deterministic delivery of the affected VM exits.

Workaround: None identified.

Status: For the affected steppings, see the Summary Tables of Changes.

BT32. Values for LBR/BTS/BTM Will be Incorrect after an Exit from SMM

Problem: After a return from SMM (System Management Mode), the CPU will incorrectly update the LBR (Last Branch Record) and the BTS (Branch Trace Store), hence rendering their data invalid. The corresponding data if sent out as a BTM on the system bus will also be incorrect.

Note: This issue would only occur when one of the 3 above mentioned debug support facilities are used.

Implication: The value of the LBR, BTS, and BTM immediately after an RSM operation should not be used.

Workaround: None identified.

Status: For the affected steppings, see the Summary Tables of Changes.

BT33. VPHMINPOSUW Instruction in VEX Format Does Not Signal #UD (Invalid Opcode Exception) When vex.vvvv != 1111

Problem: Processor does not signal #UD fault when executing the reserved instruction VPHMINPOSUW with vex.vvvv!=1111. The VPHMINPOSUW instruction is described in greater detail in the *Intel® Advanced Vector Extensions Programming Reference*.

Implication: Executing VPHMINPOSUW with vex.vvvv != 1111 results in same behavior as vex.vvvv= 1111.

Workaround: SW should not use VPHMINPOSUW with vex.vvvv != 1111 in order to ensure future compatibility.

Status: For the affected steppings, see the Summary Tables of Changes.

BT34. Pending x87 FPU Exceptions (#MF) May be Signaled Earlier Than Expected

Problem: x87 instructions that trigger #MF normally service interrupts before the #MF. Due to this erratum, if an instruction that triggers #MF is executed while Enhanced Intel



SpeedStep® Technology transitions, Intel® Turbo Boost Technology transitions, or Thermal Monitor events occur, the pending #MF may be signaled before pending interrupts are serviced.

Implication: Software may observe #MF being signaled before pending interrupts are serviced.

Workaround: None identified.

Status: For the affected steppings, see the Summary Tables of Changes.

BT35. VMREAD/VMWRITE Instruction May Not Fail When Accessing an Unsupported Field in VMCS

Problem: The *Intel® 64 and IA-32 Architectures Software Developer's Manual, Volume 2B* states that execution of VMREAD or VMWRITE should fail if the value of the instruction's register source operand corresponds to an unsupported field in the VMCS (Virtual Machine Control Structure). The correct operation is that the logical processor will set the ZF (Zero Flag), write 0CH into the VM-instruction error field and for VMREAD leave the instruction's destination operand unmodified. Due to this erratum, the instruction may instead clear the ZF, leave the VM-instruction error field unmodified and for VMREAD modify the contents of its destination operand.

Implication: Accessing an unsupported field in VMCS will fail to properly report an error. In addition, VMREAD from an unsupported VMCS field may unexpectedly change its destination operand. Intel has not observed this erratum with any commercially available software.

Workaround: Software should avoid accessing unsupported fields in a VMCS.

Status: For the affected steppings, see the Summary Tables of Changes.

BT36. Unexpected #UD on VZEROALL/VZEROUPPER

Problem: Execution of the VZEROALL or VZEROUPPER instructions in 64-bit mode with VEX.W set to 1 may erroneously cause a #UD (invalid-opcode exception).

Implication: The affected instructions may produce unexpected invalid-opcode exceptions in 64-bit mode.

Workaround: Compilers should encode VEX.W = 0 for the VZEROALL and VZEROUPPER instructions.

Status: For the affected steppings, see the Summary Tables of Changes.

BT37. Execution of Opcode 9BH with the VEX Opcode Extension May Produce a #NM Exception

Problem: Attempt to use opcode 9BH with a VEX opcode extension should produce a #UD (Invalid-Opcode) exception. Due to this erratum, if CR0.MP and CR0.TS are both 1, the processor may produce a #NM (Device-Not-Available) exception if one of the following conditions exists:

- 66H, F2H, F3H or REX as a preceding prefix;
- An illegal map specified in the VEX.mmmmm field;

Implication: Due to this erratum, some undefined instruction encodings may produce a #NM instead of a #UD exception.

Workaround: Software should not use opcode 9BH with the VEX opcode extension.

Status: For the affected steppings, see the Summary Tables of Changes.

BT38. Erratum Removed

BT39. An Unexpected Page Fault or EPT Violation May Occur After Another Logical Processor Creates a Valid Translation for a Page

Problem: An unexpected page fault (#PF) or EPT violation may occur for a page under the following conditions:

- The paging structures initially specify no valid translation for the page.



- Software on one logical processor modifies the paging structures so that there is a valid translation for the page (for example, by setting to 1 the present bit in one of the paging-structure entries used to translate the page).
- Software on another logical processor observes this modification (for example, by accessing a linear address on the page or by reading the modified paging-structure entry and seeing value 1 for the present bit).
- Shortly thereafter, software on that other logical processor performs a store to a linear address on the page.

In this case, the store may cause a page fault or EPT violation that indicates that there is no translation for the page (for example, with bit 0 clear in the page-fault error code, indicating that the fault was caused by a not-present page). Intel has not observed this erratum with any commercially available software.

Implication: An unexpected page fault may be reported. There are no other side effects due to this erratum.

Workaround: System software can be constructed to tolerate these unexpected page faults. See Section "Propagation of Paging-Structure Changes to Multiple Processors" of Volume 3A of *IA-32 Intel® Architecture Software Developer's Manual*, for recommendations for software treatment of asynchronous paging-structure updates.

Status: For the affected steppings, see the Summary Tables of Changes.

BT40. Execution of FXSAVE or FXRSTOR With the VEX Prefix May Produce a #NM Exception

Problem: Attempt to use FXSAVE or FXRSTOR with a VEX prefix should produce a #UD (Invalid-Opcode) exception. If either the TS or EM flag bits in CR0 are set, a #NM (device-not-available) exception will be raised instead of #UD exception.

Implication: Due to this erratum a #NM exception may be signaled instead of a #UD exception on an FXSAVE or an FXRSTOR with a VEX prefix.

Workaround: Software should not use FXSAVE or FXRSTOR with the VEX prefix.

Status: For the affected steppings, see the Summary Tables of Changes.

BT41. Unexpected #UD on VPEXTRD/VPINSRD

Problem: Execution of the VPEXTRD or VPINSRD instructions outside of 64-bit mode with VEX.W set to 1 may erroneously cause a #UD (invalid-opcode exception).

Implication: The affected instructions may produce unexpected invalid-opcode exceptions outside 64-bit mode.

Workaround: Software should encode VEX.W = 0 for executions of the VPEXTRD and VPINSRD instructions outside 64-bit mode.

Status: For the affected steppings, see the Summary Tables of Changes.

BT42. #GP May be Signaled When Invalid VEX Prefix Precedes Conditional Branch Instructions

Problem: When a 2-byte opcode of a conditional branch (opcodes 0F8xH, for any value of x) instruction resides in 16-bit code-segment and is associated with invalid VEX prefix, it may sometimes signal a #GP fault (illegal instruction length > 15-bytes) instead of a #UD (illegal opcode) fault.

Implication: Due to this erratum, #GP fault instead of a #UD may be signaled on an illegal instruction.

Workaround: None identified.

Status: For the affected steppings, see the Summary Tables of Changes.



BT43. LBR, BTM or BTS Records May have Incorrect Branch From Information After an Enhanced Intel® SpeedStep Technology/T-state/S-state/C1E Transition or Adaptive Thermal Throttling

Problem: The “From” address associated with the LBR (Last Branch Record), BTM (Branch Trace Message) or BTS (Branch Trace Store) may be incorrect for the first branch after a transition of:

- Enhanced Intel SpeedStep® Technology
- T-state (Thermal Monitor states)
- S1-state (ACPI package sleep state)
- C1E (Enhanced C1 Low Power state)
- Adaptive Thermal Throttling

Implication: When the LBRs, BTM or BTS are enabled, some records may have incorrect branch “From” addresses for the first branch after a transition of Enhanced Intel SpeedStep® Technology, T-states, S-states, C1E, or Adaptive Thermal Throttling.

Workaround: None identified.

Status: For the affected steppings, see the Summary Tables of Changes.

BT44. A Write to the IA32_FIXED_CTR1 MSR May Result in Incorrect Value in Certain Conditions

Problem: Under specific internal conditions, if software tries to write the IA32_FIXED_CTR1 MSR (30AH) a value that has all bits [31:1] set while the counter was just about to overflow when the write is attempted (that is, its value was 0xFFFF FFFF FFFF), then due to this erratum the new value in the MSR may be corrupted.

Implication: Due to this erratum, IA32_FIXED_CTR1 MSR may be written with a corrupted value.

Workaround: Software may avoid this erratum by writing zeros to the IA32_FIXED_CTR1 MSR, before the desired write operation.

Status: For the affected steppings, see the Summary Tables of Changes.

BT45. Instruction Fetch May Cause Machine Check if Page Size and Memory Type Was Changed Without Invalidation

Problem: This erratum may cause a machine check error (IA32_MCi_STATUS.MCACOD=0150H) on the fetch of an instruction that crosses a 4-KByte address boundary. It applies only if (1) the 4-KByte linear region on which the instruction begins is originally translated using a 4-KByte page with the WB memory type; (2) the paging structures are later modified so that linear region is translated using a large page (2-MByte, 4-MByte, or 1-GByte) with the UC memory type; and (3) the instruction fetch occurs after the paging-structure modification but before software invalidates any TLB entries for the linear region.

Implication: Due to this erratum an unexpected machine check with error code 0150H may occur, possibly resulting in a shutdown. Intel has not observed this erratum with any commercially available software.

Workaround: Software should not write to a paging-structure entry in a way that would change, for any linear address, both the page size and the memory type. It can instead use the following algorithm: first clear the P flag in the relevant paging-structure entry (for example, PDE); then invalidate any translations for the affected linear addresses; and then modify the relevant paging-structure entry to set the P flag and establish the new page size and memory type.

Status: For the affected steppings, see the Summary Tables of Changes.



BT46. L1 Data Cache Errors May be Logged With Level Set to 1 Instead of 0

Problem: When an L1 Data Cache error is logged in IA32_MCI_STATUS[15:0], which is the MCA Error Code Field, with a cache error type of the format 0000 0001 RRRR TTLL, the LL field may be incorrectly encoded as 01b instead of 00b.

Implication: An error in the L1 Data Cache may report the same LL value as the L2 Cache. Software should not assume that an LL value of 01b is the L2 Cache.

Workaround: None identified.

Status: For the affected steppings, see the Summary Tables of Changes.

BT47. Warm Reset May Leave the System in an Invalid Poisoning State and Could Cause The Feature to be Disabled

Problem: Due to this erratum, the PCIe Poison forwarding enable and Intel® QuickPath Interconnect (Intel® QPI) Poison Enable bits are cleared by warm reset, but other bits related to the Poisoning feature remain set. After the warm reset the system may be in an invalid state in regards to the Poisoning bits. This invalid state may cause the feature to be disabled.

Implication: This invalid state may prevent the propagation of the poisoning indication, effectively disabling the feature.

Workaround: If poisoning is disabled, program the following bits to 0 after reset. If poisoning is enabled, program the following bits to 1 after reset:

The IA32_MCG_CONTAIN.POISON_ENABLE bit (MSR 178H, bit 0). It should be noted that each thread must perform this action.

The IA32_MCG_CONTAIN.POISON_ENABLE (MSR 178H, bit 0).

The POISFEN bit (IOMISCCTRL; CPUBUS(0); Device 5; Function 0; Offset 1C0H; Bit 37).

The DMASK bit (UNCEDMASK; CPUBUS(0); Device 0, 1, 2, 3; Functions 0, 1, 2, 3; Offset 218H; bit 12).

Status: For the affected steppings, see the Summary Tables of Changes.

BT48. VM Entries That Return From SMM Using VMLAUNCH May Not Update The Launch State of the VMCS

Problem: Successful VM entries using the VMLAUNCH instruction should set the launch state of the VMCS to "launched". Due to this erratum, such a VM entry may not update the launch state of the current VMCS if the VM entry is returning from SMM.

Implication: Subsequent VM entries using the VMRESUME instruction with this VMCS will fail. RFLAGS.ZF is set to 1 and the value 5 (indicating VMRESUME with non-launched VMCS) is stored in the VM-instruction error field. This erratum applies only if dual monitor treatment of SMI and SMM is active.

Workaround: It is possible for the BIOS to contain a workaround for this erratum.

Status: For the affected steppings, see the Summary Tables of Changes.

BT49. Interrupt From Local APIC Timer May Not Be Detectable While Being Delivered

Problem: If the local-APIC timer's CCR (current-count register) is 0, software should be able to determine whether a previously generated timer interrupt is being delivered by first reading the delivery-status bit in the LVT timer register and then reading the bit in the IRR (interrupt-request register) corresponding to the vector in the LVT timer register. If both values are read as 0, no timer interrupt should be in the process of being delivered. Due to this erratum, a timer interrupt may be delivered even if the CCR is 0 and the LVT and IRR bits are read as 0. This can occur only if the DCR (Divide



Configuration Register) is greater than or equal to 4. The erratum does not occur if software writes zero to the Initial Count Register before reading the LVT and IRR bits.

Implication: Software that relies on reads of the LVT and IRR bits to determine whether a timer interrupt is being delivered may not operate properly.

Workaround: Software that uses the local-APIC timer must be prepared to handle the timer interrupts, even those that would not be expected based on reading CCR and the LVT and IRR bits; alternatively, software can avoid the problem by writing zero to the Initial Count Register before reading the LVT and IRR bits.

Status: For the affected steppings, see the Summary Tables of Changes.

BT50. Erratum Removed

BT51. Poison Packets Will be Reported to PCIe Port 1a When Forwarded to Port 1b

Problem: With respect to data poisoning, the processor IIO module supports forwarding poisoned information between the coherent interface and PCIe and vice-versa. Also the processor IIO module supports forwarding poisoned data between peer PCIe ports. When the PCIe Ports 1a and 1b are configured as x4, the outbound Poison Error is reported on Port 1a when a poison packet is forwarded to Port 1b.

Implication: When Ports 1a and 1b are configured as x4 ports, Poison Errors reported on the root port are unreliable.

Workaround: None identified.

Status: For the affected steppings, see the Summary Tables of Changes.

BT52. IA32_MCi_ADDR Overwritten in The Case of Multiple Recoverable Instruction Fetch Errors

Problem: The instruction fetch machine check error (MCACOD 0x150) is a SRAR (Software Recoverable Action Required) error. The address of the location with the error is provided in the corresponding IA32_MCi_ADDR MSR. When multiple instruction fetch errors are logged as part of a single machine check event, as indicated by setting of the Overflow (bit 62) in the IA32_MCi_STATUS MSR, then recovery is not possible. Due to this erratum, when multiple instruction fetch errors are logged in the same bank, the IA32_MCi_MISC MSR contains all of the correct information including the proper setting for Overflow (bit 62); however, the IA32_MCi_ADDR MSR is overwritten with a value that corresponds to neither the first or second error.

Implication: When debugging failures associated with the instruction fetch machine check error and the Overflow bit is set, the value in IA32_MCi_ADDR will not be valid.

Workaround: It is possible for the BIOS to contain a workaround for this erratum.

Status: For the affected steppings, see the Summary Tables of Changes.

BT53. The Processor Does not Detect Intel® QuickPath Interconnect (Intel® QPI) RSVD_CHK Field Violations

Problem: According to the Intel QPI specification, if a target agent receives a packet with a non-zero RSVD_CHK field, it should flag it as an "Intel QPI Link Layer detected unsupported/undefined" packet. Due to this erratum, the processor does not check the RSVD_CHK field nor report the expected error.

Implication: The processor will not flag the "Intel QPI Link Layer detected unsupported/undefined" packet error in the case that the RSVD_CHK field is non-zero.

Workaround: None identified.

Status: For the affected steppings, see the Summary Tables of Changes.

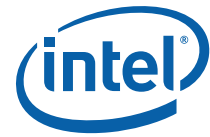

BT54. The Intel QPI Link Status Register LinkInitStatus Field Incorrectly Reports “Internal Stall Link Initialization” For Certain Stall Conditions

Problem: The Intel QPI Link Control register (CPUBUS(1), Devices 8, 9; Function 0; Offset 0x44) bits 17 and 16 allow for the control of the Link Layer Initialization by forcing the link to stall the initialization process until cleared. The Intel QPI Link Status register (CPUBUS(1), Device 8, 9; Function 0; Offset 0x48) bits 27:24 report the Link Initialization Status (LinkInitStatus). The LinkInitStatus incorrectly reports “Internal Stall Link Initialization” (0001b) for non-Intel QPI Link Control register, bit[17,16] stall conditions. The Intel QPI Specification does not intend for internal stall conditions to report that status, but rather report the normal “Waiting for Physical Layer Ready” (0000b).

Implication: There is no known problem with this behavior since there is no usage model that relies on polling of the LinkInitStatus state in the “Waiting for Physical Layer Ready” versus “Internal Stall Link Initialization” state, and it only advertises the “Internal Stall Link Initialization” state for a brief period of time during Link Layer Initialization.

Workaround: None identified.

Status: For the affected steppings, see the Summary Tables of Changes.

BT55. Intel QPI Tx AC Common Mode Fails Specification

Problem: The Intel QPI interface Specification requires Tx AC Common Mode (ACCM) to be between -50 mV to 50 mV at 8.0 GT/s. Testing across process, voltage, and temperature showed that the ACCM exceeded the upper end of the specification on several lanes.

Implication: Those performing an electrical characterization of the Intel QPI interface may notice a violation of the upper end of the ACCM specification by no more than 5 mV.

Workaround: None identified.

Status: For the affected steppings, see the Summary Tables of Changes.

BT56. PROCHOT_N Assertion During Warm Reset May Disable a Processor Via The FRB Mechanism

Problem: FRB (Fault Resilient Booting) is defined as the ability to boot even when one or more processors in the system fail, as long as there is one processor functional. If a warm reset is asserted during the boot flow before the Intel QPI Interface is enumerated and while a processor is hot and drives PROCHOT_N, the processor that is driving PROCHOT_N will mistakenly observe PROCHOT_N as a signal to transition itself into FRB mode.

Implication: It is possible that a processor may be incorrectly isolated via the FRB mechanism if the same processor asserts PROCHOT_N during a warm reset.

Workaround: Case 1: Systems with a BMC

Case 1.1: Legacy Processor gets disabled: The system will not boot. The BMC can detect this case by observing that legacy socket is occupied, but the processor times out on PECI Ping() command. Since BMC knows it did not disable legacy socket, it can assume this is an error case.

Case 1.2: Non-Legacy Processor gets disabled: If system boots with one or more fewer sockets, BMC will observe a discrepancy between socket occupied pins and response to PECI Ping() command. If BMC did not disable the affected socket, it can conclude they were accidentally disabled due to this issue. The BMC can respond to either case by issuing a cold reset to the platform.

Case 2: Systems without a BMC



Case 2.1: Legacy Socket gets disabled: This will prevent booting. The PCH (Platform Control Hub) TCO logic can be strapped to reset the platform if the CPU does not fetch code after reset.

Case 2.2: Non-Legacy Socket gets disabled: BIOS cannot read socket occupied pin from other socket. Therefore, BIOS cannot tell the difference between a tri-stated

socket and unpopulated socket. Enable Autoack in the Intel® QPI Interface Enumeration which will ensure that a warm reset asserted before the Intel® Quick Path Interconnect Enumeration will be converted into a power-cycle reset.

Status: For the affected steppings, see the Summary Tables of Changes.

BT57. The PCIe* Current Compensation Value Default is Incorrect

Problem: The default current compensation values for PCIe buffers may result in non-optimal performance.

Implication: The PCIe buffers will not perform as well as possible and performance could be compromised.

Workaround: A BIOS code change has been identified and may be implemented as a workaround for this erratum.

Status: For the affected steppings, see the Summary Tables of Changes.

BT58. The PCIe* Link at 8.0 GT/s is Transitioning too Soon to Normal Operation While Training

Problem: The PCIe bus uses high speed serial links that must go through a training process to allow both transmitter and receiver to make adjustments in behavior to optimize the signaling between the transmitter and receiver. When a PCIe compliant device must train or retrain the link, training sequences are used. The device must allow enough time for the training to complete before transitioning to normal operation. In the case of PCIe equalization at 8.0 GT/s the processor is not allowing enough time to optimize signaling before attempting normal operation.

Implication: Due to this erratum, unexpected system behavior may be observed.

Workaround: A BIOS code change has been identified and may be implemented as a workaround for this erratum.

Status: For the affected steppings, see the Summary Tables of Changes.

BT59. QPILS Reports the VNA/VN0 Credits Available for the Processor Rx Rather Than Tx

Problem: The QPILS register (CPUBUS(1); Devices 8,9; Function 0; Offset 0x48), according to the *Intel® Quick Path Interconnect Specification* at revisions 1.1 and later, should report the VNA/VN0 credits available for the processor Tx (Transmit port). Due to this erratum, the QPILS register reports the VNA/VN0 credits available for the processor Rx (Receive port).

Implication: This is a violation of the specification but no functional failures have been observed due to this erratum.

Workaround: None identified.

Status: For the affected steppings, see the Summary Tables of Changes.

BT60. The Router Value Exchanged During Intel QPI Link Layer Initialization is Set to Zero

Problem: During the Intel QPI Link Layer initialization, parameters are exchanged by hardware. The parameters that are received are stored by the receiver. The information is used to setup link operation. One of those parameters that is exchanged is the Router value. The Router value should be one but it is zero in the processor.

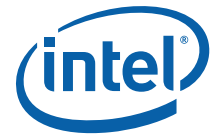

Implication: Given that the processor is designed to only go into 2 socket platforms and that the BIOS is not using this value, there is no known negative impact from the Router value being 0.

Workaround: None identified.

Status: For the affected steppings, see the Summary Tables of Changes.

BT61. A First Level Data Cache Parity Error May Result in Unexpected Behavior

Problem: When a load occurs to a first level data cache line resulting in a parity error in close proximity to other software accesses to the same cache line and other locked accesses the processor may exhibit unexpected behavior.

Implication: Due to this erratum unpredictable system behavior may occur. Intel has not observed this erratum with any commercially available system.

Workaround: None identified.

Status: For the affected steppings, see the Summary Tables of Changes.

BT62. The Processor Incorrectly Indicates That 16-bit Rolling CRC is Supported

Problem: The Intel QPI specification defines two methods of computing CRC: 8-bit CRC or 16-bit rolling CRC. The processor implements only 8-bit CRC. The "CRC Mode supported" bit in the QPILCP registers (Devices 8, 9; Function 0; Offset 40H, bit 11) is set incorrectly indicating that both 8-bit CRC and 16-bit rolling CRC are supported.

Implication: The "CRC Mode supported" bit of QPILCP must be disregarded; there should be no attempt to use 16-bit Rolling CRC mode.

Workaround: The "CRC mode" bits in the QPILCL (Devices 8, 9; Function 0; Offset 44H, Bits[15:14]) should be left at their reset value of 00b to ensure 8-bit CRC is selected.

Status: For the affected steppings, see the Summary Tables of Changes.

BT63. PECCI Write Requests That Require a Retry Will Always Time Out

Problem: PECCI 3.0 introduces a 'Host Identification' field as a way for the PECCI host device to identify itself to the PECCI client. This is intended for use in future PECCI systems that may support more than one PECCI originator. Since PECCI 3.0 systems do not support the use of multiple originators, PECCI 3.0 host devices should zero out the unused Host ID field. PECCI 3.0 also introduces a 'retry' bit as a way for the PECCI host to indicate to the client that the current request is a 'retry' of a previous read or write operation. Unless the PECCI 3.0 host device zeroes out the byte containing the 'Host ID & Retry bit' information, PECCI write requests that require a retry will never complete successfully.

Implication: PECCI write requests that require a retry may never complete successfully. Instead, they will return a timeout completion code of 81H for a period ranging from 1 ms to 30 ms if the 'RETRY' bit is asserted.

Workaround: PECCI 3.0 host devices should zero out the byte that contains the Host ID and Retry bit information for all PECCI requests at all times including retries.

Status: For the affected steppings, see the Summary Tables of Changes.

BT64. The Vswing of the PCIe* Transmitter Exceeds The Specification

Problem: The PCIe Specification defines a limit for the Vswing (Voltage Swing) of the differential lines that make up a lane to be 1200 mV peak-to-peak when operating at 2.5 GT/s and 5 GT/s. Intel has found that the processor's PCIe transmitter may exceed this specification. Peak-to-peak swings on a limited number of samples have been observed up to 1450 mV.

Implication: For those taking direct measurements of the PCIe transmit traffic coming from the processor may detect that the Vswing exceeds the PCIe Specification. Intel has not observed any functional failures due to this erratum.



Workaround: None identified.

Status: For the affected steppings, see the Summary Tables of Changes.

BT65. Intel QPI Interface Calibration May Log Spurious Bus and Interconnect Error Machine Checks

Problem: The Intel QPI interface Physical Layer performs calibration across all 20 of the lanes and reports the success or failure of the calibration process. Due to this erratum, the processor may detect spurious errors during the calibration of the Intel QPI interface. The bus and interconnect errors are reported with the IA32_MCI_STATUS.MCACOD (bits [15:0]) with a value of 0000_1xx0_0000_1111 (where x is zero or one).

Implication: The processor may log spurious bus and interconnect error machine checks reports during Intel QPI calibration.

Workaround: It is possible for the BIOS to contain a workaround for this erratum. A BIOS code change has been identified and may be implemented as a workaround for this erratum.

Status: For the affected steppings, see the Summary Tables of Changes.

BT66. When a Link is Degraded on a Port due to PCIe* Signaling Issues Correctable Receiver Errors May be Reported on The Neighboring Port

Problem: PCI Express* interface incorporates a recovery mechanism when certain link degradation occurs by retraining the link without impacting the pending transactions. When a link is degraded on a specific port due to PCIe signaling issues, it is possible that correctable receiver errors are reported on the neighboring (logically adjacent) port. The correctable receiver errors are indicated by the PCIe AER Correctable error bit (XPGLBERRSTS CPUBUS(0); Device 0-3; Function 0-3; Offset 230H; Bit 2).

Implication: Software that logs errors on the PCIe interface must be aware that errors detected on a specific port could be due to either an error on that specific port or on a neighboring port.

Workaround: None identified.

Status: For the affected steppings, see the Summary Tables of Changes.

BT67. A CMCI is Only Generated When the Memory Controller's Correctable Error Count Threshold is Exceeded

Problem: A CMCI (corrected machine check error interrupt) should be generated when the number of corrected errors for a bank reaches the corrected error threshold programmed into the IA32_MCI_CTL2 bits [14:0]. For memory scrubbing errors, IA32_MCI_STATUS.MCACOD (bits [15:0]) with value of 000x_0000_1100_xxxx (where x stands for zero or one), a CMCI will not be generated until the number of errors has exceeded the threshold in IA32_MCI_CTL2 by 1.

Implication: The CMCI will not be generated when expected but rather will be generated on the next corrected error for the bank.

Workaround: It is possible for BIOS to contain a workaround for this issue. It should be noted that with this workaround if the threshold is programmed to a value of 0, a read of the value will return 1 and the threshold will be 1. All other valid threshold values for the bank will be read back correctly and function as expected.

Status: For the affected steppings, see the Summary Tables of Changes.

BT68. PCIe* Rx DC Common Mode Impedance is Not Meeting the Specification

Problem: When the PCIe Rx termination is not powered, the DC Common Mode impedance has the following requirement: ≥ 10 k Ω over 0-200 mV range with respect to ground and ≥ 20 k Ω for voltages ≥ 200 mV with respect to ground. The processor's PCIe Rx do not meet this requirement at 85 degrees C or greater. In a limited number of samples Intel has measured an impedance as low as 9.85 k Ω at 50 mV.

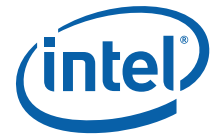

Implication: Intel has not observed any functional impact due to this violation with any commercially available system.

Workaround: None identified.

Status: For the affected steppings, see the Summary Tables of Changes.

BT69. A Modification to the Multiple Message Enable Field Does Not Affect the AER Interrupt Message Number Field

Problem: The (Advanced Error Interrupt) Message Number field (RPERRSTS Devices 0-3; Functions 0-3; Offset 178H; bits[31:27]) should be updated when the number of messages allocated to the root port is changed by writing the Multiple Message Enable field (MSIMSGCTL Device 3; Function 0; Offset 62H; bits[6:4]). However, writing the Multiple Message Enable in the root port does not update the Advanced Error Interrupt Message Number field.

Implication: Due to this erratum, software can allocate only one MSI (Message Signaled Interrupt) to the root port.

Workaround: None identified.

Status: For the affected steppings, see the Summary Tables of Changes.

BT70. Unexpected PCIe* Set_Slot_Power_Limit Message on Writes to LNKCON

Problem: The processor sends the PCIe Set_Slot_Power_Limit message on writes to the Slot Capabilities (SLTCAP Devices 0-3; Functions 0-3; Offset A4H) register. Due to this erratum, the processor also sends PCIe the Set_Slot_Power_Limit message on writes to the LNKCON (CPUBUS(0); Devices 0-3; Functions 0-3; Offset A0H) register.

Implication: For those monitoring the PCIe traffic going across the link, the unexpected PCIe Set_Slot_Power_Limit Message will be detected whenever a write to the LNKCON register occurs. Intel has not observed any functional failures due to this erratum on any commercially available system.

Workaround: None identified.

Status: For the affected steppings, see the Summary Tables of Changes.

BT71. Enabling Intel QPI L0s State May Prevent Entry into L1

Problem: Enabling Intel QPI L0s State in a dual processor system with both processor sockets populated may not allow the Intel QPI Link between the processors to enter the L1 State.

Implication: Entry into the Package C3 State and lower power Package C-states cannot occur if the Intel QPI Link cannot enter the L1 State. System power consumption may increase.

Workaround: It is possible for the BIOS to contain a workaround for this erratum.

Status: For the affected steppings, see the Summary Tables of Changes.

BT72. Erratum Removed

BT73. Locked Accesses Spanning Cachelines That Include PCI Space May Lead to a System Hang

Problem: A locked memory access which splits across a cacheline boundary that suffers a master abort on a PCI bus may lead to a system hang.

Implication: Aborted split lock accesses may cause PCI devices to become inoperable until a platform reset. Intel has not observed this erratum with commercially available software.

Workaround: None identified.

Status: For the affected steppings, see the Summary Tables of Changes.



BT74. Intel QPI Training Sensitivities Related to Clock Detection

Problem: The processor is demonstrating link training sensitivities related to clock detection and will indicate the error with an IA32_MCI_STATUS.MSCOD (bits[21:16]) of 10011 and with an IA32_MCI_STATUS.MCACOD (bits[15:0]) of 0000_1000_0000_1111.

Implication: Due to this erratum, the Intel QPI Interface may train intermittently and flag a machine check error.

Workaround: It is possible for the BIOS to contain a workaround for this erratum.

Status: For the affected steppings, see the Summary Tables of Changes.

BT75. Cold Boot May Fail Due to Internal Timer Error

Problem: The processors may not complete a cold boot (that is, a boot from a power-off state) due to an internal timer error machine check, IA32_MCI_STATUS.MCACOD of 0000_0100_0000_0000. This will result in the processor asserting IERR (Internal Error).

Implication: The processor may signal IERR during a cold boot when the system is initializing.

Workaround: It is possible for the BIOS to contain a workaround for this erratum.

Status: For the affected steppings, see the Summary Tables of Changes.

BT76. PCIe* Rx Common Mode Return Loss is Not Meeting The Specification

Problem: The PCIe specification requires that the Rx Common Mode Return Loss in the range of 0.05 to 2.5 GHz must be limited to -6 dB. The processor's PCIe Rx do not meet this requirement. The PCIe Rx Common Mode Return at 500 MHz has been found to be between -3.5 and -4 dB on a limited number of samples.

Implication: Intel has not observed any functional failures due to this erratum with any commercially available PCIe devices.

Workaround: None identified.

Status: For the affected steppings, see the Summary Tables of Changes.

BT77. The Most Significant Bit of the CEC Cannot be Cleared Once Set

Problem: The most significant bit of the CEC (Corrected Error Count IA32_MCI_STATUS (i=12-19), bit 52) cannot be cleared once it has been set.

Implication: In the case that software attempts to clear the CEC and the count exceeds 3FFFH, software will read incorrect CEC values on subsequent accesses and additional CMCI (Corrected Machine Check Error Interrupts) will not be generated.

Workaround: None identified. Software can avoid this erratum by setting corrected error threshold to a value less than 3FFFH, enable CMCI and clearing the error count before it exceeds 3FFFH.

Status: For the affected steppings, see the Summary Tables of Changes.

BT78. An Unexpected Page Fault or EPT Violation May Occur After Another Logical Processor Creates a Valid Translation for a Page

Problem: An unexpected page fault (#PF) or EPT violation may occur for a page under the following conditions:

- The paging structures initially specify no valid translation for the page.
- Software on one logical processor modifies the paging structures so that there is a valid translation for the page (for example, by setting to 1 the present bit in one of the paging-structure entries used to translate the page).
- Software on another logical processor observes this modification (for example, by accessing a linear address on the page or by reading the modified paging-structure entry and seeing value 1 for the present bit).

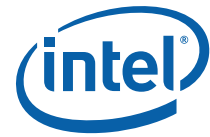

- Shortly thereafter, software on that other logical processor performs a store to a linear address on the page.

In this case, the store may cause a page fault or EPT violation that indicates that there is no translation for the page (for example, with bit 0 clear in the page-fault error code, indicating that the fault was caused by a not-present page). Intel has not observed this erratum with any commercially available software.

Implication: An unexpected page fault may be reported. There are no other side effects due to this erratum.

Workaround: System software can be constructed to tolerate these unexpected page faults. See Section "Propagation of Paging-Structure Changes to Multiple Processors" of Volume 3A of IA-32 Intel® Architecture Software Developer's Manual, for recommendations for software treatment of asynchronous paging-structure updates.

Status: For the affected steppings, see the Summary Tables of Changes.

BT79. PCIe* Adaptive Equalization May Not Train to the Optimal Settings.

Problem: In the case of the PCIe equalization procedure for 8 GT/s, the Downstream Port's (for example, the processor's) TXEQ (transmitter equalization settings) can be fine tuned for each Lane during a process called Adaptive Equalization Phase 3. Due to this erratum, the processor may not direct the end-agent to the optimal TXEQ settings.

Implication: The PCIe link may not be as robust as possible potentially leading to a higher bit error rate than expected.

Workaround: A BIOS code change has been identified and may be implemented as a workaround for this erratum.

Status: For the affected steppings, see the Summary Tables of Changes.

BT80. A Core May Not Complete Transactions to The Caching Agent When C-States Are Enabled Leading to an Internal Timer Error

Problem: When multiple cores have outstanding transactions targeted to a single caching agent and one of the cores enters a Core C-state before completing the transaction with the targeted caching agent an internal timer machine check error may occur (IA32_MCi_STATUS.MCACOD of 0000_0100_0000_0000).

Implication: Due to this erratum, the processor may experience an internal timer error.

Workaround: None identified.

Status: For the affected steppings, see the Summary Tables of Changes.

BT81. TSC is Not Affected by Warm Reset

Problem: The TSC (Time Stamp Counter MSR 10H) should be cleared on reset. Due to this erratum the TSC is not affected by warm reset.

Implication: The TSC is not cleared by a warm reset. The TSC is cleared by power-on reset as expected. Intel has not observed any functional failures due to this erratum.

Workaround: None identified.

Status: For the affected steppings, see the Summary Tables of Changes.

BT82. Warm Resets May be Converted to Power-on Resets When Recovering From an IERR

Problem: When a warm reset is attempted and an IERR (Internal Error) happens as indicated by the IA32_MCi_STATUS.MCACOD of 0000_0100_0000_0000, a power-on reset occurs instead.

Implication: The values in the machine check bank will be lost as a result of the power-on reset. This prevents a OS, BIOS or the BMC (Baseboard Management Controller) from logging the content of the error registers or taking any post-reset actions that are dependent on the machine check information.



Workaround: It is possible for the BIOS to contain a workaround for this erratum.

Status: For the affected steppings, see the Summary Tables of Changes.

BT83. Using DMA XOR With DCA May Cause a Machine Check

Problem: If both DCA (direct cache access) and DMA XOR operations are active at the same time, then invalid prefetch hints may be generated. These prefetch transactions may not complete and could result in a timeout machine check, which will cause CATERR# to become asserted.

Implication: Invalid prefetch hints may not complete resulting in a machine check.

Workaround: If using DMA XOR operations, disable DCA by clearing CHANCTRL.Completion_Write_DCA_Enable (Offset 80H; Bit 9) in the region described by CB_BAR (Device: 10; Function 0-7; Offset 80H).

Status: For the affected steppings, see the Summary Tables of Changes.

BT84. Mixed DMA XOR and Legacy Operations in The Same Channel May Cause Data to be Observed Out of Order

Problem: For mixed channel DMA (XOR and legacy operations active on the same channel) completion writes from legacy operations may pass completion writes from XOR operations resulting in out of order descriptor updates/completions.

Implication: DMA descriptor progress may appear out of order with incorrect data.

Workaround: In the DMA driver each DMA XOR descriptor must be followed by an additional legacy descriptor. The legacy descriptor must have a non-zero transfer length and the "NULL Transfer" bit and "Completion Interrupt" in the Descriptor Control field set to '1'. The transfer will not actually occur, but a completion interrupt will be generated that indicates that the XOR operation has completed. This causes all completion interrupts to be of the legacy type.

Status: For the affected steppings, see the Summary Tables of Changes.

BT85. Unexpected DMA XOR Halt and Errors when Using Descriptors With P or Q Operations Disabled

Problem: If a Galois Field Generate/Validate base descriptor has either the P Operations Disable or Q Operation Disable bit set and the corresponding disabled P Parity Address or Q Parity Address field of the descriptor does not contain a valid/aligned address, the DMA channel may halt unexpectedly with destination address errors. The destination address errors will be logged in CHANERR_INT. DMA Transfer Destination Address Error (Device 4; Function 0-7; Offset 180H; Bit 1).

Implication: The DMA may only partially process a DMA XOR descriptor when a disabled P or Q Parity Address field of the descriptor does not contain a valid/aligned address, resulting in incomplete data, an unexpected DMA channel halt and destination address errors.

Workaround: At all times, software must place a valid/aligned address in both the P Parity Address field and the Q Parity Address field of a DMA XOR with Galois Field Generate/Validate base descriptor even if the P Operations Disable or Q Operations Disable descriptor fields are set to disable either P or Q operations for the descriptor.

Status: For the affected steppings, see the Summary Tables of Changes.

BT86. DMA XOR Channel May Hang on Source Read Completion Data Parity Error For >8K Descriptors

Problem: If a parity error occurs of source read completion data while inside the DMA for >8K descriptor transfer lengths, the DMA channel will hang until the next platform reset. This behavior only applies if the data arrived at the DMA unit error free (from DRAM and Intel QPI) but then had a parity error in the completion data FIFO inside the DMA.

Implication: The effected DMA channel will hang until the next platform reset.

Workaround: None identified.

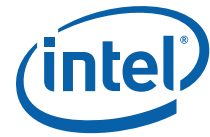

Status: For the affected steppings, see the Summary Tables of Changes.

BT87. DMA CB_BAR Decode May be Incorrect After DMA FLR

Problem: PCIe* FLR (function level reset) of the DMA function, may result in an incorrect CB_BAR (Device 4; Function 0-7; Offset 10h) decode when a memory read of the CB_BAR occurs around the same time as the FLR.

Implication: A FLR may cause a PCIe memory read to decode to channel 0 instead of the intended channel resulting in incorrect read data returned.

Workaround: Software must quiesce the DMA function before issuing FLR including:

- Ensure clients are no longer referencing the driver.
- Ensure all outstanding descriptors have completed via the normal completion writeback notifications by reading CHANCMP, CHANSTS, and DMACOUNT.
- Issue FLR and ensure no new DMA transactions are started until FLR has completed. CHANCMP (Offset 98H) and CHANSTS (Offset 88H), and DMACOUNT (Offset 86H) are offsets relative to CB_BAR on the processor's internal IO bus (as defined in the IIOBUSNO register).

Status: For the affected steppings, see the Summary Tables of Changes.

BT88. XOR DMA Restricted to ≤ 8 KB Transfers When Multiple Channels Are in use

Problem: Incorrect data transfers can occur if more than one DMA channel is in operation and >8 KB XOR DMA transfer sizes are being used. XOR DMA transfer size is set by software in the Block Size field of the XOR with Galios Field Generate/Validate base descriptor.

Implication: XOR DMA operation is restricted to ≤ 8 KB transfer sizes when multiple DMA channels are in use. Legacy DMA operations may still use up to the maximum 1 MB transfer length.

Workaround: Software may either:

- Use a single DMA channel for both legacy and XOR operation types both up to the maximum 1MB transfer size.
- Use multiple DMA channels where XOR operation types are ≤ 8 KB transfer size and legacy operation types are up to 1 MB transfer size.

Status: For the affected steppings, see the Summary Tables of Changes.

BT89. Unable to Restart DMA After Poisoned Error During an XOR Operation

Problem: If the CHANERR field Read Data Error (Offset A8H; Bit 8) is set due to a poisoned completion error during a DMA XOR operation, the DMA stays in the halted state and the Read Data Error bit does not clear

Implication: The XOR operations on the DMA can not be restarted after a read data error due to a poisoned XOR operation.

Workaround: At least one XOR descriptor with no read data errors has to be processed for a new chain of XOR descriptors to work correctly with the corresponding CHANERRMSK (Offset ACH; Bit 8) bit set. Upon detection of a Read Data Error, software must clear the CHANERR and CHANERR_INT (Device 4; Function 0-7; Offset 180H) registers and disable the corresponding error mask bit by setting CHANERRMSK. Then new descriptors can be added to the chain and the DMA started by writing the DMACOUNT (Offset 86H). Once the DMA channel is in the running state, software can clear the CHANERRMSK. CHANERR, CHANERRMSK, and DMACOUNT are offsets relative to CB_BAR (Device 4; Function 0-7; Offset 10H) on the processors internal IO bus (as defined in the IIOBUSNO register).

Status: For the affected steppings, see the Summary Tables of Changes.



BT90. DMA Restart Hang When First Descriptor is a Legacy Type Following Channel HALT Due to an Extended Descriptor Error

Problem: When using multiple DMA channels, all DMA channels may hang if a DMA channel restart is attempted with a Legacy descriptor as the first descriptor following an error/HALT on an Extended descriptor on Channel 0 or 1.

Implication: Following an extended descriptor error on Channel 0 or 1, the channel must be not be restarted with a first descriptor of legacy type including NULL. Does not apply for single channel operation.

Workaround: Software must guarantee that the first descriptor processed on restart is an XOR GF Multiply Generation (base type) before using legacy descriptors with interrupts and completions.

Status: For the affected steppings, see the Summary Tables of Changes.

BT91. JSP CBDMA errata BF508S: Operation With DMA XOR Interrupts/ Completions Enabled Restricted to Channel 0 and 1

Problem: If DMA XOR interrupts and completions are enabled on channel 0 or 1 concurrent with operation on channels 2-7, incorrect data transfers can occur on DMA channels 2-7. DMA XOR interrupts and completions are enabled by setting bits 0 and 3 of descriptor control field of a DMA XOR with Galios Field Generate/Validate base descriptor.

Implication: If DMA XOR interrupts and completions are enabled, only one interrupt/completion type may be used on any single channel and only channels 0 and 1 may be used.

Workaround: Software must either:

- Only use legacy interrupts and completions on all channels.
- Use only DMA channels 0 and 1 where:
 - Only DMA XOR interrupts/completions are enabled on channel 0 and is only used for DMA XOR operations.
 - Only legacy interrupts/completions are enabled on channel 1 and is only used for DMA legacy operations.

Status: For the affected steppings, see the Summary Tables of Changes.

BT92. Suspending/Resetting an Active DMA XOR Channel May Cause an Incorrect Data Transfer on Other Active Channels

Problem: Suspending an active DMA XOR channel by setting CHANCMD.Suspend DMA bit (Offset 84; Bit 2) while XOR type DMA channels are active may cause incorrect data transfer on the other active legacy channels. This erratum may also occur while resetting an active DMA XOR channel CHANCMD.Reset DMA bit (Offset 84; Bit 5). CHANCMD is in the region described by CB_BAR(Device 4; function 0-7; Offset 10H) on the processor's internal IO bus (as defined in the IIOBUSNO register).

Implication: An incorrect data transfer may occur on the active legacy DMA channels.

Workaround: Software must suspend all legacy DMA channels before suspending an active DMA XOR channel (channel 0 or 1).

Status: For the affected steppings, see the Summary Tables of Changes.

BT93. DWORD-Aligned DMA XOR Descriptors With Fencing and Multi-Channel Operation May Cause a Channel Hang

Problem: DMA XOR descriptors with DWORD aligned sources and fencing enabled may result in a XOR channel hang until the next platform reset. XOR DMA fencing is set by software in Descriptor Control.Fence (XOR base descriptor, bit 4)

Implication: An XOR DMA descriptor with non cacheline aligned sources may hang until the next platform reset.

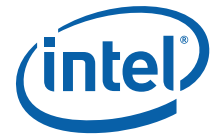

Workaround: Do not enable fencing on XOR descriptors. Fencing can be enabled on legacy descriptors. It is recommended that a NULL legacy descriptor must be paired with each XOR descriptor. Software can use fencing of the legacy NULL descriptor to track full completion of its associated XOR descriptor.

Status: For the affected steppings, see the Summary Tables of Changes.

BT94. Erratum Removed

BT95. Processor May not Restore the VR12 DDR3 Voltage Regulator Phases upon Pkg C3 State Exit

Problem: During the Pkg (Package) C3 state entry, the processor directs the VR12 DDR3 voltage regulators to shed phases to reduce power consumption. Due to this erratum, the processor may not restore all VR12 DDR3 voltage regulator phases upon Pkg C3 state exit. The VR12 DDR3 voltage regulators require all phases to keep the DDR3 voltage plane in tolerance for proper memory subsystem functioning during normal system operation.

Implication: Due to this erratum, unpredictable system behavior may occur.

Workaround: It is possible for the BIOS to contain a workaround for this erratum.

Status: For the affected steppings, see the Summary Tables of Changes.

BT96. Intel QPI Link Layer Does Not Drop Unsupported or Undefined Packets

Problem: The Intel QPI should detect an unsupported or undefined packet, drop the offending packet, and log a correctable error with an IA32_MCI_STATUS.MCACOD of 0000_1100_0000_1111. When the Intel QPI detects an unsupported or undefined packet it does not drop the offending packet but it does log the error.

Implication: Due to this erratum, Intel QPI does not drop unsupported packets. Intel has not observed any functional failure on commercially available systems due to this erratum.

Workaround: None identified

Status: For the affected steppings, see the Summary Tables of Changes.

BT97. The Equalization Phase Successful Bits Are Not Compliant to the PCIe* Specification

Problem: PCIe Specification states that if the Phase 1 of Transmitter Equalization completes successfully as indicated by the LNKSTS2.Equalization Phase 1 Successful (Devices 0-3; Functions 0-3; bit[2]) bit being set to one and if the Phase 2 and 3 link training phases are bypassed, the LNKSTS2.Equalization Phase 3 Successful (Devices 0-3; Functions 0-3; bit[4]) and LNKSTS2.Equalization Phase 2 Successful (bit[3]) bits should be set to one. Due to this erratum, the processor will only set the Equalization Phase 2 or 3 Successful bits if the phases are completed successfully.

Implication: Due to this erratum, Equalization Phase 2 and 3 Successful bits may not be set. Intel has not observed any functional failure with commercially available PCIe devices.

Workaround: None identified.

Status: For the affected steppings, see the Summary Tables of Changes.

BT98. The Intel® Virtualization Technology for Directed I/O (Intel® VT-d) Queued Invalidation Status Write May Fail

Problem: Intel® Virtualization Technology for Directed I/O (Intel® VT-d) queued invalidation operations issue a status write to modify a semaphore. Due to this erratum, the status write may fail.

Implication: When using queued invalidation operations, a failed status write can result in unpredictable system behavior.

Workaround: If operating without queued invalidations, interrupt re-mapping, and X2APIC features is feasible, then Intel VT-d invalidations should be performed using the Intel VT-d register

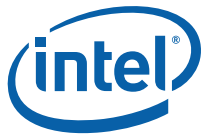

facility (c.f., VTD0_CTXCMD [offset 028h], VTD1_CTXCMD [offset 1028h], VTD0_INVADDRREG [offset 0200h] and VTD0_IOTLBINV [offset 0208h], VTD1_INVADDRREG [offset 1200h] and VTD1_IOTLBINV [offset 1208h] in the Intel VT-d register region with a base address specified through the VTBAR register at 0:5:0, offset 0180h).

If those operational limitations are not feasible, disable Intel VT-d through BIOS facilities. This will prevent the use of Intel VT-d, including X2APIC and Intel TXT facilities that are dependent on Intel VT-d.

Status: For the affected steppings, see the Summary Tables of Changes.

BT99. FP Data Operand Pointer May Be Incorrectly Calculated After an FP Access Which Wraps a 64-Kbyte Boundary in 16-Bit Code

Problem: The FP (Floating Point) Data Operand Pointer is the effective address of the operand associated with the last non-control FP instruction executed by the processor. If an 80-bit FP access (load or store) occurs in a 16-bit mode other than protected mode (in which case the access will produce a segment limit violation), the memory access wraps a 64-Kbyte boundary, and the FP environment is subsequently saved, the value contained in the FP Data Operand Pointer may be incorrect.

Implication: Due to this erratum, the FP Data Operand Pointer may be incorrect. Wrapping an 80-bit FP load around a segment boundary in this way is not a normal programming practice. Intel has not observed this erratum with any commercially available software.

Workaround: If the FP Data Operand Pointer is used in an operating system which may run 16-bit FP code, care must be taken to ensure that no 80-bit FP accesses are wrapped around a 64-Kbyte boundary.

BT100. Executing The GETSEC Instruction While Throttling May Result in a Processor Hang

Problem: If the processor throttles, due to either high temperature thermal conditions or due to an explicit operating system throttling request (TT1), while executing GETSEC[SENTER] or GETSEC[SEXIT] instructions, then under certain circumstances, the processor may hang. Intel has not been observed this erratum with any commercially available software.

Implication: Possible hang during execution of GETSEC instruction.

Workaround: None identified.

Status: For the affected steppings, see the Summary Tables of Changes.

BT101. Incorrect Address Computed for Last Byte of FXSAVE/FXRSTOR or XSAVE/XRSTOR Image Leads to Partial Memory Update

Problem: A partial memory state save of the FXSAVE or XSAVE image or a partial memory state restore of the FXRSTOR or XRSTOR image may occur if a memory address exceeds the 64 KB limit while the processor is operating in 16-bit mode or if a memory address exceeds the 4 GB limit while the processor is operating in 32-bit mode.

Implication: FXSAVE/FXRSTOR or XSAVE/XRSTOR will incur a #GP fault due to the memory limit violation as expected but the memory state may be only partially saved or restored.

Workaround: Software should avoid memory accesses that wrap around the respective 16-bit and 32-bit mode memory limits.

Status: For the affected steppings, see the Summary Tables of Changes.

BT102. FP Data Operand Pointer May be Incorrectly Calculated After an FP Access Which Wraps a 4-Gbyte Boundary in Code That Uses 32-bit Address Size in 64-bit Mode

Problem: The FP (Floating Point) Data Operand Pointer is the effective address of the operand associated with the last non-control FP instruction executed by the processor. If an 80-bit FP access (load or store) uses a 32-bit address size in 64-bit mode and the memory

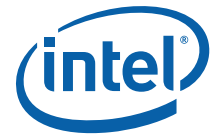

access wraps a 4-Gbyte boundary and the FP environment is subsequently saved, the value contained in the FP Data Operand Pointer may be incorrect.

Implication: Due to this erratum, the FP Data Operand Pointer may be incorrect. Wrapping an 80-bit FP load around a 4-Gbyte boundary in this way is not a normal programming practice. Intel has not observed this erratum with any commercially available software.

Workaround: If the FP Data Operand Pointer is used in a 64-bit operating system which may run code accessing 32-bit addresses, care must be taken to ensure that no 80-bit FP accesses are wrapped around a 4-Gbyte boundary.

Status: For the affected steppings, see the Summary Tables of Changes.

BT103. Execution of VAESIMC or VAESKEYGENASSIST With An Illegal Value for VEX.vvvv May Produce a #NM Exception

Problem: The VAESIMC and VAESKEYGENASSIST instructions should produce a #UD (Invalid-Opcode) exception if the value of the vvvv field in the VEX prefix is not 1111b. Due to this erratum, if CR0.TS is "1", the processor may instead produce a #NM (Device-Not-Available) exception.

Implication: Due to this erratum, some undefined instruction encodings may produce a #NM instead of a #UD exception.

Workaround: Software should always set the vvvv field of the VEX prefix to 1111b for instances of the VAESIMC and VAESKEYGENASSIST instructions.

Status: For the affected steppings, see the Summary Tables of Changes.

BT104. Removed Duplicate Erratum

BT105. LBR May Contain Incorrect Information When Using FREEZE_LBRS_ON_PMI

Problem: When FREEZE_LBRS_ON_PMI is enabled (bit 11 of IA32_DEBUGCTL MSR (1D9H) is set), and a taken branch retires at the same time that a PMI (Performance Monitor Interrupt) occurs, then under certain internal conditions the record at the top of the LBR stack may contain an incorrect "From" address.

Implication: When the LBRs are enabled with FREEZE_LBRS_ON_PMI, the "From" address at the top of the LBR stack may be incorrect.

Workaround: It is possible for the BIOS to contain a workaround for this erratum.

Status: For the affected steppings, see the Summary Tables of Changes.

BT106. Performance Monitoring May Overcount Some Events During Debugging

Problem: If the debug-control register (DR7) is configured so that some but not all of the breakpoints in the debug-address registers (DR0-DR3) are enabled and one or more of the following performance-monitoring counters are locally enabled (via IA32_CR_PERMON_EVNTSEL_CNTR{3:0}):

```
BR_INST_RETIRED
BR_MISP_RETIRED
FP_ASSIST
FP_ASSIST
INST_RETIRED
MACHINE_CLEARS
MEM_LOAD_UOPS_LLC_HIT_RETIRED
MEM_LOAD_UOPS_MISC_RETIRED.LLC_MISS
MEM_LOAD_UOPS_RETIREDMEM_TRANS_RETIREDMEM_UOPS_RETIRED
OTHER_ASSISTS
ROB_MISC_EVENTS.LBR_INSERTS
UOPS_RETIRED
```



Any of the globally enabled (via IA32_CR_EMON_PERF_GLOBAL_CTRL) counters may overcount certain events when a disabled breakpoint condition is met.

Implication: Performance-monitor counters may indicate a number greater than the number of events that occurred.

Workaround: Software can disable all breakpoints by clearing DR7. Alternatively, software can ensure that, for a breakpoint disabled in DR7, the corresponding debug-address register contains an address that prevents the breakpoint condition from being met (for example, a non-canonical address).

Status: For the affected steppings, see the Summary Tables of Changes.

BT107. HDRLOG Registers do not Report the Header for PCIe* Port 1 Packets with Detected Errors

Problem: The HDRLOG registers contain the header information of the first PCIe packet detected that contains errors. Because of this erratum, the Port 1 (IOU2) HDRLOG registers (CPUBUS(0), Device 1, Function 0; Offsets 164H, 168H, 16CH, 170H) do not reflect the header of a packet with a detected error.

Implication: The HDRLOG registers cannot be used to debug the receipt of packets with detected errors on Port 1.

Workaround: None identified.

Status: For the affected steppings, see the Summary Tables of Changes.

BT108. PECI Temperature Data Values Returned During Reset May be Non-Zero

Problem: The processor PECI power-up time line presented in the *Intel® Xeon® Processor E5-1600/E5-2600/E5-4600 Product Families Datasheet - Volume One* or *Intel® Xeon® E5-2400 Product Family Datasheet- Volume Two* defines the value returned by the PECI GetTemp() command as 0x0000 - the maximum value - during the 'Data Not Ready' (DNR) phase (starting approximately 100 μS after PWRGOOD assertion and lasting until approximately 500 μS after RESET de-assertion). Due to this erratum, the GetTemp() command returns a small negative number during the DNR phase.

Implication: The temperature reported during the PECI DNR phase may be below the maximum and therefore may not have the intended effect of causing platform fans to operate at full speed until the actual processor temperature becomes available.

Workaround: Processor thermal management solutions utilizing PECI should operate platform fans at full speed during the PECI DNR phase.

Status: For the affected steppings, see the Summary Tables of Changes.

BT109. TSOD Related SMBus Transactions May not Complete When Package C-States are Enabled

Problem: The processor may not complete SMBus (System Management Bus) transactions targeting the TSOD (Temperature Sensor On DIMM) when Package C-States are enabled. Due to this erratum, if the processor transitions into a Package C-State while an SMBus transaction with the TSOD is in process, the processor will suspend receipt of the transaction. The transaction completes while the processor is in a Package C-State. Upon exiting Package C-State, the processor will attempt to resume the SMBus transaction, detect a protocol violation, and log an error.

Implication: When Package C-States are enabled, the SMBus communication error rate between the processor and the TSOD may be higher than expected.

Workaround: It is possible for the BIOS to contain a workaround for this erratum.

Status: For the affected steppings, see the Summary Tables of Changes.

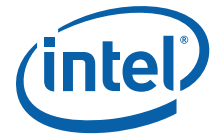

BT110. Erratum Removed

BT111. DRAM RAPL Dynamic Range is too Narrow on the Low Side

Problem: The lower limit for the DRAM RAPL (Running Average Power Limit) dynamic range is specified to be about 120% of DRAM minimum power. Due to this erratum, the lower limit is enforced at about 170% of DRAM minimum power. DRAM minimum power can be found in the Minimal DRAM Power field (DRAM_POWER_INFO CSR at CPUBUS(1), Device 10, Function 2, Offset 90H; bits[30:16]).

Implication: DRAM RAPL cannot regulate DRAM power consumption to as low a level as expected.

Workaround: It is possible for the BIOS to contain a workaround for this erratum.

Status: For the affected steppings, see the Summary Tables of Changes.

BT112. MCACOD 0119H Reported in IA32_MC3_Status is Ambiguous

Problem: The Machine Check Error Code (MCACOD) in the IA32_MC3_STATUS (MSR 040DH) register is intended to report the type of error that has been discovered. The 0119H MCACOD is correctly logged for MLC (Mid-Level Cache) generic read errors and, due to this erratum, also logged for errors detected as a result of MONITOR instructions.

Implication: It may not be possible to distinguish the precise operation associated with an MLC machine check error.

Workaround: It is possible for the BIOS to contain a workaround for this erratum.

Status: For the affected steppings, see the Summary Tables of Changes.

BT113. The Processor Incorrectly Transitions from Polling.Active to Polling.Compliance After Receiving Two TS1 Ordered Sets with the Compliance Bit Set

Problem: The processor PCIe* interface incorrectly transitions from the Polling.Active Link state to the Polling.Compliance Link state after receiving two TS1 Ordered Sets with the Compliance Bit set instead of the eight TS1 Ordered Sets required by the specification.

Implication: It is possible that the PCIe link may enter Polling.Compliance Link state unexpectedly. Exposure to this erratum requires bit errors on the Compliance Receive bit (Byte 5, Bit 4) on sequential TS1 ordered sets.

Workaround: None identified.

Status: For the affected steppings, see the Summary Tables of Changes.

BT114. Patrol Scrubbing May Not Resume Properly After Package C3 and Package C6 States

Problem: Patrol scrubbing is disabled at entry into Package C3 and Package C6 states. Due to this erratum, the memory subsystem may not get fully scrubbed in the expected 24-hour timeframe.

Implication: Memory may not be scrubbed as expected when patrol scrubbing is enabled while Package C3 and/or Package C6 states are enabled. As a consequence, single bit memory errors may not be proactively corrected and could increase the likelihood of uncorrectable memory errors.

Workaround: It is possible for the BIOS to contain a workaround for this erratum.

Status: For the affected steppings, see the Summary Tables of Changes.

BT115. Shallow Self-Refresh Mode is Used During S3

Problem: The processor should be instructing DRAM to utilize deep self-refresh at entry into the S3 state. Due to this erratum, the processor is instructing the DRAM to use shallow self-refresh upon entry into the S3 state.

Implication: The power dissipation of the DRAMs will be greater than expected during S3 state.



Workaround: It is possible for the BIOS to contain a workaround for this erratum.

Status: For the affected steppings, see the Summary Tables of Changes.

BT116. Platform Idle Power May be Higher Than Expected

Problem: The processor may not place the associated DRAM subsystem in the lowest allowed power state during Package C3 and Package C6 states. This may cause the platform idle power to be higher than expected.

Implication: Platform average power and idle power may be higher than expected.

Workaround: It is possible for the BIOS to contain a workaround for this erratum.

Status: For the affected steppings, see the Summary Tables of Changes.

BT117. PECI Transactions during an S-State Transition May Result in a Platform Cold Reset

Problem: Due to this erratum, a PECI transaction during an S-state transition may result in an unexpected platform cold reset rather than an S-state transition.

Implication: Use of PECI transactions during an S-state transition can result in a platform reset that terminates transitioning to the desired S-state.

Workaround: It is possible for the BIOS to contain a workaround for this erratum.

Status: For the affected steppings, see the Summary Tables of Changes.

BT118. Complex Platform Conditions during a Transition to S4 or S5 State May Result in an Internal Timeout Error

Problem: Due to this erratum, the BIOS sequencing associated with S4 (sometimes known as "Hibernate") and S5 (also known as "Soft Off"), when undertaken with certain complex platform conditions, can result in an internal timeout error as indicated by IA32_MCI_STATUS.MCACOD of 0000_0100_0000_0000 and IERR assertion. This internal timeout error stops the platform S-state sequencing before platform power down occurs. Certain platforms may have logic that, upon detection of the failure to reach power down, initiates a cold reset sequence.

Implication: S4 state or S5 state may not be reliably entered; the platform may not reach the very low power condition.

Workaround: It is possible for the BIOS to contain a workaround for this erratum.

Status: For the affected steppings, see the Summary Tables of Changes.

BT119. Writes to SDOORBELL or B2BDOORBELL in Conjunction With Inbound Access to NTB MMIO Space May Hang System

Problem: A posted write targeting the SDOORBELL (Offset 64H) or B2BDOORBELL (Offset 140H) MMIO registers in the region defined by Base Address Register PB01BASE (Bus 0; Device 3; Function 0; Offset 10H) or SB01BASE (Bus M; Device 0; Function 0; Offset 10H) may hang the system. This system hang may occur if the NTB (Non-Transparent Bridge) is processing a transaction from the secondary side of the NTB that is targeting the NTB shared MMIO registers or targeting the secondary side configuration registers when the write arrives.

Implication: The system may hang if the processor writes to the local SDOORBELL or B2BDOORBELL register at the same time that the NTB is processing an inbound transaction.

Workaround: In NTB/NTB (back-to-back) mode, do not use the B2BDOORBELL to send interrupts from the local to remote host. Instead, configure one of the following local register pairs to point to the remote SB01BASE region:

- PB23BASE (Device: 3; Function: 0; Offset: 18H) and PBAR2XLAT (Offset 10H) from PB01BASE or SB01BASE regions;
- PB45BASE (Device: 3; Function: 0; Offset: 20H) and PBAR4XLAT (Offset 18H) from PB01BASE, or SB01BASE regions;

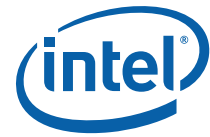

The local host may then write directly to the PDOORBELL (Offset 60H) from the PB23BASE/PB45BASE region defined above.

In NTB/RP (bridge to root port) mode, the SDOORBELL register cannot be used by the processor on the primary side of the NTB to interrupt the processor on the secondary side. Instead, dedicate a BAR and XLAT pair, either PB23BASE/PBAR2XLAT or PB45BASE/PBAR4XLAT, to generate an interrupt directed directly into the MSI/MSIx (Message Signaled Interrupt) interrupt range on the remote processor. The device driver or client on the remote host must point the appropriate PBARnXLAT register to its MSI/MSIx interrupt range. The processor on the primary side can then write the MSI/MSIx interrupt to the dedicated BAR which will be translated by the NTB to the MSI/MSIx region of the secondary side's processor.

Status: For the affected steppings, see the Summary Tables of Changes.

BT120. Programming PDIR And an Additional Precise PerfMon Event May Cause Unexpected PMI or PEBS Events

Problem: PDIR (Precise Distribution for Instructions Retired) mechanism is activated by programming INST_RETIRED.ALL (event COH, umask value 00H) on Counter 1. When PDIR is activated in PEBS (Precise Event Based Sampling) mode with an additional precise PerfMon event, an incorrect PMI or PEBS event may occur.

Implication: Due to this erratum, when another PEBS event is programmed along with PDIR, an incorrect PMI or PEBS event may occur.

Workaround: Software should not program another PEBS event in conjunction with the PDIR mechanism.

Status: For the affected steppings, see the Summary Tables of Changes.

BT121. A Peci RdIAMSr Command Near IERR Assertion May Cause the Peci Interface to Become Unresponsive

Problem: When a Peci RdIAMSr command is issued to the processor near the time that the processor is experiencing an internal timeout error, as indicated by IA32_MCi_STATUS.MCACOD of 0000_0100_0000_0000 and IERR assertion, the Peci interface may issue an 81H (timeout) response. After a timeout response, the processor will ignore future Peci commands until it is reset.

Implication: Due to this erratum, Peci commands typically used to debug a processor that is not behaving normally - RdPkgConfig and RdPciConfig - may not be available after an internal timeout error.

Workaround: It is possible for the BIOS to contain a workaround for this erratum.

Status: For the affected steppings, see the Summary Tables of Changes.

BT122. Long Latency Transactions May Cause I/O Devices on the Same Link to Time Out

Problem: Certain long latency transactions - for example, master aborts on inbound traffic, locked transactions, peer-to-peer transactions, or vendor defined messages - conveyed over the PCIe* and DMI2 interfaces can block the progress of subsequent transactions for extended periods. In certain cases, these delays may lead to I/O device timeout that can result in device error reports and/or device off-lining.

Implication: Due to this erratum, devices that generate PCIe or DMI2 traffic characterized by long latencies can interfere with other traffic types on the same link. This may result in reduced I/O performance and device timeout errors. USB traffic can be particularly sensitive to these delays.

Workaround: Avoid the contributing conditions. This can be accomplished by separating traffic types to be conveyed on different links and/or reducing or eliminating long latency transactions.

Status: For the affected steppings, see the Summary Tables of Changes.



BT123. The Coherent Interface Error Codes "C2", "C3", "DA" and "DB" are Incorrectly Flagged

Problem: The Coherent Interface Error Status Registers (IRPP0ERRST and IRPP1ERRST at CPUBUS(0), Device 5, Function 2, Offsets 230H and 2B0H respectively) indicate that an error has been detected by the Coherent Interface.

Bit 3 indicates that a Write Cache Un-correctable ECC (C2) error has occurred.
Bit 4 indicates that a CSR access crossing 32-bit boundary (C3) error has occurred.
Bit 13 indicates that a Protocol Queue/Table Overflow or Underflow (DA) error has occurred.
Bit 14 indicates that a Protocol Parity Error (DB) error has occurred.

Due to this erratum, the processor may incorrectly log the "C2", "C3", "DA" and "DB" error flags.

Implication: The "C2", "C3", "DA" and "DB" error flags are indeterminate.

Workaround: Mask off the "C2", "C3", "DA" and "DB" error flags (bit 3, bit 4, bit 13 and bit 14) of the IRPP0ERRCTL and IRPP1ERRCTL registers at CPUBUS(0), Device 5, Function 2, Offsets 234H and 2B4H respectively.

Status: For the affected steppings, see the Summary Tables of Changes.

BT124. If Multiple Poison Events Are Detected within Two Core Clocks, the Overflow Flag May not be Set

Problem: If multiple poison events are detected within two core clocks, the error is logged with an IA32_MCI_STATUS.MCACOD of 0000_0001_0011_0100 but the IA32_MCI_STATUS.OVER (bit [60]) may not be set.

Implication: Due to this erratum, only one poison event may be reported by a logical processor when more than one poison event was encountered.

Workaround: None identified.

Status: For the affected steppings, see the Summary Tables of Changes.

BT125. PCI Express* Capability Structure Not Fully Implemented

Problem: According to the PCIe* Base Specification, "The PCI Express Capability structure is required for all PCI Express device functions." Due to this erratum, some PCI Express Capabilities Fields were not implemented ("Device Capability," "Device Status" and "Device Control") for CPUBUS[0], Device 5, Function 2, reads to these fields will return zero.

Implication: Software that depends on the PCI Express Capability Structure fields Device Capability, Device Status and/or Device Control will not operate properly.

Workaround: None identified.

Status: For the affected steppings, see the Summary Tables of Changes.

BT126. The PCIe* Receiver Lanes Surge Protection Circuit May Intermittently Cause a False Receive Detection on Some PCIe Devices

Problem: The processor implements a surge protection circuit on the PCIe receiver lanes. Due to this erratum, during platform power-on some PCIe devices may trigger the surge protection circuit causing a false receive detect. If this unexpected detection occurs before the processor's PCIe lane termination impedances are enabled and the resulting PCIe device link training enters the link training Polling.Active state, the PCIe device may incorrectly transition into the Polling.Compliance state.

Implication: After platform power-on, some PCIe devices may not exit from the compliance state causing the link to fail to train or the link may train to a degraded width.

Workaround: A BIOS change has been identified and may be implemented as a workaround for this erratum.

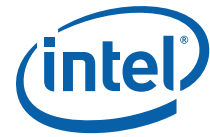

Status: For the affected steppings, see the Summary Tables of Changes.

BT127. Software Reads From LMMIOH_LIMIT Register May be Incorrect

Problem: The MMIOH is a memory-mapped I/O region relocatable above 4 GB. Due to this erratum, software reads of the LMMIOH_LIMIT register (Local MMIO High Base, Device: 5, Function: 0, Offset 118H) may yield incorrect results, although software writes to this register function as expected.

Implication: Software depending on LMMIOH_LIMIT register reads may not behave as expected. Intel has not identified any commercially available software that is affected by the erratum.

Workaround: None identified.

Status: For the affected steppings, see the Summary Tables of Changes.

BT128. Patrol Scrub is Incompatible with Rank Sparing on More than One Channel

Problem: The iMC (Integrated Memory Controller) permits independent sparing of one rank on each memory channel. Due to this erratum, Patrol Scrub operation is impaired when more than one ranking sparing event occurs.

Implication: If more than one channel has undergone a rank sparing event, Patrol Scrub may scrub ranks that should have been taken out of service and may skip scrubbing ranks that are in service. In the former case, excessive errors will be reported while in the latter case, memory is incompletely scrubbed.

Workaround: Patrol Scrub should not be enabled when more than one channel has suffered a rank sparing event. This can be accomplished during the BIOS initialization phase by either

- Not enabling the Patrol Scrub feature
- Not enabling the rank sparing feature.

Alternatively, during run time one of the following can be implemented

- Patrol Scrub can be disabled when the second rank sparing event occurs
- Disallowing any rank sparing event after the first one

Please refer to the latest version of the BIOS Specification Update and release notes.

Status: For the affected steppings, see the Summary Tables of Changes.

BT129. Multi-Socket Intel® TXT Platform May Enter a Sequence of Warm Resets

Problem: Due to this erratum, a platform warm reset issued while a processor is attempting an authenticated boot on a multi-socket Intel® Trusted Execution Technology (Intel® TXT) platform may initiate a series of repeating warm resets.

Implication: A warm reset attempt during an authenticated boot on a multi-socket Intel TXT platform may lead to platform unavailability.

Workaround: It is possible for the BIOS to contain a workaround for this erratum.

Status: For the affected steppings, see the Summary Tables of Changes.

BT130. NTB May Incorrectly Set MSI or MSI-X Interrupt Pending Bits

Problem: The NTB (Non-transparent Bridge) may incorrectly set MSI (Message Signaled Interrupt) pending bits in MSIPENDING (BAR PB01BASE,SB01BASE; Offset 74H) while operating in MSI-X mode or set MSI-X pending bits in PMSIXPBA (BAR PB01BASE, SB01BASE; Offset 03000H) while operating in MSI mode.

Implication: Due to this erratum, NTB incorrectly sets MSI or MSI-X pending bits. The correct pending bits are also set and it is safe to ignore the incorrectly set bits.



Workaround: None Identified.

Status: For the affected steppings, see the Summary Tables of Changes.

BT131. DWORD Aligned XOR DMA Sources May Prevent Further DMA XOR Progress

Problem: XOR DMA channels may stop further progress in the presence of Locks/PHOLDS if the source pointed to by a DMA XOR descriptor is not cacheline aligned.

Implication: Non-cacheline aligned DMA XOR sources may hang both channels 0 and 1. A reset is required in order to recover from the hang. Legacy DMA descriptors on any channel have no source alignment restrictions.

Workaround: Software must either:

- Ensure XOR DMA descriptors only point to cache-line aligned sources (best performance) OR
- A legacy DMA copy must be used prior to non-cacheline aligned DMA operations to guarantee that the source mis-alignment is on DWORD15 of the cacheline. The required source that must be misaligned to DWORD15, depends on the following desired subsequent DMA XOR operations:
 - DMA XOR Validate (RAID5/ P-Only): The P-source must be mis-aligned to DWORD15 (last DWORD).
 - DMA XOR Validate (RAID6/P+Q): The Q-source must be mis-aligned to DWORD15 (last DWORD).
 - DMA XOR Generate or Update: The last source (which will be different based on numblk) must be misaligned to DWORD15 (last DWORD).

Status: For the affected steppings, see the Summary Tables of Changes.

BT132. Using I/O Peer-to-Peer Write Traffic Across an NTB May Lead to a Hang

Problem: If two systems are connected via an NTB (Non-Transparent Bridge), either the internal NTB or an external NTB, and both systems attempt to send I/O peer-to-peer write traffic across the NTB either to memory or an I/O device on the remote system, it is possible for both systems to deadlock.

Implication: Due to this erratum, using I/O peer-to-peer write traffic across an NTB may lead to a hang.

Workaround: A BIOS code change has been identified and may be implemented as a workaround for this erratum.

Status: For the affected steppings, see the Summary Tables of Changes.

BT133. Unable to Clear Received PME_TO_ACK in NTB

Problem: When the NTB (Non-transparent Bridge) is enabled, the Received PME_TO_ACK bit in MISCCTRLSTS (Device 3; Function 0; Offset 188H; Bit[48]) can not be cleared if the timeout for receiving PME_TO_ACK is enabled (Device 3; Function 0; Offset 188H, Bit[5] is 0).

Implication: Due to this erratum, software may be unable to clear Received PME_TO_ACK.

Workaround: None identified.

Status: For the affected steppings, see the Summary Tables of Changes.

BT134. NTB Does Not Set PME_TO_ACK After a PME_TURN_OFF Request

Problem: The NTB (Non-transparent Bridge) does not set PME_TO_ACK in MISCCTRLSTS (Device 3; Function 0: Offset 188H; Bit [48]) after a PME_TURN_OFF request.

Implication: Due to this erratum, the NTB will not acknowledge a PME_TURN_OFF request.



Workaround: ACPI or other software must have a time-out to proceed with the power management event and should not wait indefinitely for the NTB to acknowledge the PME_TURN_OFF request.

Status: For the affected steppings, see the Summary Tables of Changes.

BT135. PCMPESTRI, PCMPESTRM, VPCMPESTRI and VPCMPESTRM Always Operate with 32-bit Length Registers

Problem: In 64-bit mode, using REX.W=1 with PCMPESTRI and PCMPESTRM or VEX.W=1 with VPCMPESTRI and VPCMPESTRM should support a 64-bit length operation with RAX/RDX. Due to this erratum, the length registers are incorrectly interpreted as 32-bit values.

Implication: Due to this erratum, using REX.W=1 with PCMPESTRI and PCMPESTRM as well as VEX.W=1 with VPCMPESTRI and VPCMPESTRM do not result in promotion to 64-bit length registers.

Workaround: It is possible for the BIOS to contain a workaround for this erratum.

Status: For the affected steppings, see the Summary Tables of Changes.

BT136. PECI Commands Differing Only in Length Field May be Interpreted as Command Retries

Problem: Due to this erratum, the processor interprets any PECI read or write command that accesses the processor, a downstream PCI device, or package configuration space and differs from the preceding request only in the length field as a retry request. That is, a retry will be inferred by the processor even if the read length and write length fields don't match between two consecutive requests, regardless of the state of the host retry bit on the succeeding request.

Implication: Back-to-back PECI commands that are identical with the exception of the length field may yield incorrect results if processor retry completion codes are ignored by the PECI host.

Workaround: PECI hosts should retry timed-out commands until they complete successfully by reissuing a PECI command sequence identical to the originally timed-out command.

Status: For the affected steppings, see the Summary Tables of Changes.

BT137. Performance Monitor Precise Instruction Retired Event May Present Wrong Indications

Problem: When the PDIR (Precise Distribution for Instructions Retired) mechanism is activated (INST_RETIRE.ALL (event C0H, umask value 00H) on Counter 1 programmed in PEBS mode), the processor may return wrong PEBS/PMI interrupts and/or incorrect counter values if the counter is reset with a SAV below 100 (Sample-After-Value is the counter reset value software programs in MSR IA32_PMC1[47:0] in order to control interrupt frequency).

Implication: Due to this erratum, when using low SAV values, the program may get incorrect PEBS or PMI interrupts and/or an invalid counter state.

Workaround: The sampling driver should avoid using SAV<100.

Status: For the affected steppings, see the Summary Tables of Changes.

BT138. VM Exits from Real-Address Mode Due to Machine Check Exceptions May Incorrectly Save RFLAGS.RF as 1

Problem: If a machine check is encountered while fetching an instruction, and if the resulting machine check exception causes a VM exit, the VM exit should save an RFLAGS value in the guest-state area of the VMCS with the RF value that existed at the time of the machine check. Due to this erratum, such VM exits that occur in real-address mode may save RFLAGS.RF as 1 even if it had been 0.



Implication: The processor may fail to report an instruction breakpoint following a return to real-address mode via VM entry.

Workaround: It is possible for the BIOS to contain a workaround for this erratum.

Status: For the affected steppings, see the Summary Tables of Changes.

BT139. The Integrated Memory Controller Does Not Enforce CKE High for tXSDLL DCLKs After Self-Refresh

Problem: The JEDEC STANDARD DDR3 SDRAM Specification (No. 79-3E) requires that the CKE signal be held high for tXSDLL DCLKs after exiting self-refresh before issuing commands that require a locked DLL (Delay-Locked Loop). Due to this erratum, the Integrated Memory Controller may not meet this requirement with 512 Mb, 1 Gb, and 2Gb devices in single rank per channel configurations.

Implication: Violating tXSDLL may result in DIMM clocking issues and may lead to unpredictable system behavior.

Workaround: A BIOS code change has been identified and may be implemented as a workaround for this erratum.

Status: For the affected steppings, see the Summary Tables of Changes.

BT140. The Default Value of the I/O Base Address Field Does Not Comply with the PCI-to-PCI Bridge Architecture Specification

Problem: The PCI-to-PCI Bridge Architecture Specification defines the default value of the I/O Base Address Field (IOBAS CPUBUS(0); Device 0-3; Function 0-3; Offset 1Ch; bits [3:2]) to 0. Due to this erratum, the processor's default value is 3.

Implication: It is possible that system software will generate an error due to this erratum.

Workaround: A BIOS code change has been identified and may be implemented as a workaround for this erratum.

Status: For the affected steppings, see the Summary Tables of Changes.

BT141. A Sustained Series of PCIe* Posted Upstream Writes Can Lead to Deadlock

Problem: Due to this erratum, a sustained series of PCIe posted upstream writes to the same cache line, with no other access of that same cache line, may cause a deadlock.

Implication: Under a complex set of conditions, a sustained series of PCIe posted upstream writes targeting the same cache line can lead to deadlock. Intel has not been observed this erratum with any commercially available system.

Workaround: It is possible for the BIOS to contain a workaround for this erratum.

Status: For the affected steppings, see the Summary Tables of Changes.

BT142. Extraneous Characters are Included in the Processor Brand String

Problem: The Processor Brand String is provided by the CPUID instruction for leaf values EAX=80000002H, 80000003H, and 80000004H. Each execution of the three CPUID leaf value returns 16 ASCII bytes of the Processor Brand String in the EAX, EBX, ECX, and EDX registers. Due to this erratum, an extra zero character ("0", 30H ASCII code) and space character (" ", 20H ASCII code) are inserted after the processor number in the brand string output. In the following example brand string, the extraneous characters are underlined: "Intel® Xeon® CPU E5-2680 0 @ 2.70 GHz".

Implication: An extraneous "0" and "space" character are included in the Processor Brand String.

Workaround: The extraneous characters may be ignored or removed by software.

Status: For the affected steppings, see the Summary Tables of Changes.



BT143. IMC Controlled Dynamic DRAM Refresh Rate Can Lead to Unpredictable System Behavior

Problem: DRAMs require a 2x refresh rate when operating above 85°C. Due to this erratum, the IMC (Integrated Memory Controller) logic intended to double the refresh rate when DRAM temperature exceeds 85°C can cause DRAM access failures, leading to unpredictable system behavior.

Implication: The IMC is not able to dynamically adjust the DRAM refresh rate based on DRAM temperature. If DRAMs may be operated above 85°C then BIOS must configure the IMC for a doubled refresh rate.

Workaround: A BIOS code change has been identified and may be implemented as a workaround for this erratum.

Status: For the affected steppings, see the Summary Tables of Changes.

BT144. Incorrect Error Address Status May Get Logged

Problem: When a correctable Machine Check event with a valid address precedes an uncorrectable Machine Check event without a valid address, the IA32_MCi_STATUS OVER flag (bit 62) should be set and ADDR_V flag (bit 58) should be cleared. Due to this erratum, both flags may be set.

Implication: The Machine Check report logged may incorrectly indicate valid address information when the OVER flag is set.

Workaround: It is possible for the BIOS to contain a workaround for this erratum.

Status: For the affected steppings, see the Summary Tables of Changes.

BT145. The Machine Check Threshold-Based Error Status Indication May be Incorrect

Problem: A corrected cache hierarchy data or tag error is reported in IA32_MCi_STATUS.MCACOD (bits [15:0]) with value of 000x_0001_xxxx_xx01 (where x stands for zero or one). An error status indication (bits [54:53]) value of 10B indicates that the corrected error count has exceeded the yellow threshold. Due to this erratum, subsequent corrections after the yellow indication has been set may change the error status indication to green (bits [54:53] equal to 00B).

Implication: The threshold-based error status indication is unreliable.

Workaround: It is possible for the BIOS to contain a workaround for this erratum.

Status: For the affected steppings, see the Summary Tables of Changes.

BT146. IA32_MCi_STATUS Registers May Contain Undefined Data After Reset

Problem: Due to this erratum, if the RESET_N signal is asserted while the processor is in a Package C State the IA32_MCi_STATUS registers may contain undefined data after the processor completes the reset. In particular, the IA32_MCi_STATUS.VAL (bit[63]) may be set incorrectly indicating a valid Machine Check has been logged.

Implication: Invalid errors may be reported in the IA32_MCi_STATUS registers.

Workaround: It is possible for the BIOS to contain a workaround for this erratum.

Status: For the affected steppings, see the Summary Tables of Changes.

BT147. Refresh Cycles for High Capacity DIMMs Are Not Staggered

Problem: Certain high capacity DIMMs, typically Quad Rank RDIMMs and LR-DIMMs, may exceed instantaneous and short-term power limits if refresh cycles are not correctly staggered. Due to this erratum, the Integrated Memory Controller is unable to stagger refresh cycles.

Implication: Some DIMMs may exceed power limits during refresh operations leading to unpredictable system behavior.

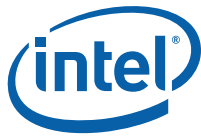

Workaround: It is possible for the BIOS to contain a workaround for this erratum.

Status: For the affected steppings, see the Summary Tables of Changes.

BT148. A Stream of Snoops Can Lead to a System Hang or Machine Check

Problem: Due to this erratum, a stream of snoop requests to a single cache slice may cause the processor in that slice to livelock, resulting in a system hang or Internal Timer Error machine check indicated by IA32_MCI_STATUS.MCACOD (bits 15:0, 0000 0100 0000 0000).

Implication: A system hang or machine check may occur. Intel has not observed this erratum with any commercially available software.

Workaround: It is possible for the BIOS to contain a workaround for this erratum.

Status: For the affected steppings, see the Summary Tables of Changes.

BT149. IA32_MCI_STATUS.EN May Not be Set During Certain Machine Check Exceptions

Problem: Due to this erratum, IA32_MCI_STATUS.EN may not be set as expected after the MLC (Mid-Level Cache) has logged a fatal error with a MCACOD value of 000X_0001_XXXX_XX10 (where X stands for zero or one) and signaled an MCE (Machine Check Error) as a result of encountering poisoned data.

Implication: The value of IA32_MCI_STATUS.EN may be inconsistent with signaling an MCE while logging a fatal error, however a machine check exception is still signaled.

Workaround: It is possible for the BIOS to contain a workaround for this erratum.

Status: For the affected steppings, see the Summary Tables of Changes.

BT150. Intel QPI Link Physical Layer error results in MCERR during warm reset

Problem: A warm reset is defined as a reset that does not involve the shutdown of the power to the system (that is, only RESET_N is asserted while PWRGOOD remains asserted). Due to this erratum, during warm reset the processor may incorrectly apply common-mode voltage correction on the Intel QPI interface, resulting in a link training failure.

Implication: The system may hang when a warm reset is attempted.

Workaround: A BIOS code change has been identified and may be implemented as a workaround for this erratum.

Status: For the affected steppings, see the Summary Tables of Changes.

BT151. LLC Cache Correctable Errors Are Not Counted And Logged

Problem: LLC Cache correctable errors are logged in the Corrected_Error_Count field bits [53:38] of the IA32_MC[19:12]_STATUS MSR. Due to this erratum, LLC Cache corrections are not counted and logged.

Implication: Software using the corrected error count may not function correctly. A CMCI (corrected machine check error interrupt) may not be generated when the error threshold programmed in IA32_CR_MC[19:12]_CTL2.ERROR_THRESHOLD (bits [14:0]) would otherwise be expected to be met.

Workaround: It is possible for the BIOS to contain a workaround for this erratum.

Status: For the affected steppings, see the Summary Tables of Changes.

BT152. The Processor Incorrectly Transitions From The PCIe* Recovery.RcvrLock LTSSM State to the Configuration.Linkwidth.Start LTSSM State

Problem: When a PCIe link is operating at 2.5 GT/s and the processor's LTSSM (Link Training and Status State Machine) is in Recovery.RcvrLock state, the processor expects to receive TS1 ordered sets within 24 ms. If it does not receive the TS1s in the allotted time, the



LTSSM should transition to the Detect state. Due to this erratum, if the processor does not receive TS1s within 24 ms, it will transition to Configuration.LinkWidth.Start. In that state, if it receives no TS1s, it will transition to Detect. If it receives TS1s, it will configure the link appropriately and return to L0.

Implication: The state transition sequence from the Recovery.RcvrLock LTSSM state to the Configuration.Linkwidth.Start LTSSM state is in violation of the PCIe Specification. Intel has not observed any functional failures due to this erratum with any commercially available PCIe devices.

Workaround: None identified.

Status: For the affected steppings, see the Summary Tables of Changes.

BT153. Writes to B2BSPAD[15:0] Registers May Transfer Corrupt Data Between NTB Connected Systems

Problem: Writes to the NTB (Non-Transparent Bridge) B2BSPAD[15:0] registers (BAR PB01BASE, SB01BASE; Offsets 100H - 13FH) may result in corrupted data transfer between systems.

Implication: Using B2BSPAD[15:0] registers to transfer data may not work as expected.

Workaround: Do not use the B2BSPAD[15:0] to send data from the local to remote host. Instead, configure one of the following local register pairs to point to the remote SB01BASE region:

- PB23BASE (Device 3; Function 0; Offset 18H) and PBAR2XLAT (Offset 10H) from PB01BASE or SB01BASE regions;
- PB45BASE (Device 3; Function 0; Offset 20H) and PBAR4XLAT(Offset 18H) from PB01BASE, or SB01BASE regions;

The local host may then write directly to the SPAD[15:0] registers (Offsets 80H - 0BFH) of the remote system from the PB23BASE/PB45BASE region defined above.

Status: For the affected steppings, see the Summary Tables of Changes.

BT154. Erratum Removed

BT155. Excessive DRAM RAPL Power Throttling May Lead to a System Hang or USB Device Off-Lining

Problem: DRAM RAPL (Running Average Power Limit) is a facility for limiting the maximum power consumption of the memory subsystem. DRAM RAPL's control mechanism constrains the number of memory transactions during a particular time period. Due to this erratum, a very low power limit can throttle certain memory subsystem configurations to an extent that system failure, ranging from permanent loss of USB devices to system hangs, may result.

Implication: Using DRAM RAPL to regulate the memory subsystem power to a very low level may cause platform instability.

Workaround: It is possible for the BIOS to contain processor configuration data and code changes as a workaround for this erratum.

Status: For the affected steppings, see the Summary Tables of Changes.

BT156. NTB Operating In NTB/RP Mode With MSI/MSI-X Interrupts May Cause System Hang

Problem: The NTB (Non-transparent Bridge) operating in NTB/RP (NTB to Root Port mode) using Message Signaled Interrupts (MSI or MSI-X) in the presence of locks may result in a system hang.

Implication: Due to this erratum, system may hang under the condition described above.

Workaround: A BIOS code change has been identified and may be implemented as a workaround for this erratum.



Status: For the affected steppings, see the Summary Tables of Changes.

BT157. XSAVEOPT May Fail to Save Some State after Transitions Into or Out of STM

Problem: The XSAVEOPT instruction may optimize performance by not saving state that has not been modified since the last execution of XRSTOR. This optimization should occur only if the executions of XSAVEOPT and XRSTOR are either both or neither in SMM (system-management mode). Due to this erratum, this optimization may be performed by the first execution of XSAVEOPT after a transition into or out of the STM (SMM-transfer monitor) if the most recent execution of XRSTOR occurred before that transition. For transitions into the STM, the erratum applies only to transitions using the VMCALL instruction. This erratum can occur only if the two executions are at the same privilege level, use the same linear address, and are either both or neither in VMX non-root operation. The erratum does not apply if software in SMM never uses XRSTOR or XSAVEOPT.

Implication: This erratum may lead to unpredictable system behavior.

Workaround: STM software should execute the XRSTOR instruction with the value 0 in EDX:EAX after each transition into the STM (after setting CR4.OSXSAVE) and before each transition out of the STM. Bytes 512 to 575 of the save area used by XRSTOR should be allocated in memory, but bytes 0 to 511 need not be. Bytes 512 to 535 should all be 0.

Status: For the affected steppings, see the Summary Tables of Changes.

BT158. Rank Sparing May Cause an Extended System Stall

Problem: The Integrated Memory Controller sequencing during a rank sparing copy operation blocks all writes to the memory region associated with the rank being taken out of service. Due to this erratum, this block can result in a system stall that persists until the sparing copy operation completes.

Implication: The system can stall at unpredictable times which may be observed as one time instance of system unavailability.

Workaround: A BIOS code change has been identified and may be implemented as a workaround for this erratum.

Status: For the affected steppings, see the Summary Tables of Changes.

BT159. System Hang May Occur when Memory Sparing is Enabled

Problem: Due to this erratum, enabling memory sparing can result in an internal timer error as indicated by the IA32_MCI_STATUS.MCACOD of 0000_0100_0000_0000.

Implication: Enabling memory sparing may result in a system may hang.

Workaround: It is possible for the BIOS to contain a workaround for this erratum.

Status: For the affected steppings, see the Summary Tables of Changes.

BT160. Enabling Opportunistic Self-Refresh and Pkg C2 State Can Severely Degrade PCIe* Bandwidth

Problem: Due to this erratum, enabling opportunistic self-refresh can lead to the memory controller over-aggressively transitioning DRAM to self-refresh mode when the processor is in Pkg C2 state.

Implication: The PCIe interface peak bandwidth can be degraded by as much as 90%.

Workaround: A BIOS code change has been identified and may be implemented as a workaround for this erratum.

Status: For the affected steppings, see the Summary Tables of Changes.

BT161. Mirrored Memory Writes May Lead to System Failures

Problem: In mirrored memory mode, each channel manages its memory write bandwidth resources. Due to this erratum, if a channel in mirrored memory mode is heavily



utilized, it is possible for issued writes to exceed available bandwidth resulting in write failures.

Implication: A system hang or unpredictable system behavior may occur.

Workaround: A BIOS code change has been identified and may be implemented as a workaround for this erratum.

Status: For the affected steppings, see the Summary Tables of Changes.

BT162. End Agent PCIe Packet Errors May Result in a System Hang

Problem: PCIe agents are required by the PCIe Base Specification to identify and report packet errors. Due to this erratum, certain invalid completion types from the end agent are not correctly handled by the processor.

Implication: If a PCIe end agent issues certain invalid completion types, the system may hang.

Workaround: None identified.

Status: For the affected steppings, see the Summary Tables of Changes.

BT163. Retraining Cannot be Initiated by Downstream Devices in NTB/NTB or NTB/RP Configurations

Problem: The PCIe Base Specification requires that a downstream device can initiate link retraining. Due to this erratum, link retraining cannot be initiated by the downstream device in a NTB/NTB (Non-Transparent Bridge) or a NTB/RP (Root Port) configuration.

Implication: The Retrain_Link field (LNKCON Device 3; Function 0; Offset 1A0H; bit [5]) does not function as expected in the identified configurations; software referencing the downstream device is not able to retrain the link.

Workaround: The link speed and training must be managed by the upstream host in NTB/NTB or NTB/RP configurations.

Status: For the affected steppings, see the Summary Tables of Changes.

BT164. PCIe Port in NTB Mode Flags Upstream Slot Power Limit Message as UR

Problem: When the processor is in NTB (Non-Transparent Bridge) mode, it should ignore upstream Slot Power Limit messages from the root port it is connected to. Due to this erratum, the processor generates UR (Unsupported Request) on these Slot Power Limit messages when in NTB mode.

Implication: Due to this erratum, some messages will be improperly flagged with UR.

Workaround: Upstream Slot Power Limit Message should be disabled in the identified configurations.

Status: For the affected steppings, see the Summary Tables of Changes.

BT165. Spurious SMIs May Occur Due to MEMHOT# Assertion

Problem: The IMC (Integrated Memory Controller) can be programmed to generate an SMI (System Management Interrupt) on an internal MEMHOT# event assertion through the MHOT_SMI_EN field (MH_MAINCNTL Bus: 1; Device: 15; Function: 0; Offset: 104H; bit[17]) or on assertion of the external MEMHOT[1:0]#pin through the MHOT_EXT_SMI_EN field (MH_MAINCNTL Bus: 1; Device: 15; Function: 0; Offset: 104H; bit[18]). Due to this erratum, a spurious SMI may be generated every 500uS if both internal and external MEMHOT events are enabled simultaneously.

Implication: Due to this erratum, excessive SMI generation may occur.

Workaround: A BIOS code change has been identified and may be implemented as a workaround for this erratum.

Status: For the affected steppings, see the Summary Tables of Changes.



BT166. PCIe Link Bandwidth Notification Capability is Incorrect

Problem: A value of 1 in the Link_Bandwidth_Notification_Capability field (LKNCAP bit 21) for a PCIe device indicates support for the Link Bandwidth Notification status and interrupt mechanisms. Due to this erratum, this field for ports 2c, 2d, 3c and 3d (LKNCAP Bus 0; Device 2,3; Function 2,3; Offset 09Ch; bit 21) always reads as 0 when it should read as 1.

Implication: Software that reads this field for the listed ports will incorrectly conclude that the Link Bandwidth Notification status and interrupt mechanisms are not available.

Workaround: Software should ignore the value of the Link_Bandwidth_Notification_Capability field for ports 2c, 2d, 3c, and 3d.

Status: For the affected steppings, see the Summary Tables of Changes.

BT167. Port 3a Capability_Pointer Field is Incorrect When Configured in PCIe Mode

Problem: The Capability_Pointer field (CAPPTR Bus 0; Device 3; Function 0; Offset 34H; bits [7:0]) should have its value based on the configured mode of the port, PCIe or NTB (Non-Transparent Bridge). Due to this erratum, this field reports the NTB value (60H) when in PCIe mode instead of the PCIe value (40H).

Implication: Software depending on the value of this field may not behave as expected.

Workaround: A BIOS code change has been identified and may be implemented as a workaround for this erratum.

Status: For the affected steppings, see the Summary Tables of Changes.

BT168. Uncorrectable Intel QPI Errors May Cause the System to Power Down

Problem: Due to this erratum, under a complex set of conditions, Intel QPI uncorrectable errors may cause a deadlock between the processor and PCH (Platform Controller Hub). The deadlock will cause a processor internal timeout error as indicated by IA32_MCI_STATUS.MCACOD of 0000_0100_0000_0000, CATERR# assertion and a Shutdown transaction being sent to the PCH. Depending on the platform implementation, this will result in reset being asserted to the PCH. This deadlock persists, causing the PCH to timeout on the reset request. Reacting to the reset request timeout, the PCH powers down the system.

Implication: The system will be powered down and the IA32_MCI_Status register contents will be lost. The system may need to be manually powered back on. Intel has not observed this erratum in the absence of injected uncorrectable Intel QPI errors.

Workaround: A BIOS code change has been identified and may be implemented as a workaround for this erratum. This is a partial workaround that causes the system to power cycle, eliminating the need for manual power on. The IA32_MCI_Status register contents are still lost.

Status: For the affected steppings, see the Summary Tables of Changes.

BT169. Four Outstanding PCIe Configuration Retries May Cause Deadlock

Problem: PCIe configuration retries are allowed for older generation PCI/PCI-X bridges that take a long time to respond to configuration cycles after a reset. Due to this erratum, a fifth configuration cycle following the fourth PCIe configuration retry may not make progress, resulting in a deadlock.

Implication: A deadlock could occur. Intel has not observed this erratum with any commercially available system.

Workaround: When configuring devices on PCI/PCI-X buses, BIOS should wait for configuration cycles to complete before issuing subsequent configuration cycles.

Status: For the affected steppings, see the Summary Tables of Changes.

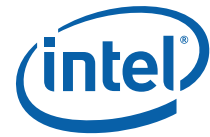

BT170. A PECI RdPciConfigLocal Command Referencing a Non-Existent Device May Return an Unexpected Value

Problem: Configuration reads to non-existent PCI configuration registers should return 0FFFF_FFFFH. Due to this erratum, when the PECI RdPciConfigLocal command references a non-existent PCI configuration register, the value 0000_0000H may be returned instead of the expected 0FFFF_FFFFH.

Implication: A PECI RdPciConfigLocal command referencing a non-existent device may observe a return value of 0000_0000H. Software expecting a return value of 0FFFF_FFFFH to identify non-existent devices may not work as expected.

Workaround: Software that performs enumeration via the PECI "RdPciConfigLocal" command should interpret 0FFFF_FFFFH and 0000_0000H values for the Vendor Identification and Device Identification Register as indicating a non-existent device.

Status: For the affected steppings, see the Summary Tables of Changes.

BT171. Some PCIe CCR Values Are Incorrect

Problem: The CCR (Class Code Register) value for the following devices should be 088000H instead is 000000H:

- Bus 0; Device 6; Function 1-7; Offset 09H; bits [23:0]
- Bus 0; Device 7; Function 0-4; Offset 09H; bits [23:0]

Implication: Due to this erratum, the CCR base and sub-class status of the listed PCIe devices is incorrectly reported and may cause software to conclude that these devices are host bridges and are not general system peripherals.

Workaround: A BIOS code change has been identified and may be implemented as a workaround for this erratum.

Status: For the affected steppings, see the Summary Tables of Changes.

BT172. When in DMI Mode, Port 0's Device_Port_Type Field is Incorrect

Problem: When in DMI mode, the Device_Port_Type field (PXPCAP Bus 0; Device 0; Function 0; Offset 92H; bits [7:4]) should read as 9H (DMI mode) but incorrectly reads as 4H (PCIe* mode).

Implication: Software may incorrectly conclude that this port is operating in PCIe mode when it is actually being used in the DMI mode.

Workaround: None identified.

Status: For the affected steppings, see the Summary Tables of Changes.

BT173. PCIe TPH Attributes May Result in Unpredictable System Behavior

Problem: TPH (Transactions Processing Hints) are optional aids to optimize internal processing of PCIe transactions. Due to this erratum, certain transactions with TPH attributes may be misdirected, resulting in unpredictable system behavior.

Implication: Use of the TPH feature may affect system stability.

Workaround: A BIOS code change has been identified and may be implemented as a workaround for this erratum.

Status: For the affected steppings, see the Summary Tables of Changes.

BT174. Continuous Intel QPI Retraining Feature Indication is Incorrect

Problem: The processor is capable of continuous Intel QPI retraining. Due to this erratum, the field reporting support for this feature "Continuous Retraining" (QPIREUT_PH_CPR Bus 1; Device 8,9; Function 3; Offset 128H; bit 18) indicates this feature is not supported although it is enabled and cannot be disabled.

Implication: Due to this erratum, it is not possible to disable the continuous Intel QPI retraining feature.



Workaround: None identified.

Status: For the affected steppings, see the Summary Tables of Changes.

BT175. Correctable Memory Errors May Result in Unpredictable System Behavior

Problem: Under certain conditions, the processor may not detect or correct a correctable memory error.

Implication: When this erratum occurs, it may result in unpredictable system behavior.

Workaround: A BIOS code change has been identified and may be implemented as a workaround for this erratum.

Status: For the affected steppings, see the Summary Tables of Changes.

BT176. Not an Erratum

BT177. Not an Erratum

BT178. IA32_MCi_STATUS ADDR_V Bit May be Incorrectly Cleared

Problem: The IA32_MCi_STATUS MSR's ADDR_V bit (bit 58) is set upon logging an error in order to indicate that the contents of the IA32_MCi_ADDR MSR is valid. Due to this erratum, a cancelled speculative load of poisoned data spanning a cacheline boundary can clear the ADDR_V flag associated with a previously logged error report.

Implication: The clearing of the ADDR_V flag in IA32_MCi_STATUS when this erratum occurs will result in the loss of the address logged in a correctable error report. It should be noted that a cancelled speculative load of poisoned data that crosses a cacheline boundary is an unusual occurrence.

Workaround: None identified.

Status: For the affected steppings, see the Summary Tables of Changes.

BT179. Intel® QuickData Technology DMA Lock Quiescent Flow Causes DMA State Machine to Hang

Problem: The lock quiescent flow is a means for an agent to gain sole ownership of another agent's resources by preventing other devices from sending transactions. Due to this erratum, during the lock quiescent flow, the Intel QuickData Technology DMA read and write queues are throttled simultaneously. This prevents subsequent read completions from draining into the write queue, hanging the DMA lock state machine.

Implication: The DMA lock state machine may hang during a lock quiescent flow.

Workaround: A BIOS code change has been identified and may be implemented as a workaround for this erratum.

Status: For the affected steppings, see the Summary Tables of Changes.

BT180. Malformed TLP Power Management Messages May Be Dropped

Problem: The PCIe Base Specification requires Power Management Messages to use the default Traffic Class designator, TC0, and receivers to check for violations of this rule. Due to this erratum, a TLP using a non-default Traffic Class designator will be dropped, rather than handled as a Malformed TLP.

Implication: An Advanced Error Reporting ERR_FATAL notification will not be logged for Malformed TLP Power Management Messages.

Workaround: None identified

Status: For the affected steppings, see the Summary Tables of Changes.



BT181. Core Frequencies at or Below the DRAM DDR Frequency May Result in Unpredictable System Behavior

Problem: The Intel SpeedStep® Technology can dynamically adjust the core operating frequency to as low as 1200 MHz. Due to this erratum, under complex conditions and when the cores are operating at or below the DRAM DDR frequency, unpredictable system behavior may result.

Implication: Systems using Intel SpeedStep Technology with DDR3-1333 or DDR3-1600 memory devices are subject to unpredictable system behavior.

Workaround: It is possible for the BIOS to contain a workaround for this erratum.

Status: For the affected steppings, see the Summary Tables of Changes.

BT182. Quad Rank DIMMs May Not be Properly Refreshed During IBT_OFF Mode

Problem: The Integrated Memory Controller incorporates a power savings mode known as IBT_OFF (Input Buffer Termination disabled). Due to this erratum, Quad Rank DIMMs may not be properly refreshed during IBT_OFF mode.

Implication: Use of IBT_OFF mode with Quad Rank DIMMs may result in unpredictable system behavior.

Workaround: A BIOS code change has been identified and may be implemented as a workaround for this erratum.

Status: For the affected steppings, see the Summary Tables of Changes.

BT183. Intel® QuickData Technology DMA Non-Page-Aligned Next Source/Destination Addresses May Result in Unpredictable System Behavior

Problem: Non-page aligned Intel® QuickData Technology DMA next source/destination addresses may cause memory read-write collisions.

Implication: Due to this erratum, using non-page aligned next source/destination addresses may result in unpredictable system behavior.

Workaround: Next source/destination addresses must be page aligned. The Intel-provided Intel QuickData Technology DMA driver abides by this alignment rule.

Status: For the affected steppings, see the Summary Tables of Changes.

BT184. Enabling Relaxed Ordering With Intel QuickData Technology May Result in a System Hang

Problem: Enabling RO (Relaxed Ordering) for Intel QuickData Technology transactions via the Enable Relaxed Ordering field (DEVCON Device 4; Function 0-7; Offset 98H; bit 4) while inbound RO is disabled for the DMA via the Disable RO field on writes from Intel QuickData DMA (IOMISCCTRL Device 5; Function 0; Offset: 1C0H; bit 22) creates a conflict. The Disable inbound RO for Intel QuickData DMA writes control takes precedence. Due to this erratum, the processor will incorrectly return a strongly ordered completion for the transaction which can then live lock or result in a system hang.

Implication: The processor may live lock resulting in a system hang.

Workaround: A BIOS code change has been identified and may be implemented as a workaround for this erratum.

Status: For the affected steppings, see the Summary Tables of Changes.

BT185. Spurious CRC Errors May be Detected on Intel QPI Links

Problem: The processor autonomously manages Intel QPI (QuickPath Interconnect) Link power state transitions based on link idle intervals. Due to this erratum, CRC errors may be detected during Intel QPI Link power state transitions and may be logged in QPIREUT_ERR_CED (Bus 1; Device 8,9; Function 3; Offset 120H).



Implication: Spurious Intel QPI Link CRC errors may be reported.

Workaround: A BIOS code change has been identified and may be implemented as a workaround for this erratum.

Status: For the affected steppings, see the Summary Tables of Changes.

BT186. PECE Temperature Lower Limit May be as High as 7°C

Problem: PECE reports temperatures as an offset from the PROCHOT threshold (a negative value when the temperature is below the PROCHOT threshold, zero when at or above that threshold). If the temperature is below 0°C, PECE responds with an “Invalid Temperature” encoding (8002H). Due to this erratum, PECE may indicate an invalid temperature when the actual temperature is as high as 7°C.

Implication: An invalid temperature report from PECE indicates the actual temperature is 7°C or lower. Platform facilities depending PECE to provide accurate temperature readings between 0°C and 7°C may not function correctly.

Workaround: None identified.

Status: For the affected steppings, see the Summary Tables of Changes.

BT187. The DRAM Power Meter May Not be Accurate

Problem: The DRAM Power Meter uses VR (Voltage Regulator) current readings in combination with weighted activity counters to provide a running estimate of DRAM subsystem power. Due to this erratum, the DRAM Power Meter may not be sufficiently accurate for system power management purposes.

Implication: The DRAM Power Meter cannot be relied upon to provide accurate DRAM subsystem power measurements. Reduced or variable system performance may be a side effect.

Workaround: It is possible for BIOS to contain a workaround for this erratum.

Status: For the affected steppings, see the Summary Tables of Changes.

BT188. PCIe* Port 3 Link Training May be Unreliable in NTB Mode

Problem: If PCIe port 3 is in NTB (Non-Transparent Bridge) mode and both the Root port and Endpoint Hardware Autonomous Speed Disable fields (LNKCON2 Bus 0; Device 3; Function 0; Offset 0C0H; bit 5) are set to 0, link training may fail. The Recovery.RcvrLock state may intermittently timeout and transition to the Detect state.

Implication: The NTB port link training may be unreliable.

Workaround: A BIOS code change has been identified and may be implemented as a workaround for this erratum.

Status: For the affected steppings, see the Summary Tables of Changes.

BT189. Functionally Benign PCIe* Electrical Specification Violation Compendium

Problem: Violations of PCIe electrical specifications listed in the table below have been observed.

Specification	Violation Description
De-emphasis ratio limit: -3.5±0.5 dB	Ave: -3.8 dB, Min: -4.09 dB
At 5 GT/s operation, the receiver must tolerate AC common mode voltage of 300 mV (Peak-to-Peak) and must tolerate 78.1 ps jitter	Simultaneous worst case AC common mode voltage and worst case jitter during 5 GT/s operation may result in intermittent failures leading to subsequent recovery events
TTX-UPW-TJ (uncorrelated total pulse width jitter) maximum of 24 ps	Samples have measured as high as 25 ps
The Transmitter PLL bandwidth and peaking for PCIe at 5 GT/s is either 8-16 MHz with 3 dB of peaking or 5-16 MHz with 1 dB of peaking	Samples have measured 7.8-16 MHz with 1.3 dB of peaking

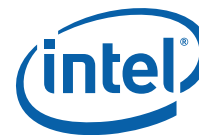

Specification	Violation Description
During the LTSSM Receiver Detect State, common-mode resistance to ground is 40-60 ohms.	Samples have measured up to 100 ohms.
8 GT/s Receiver Stressed Eye	Samples marginally pass or fail the 10^{-12} BER target under stressed eye conditions
8 GT/s PLL Bandwidth: 2 to 4 MHz with 2 dB peaking.	Samples have a measured bandwidth of up to 4.1 MHz

Implication: Intel has not observed failures from the violations listed in this erratum on any commercially available platforms and/or using commercially available PCIe devices.

Workaround: None identified.

Status: For the affected steppings, see the Summary Tables of Changes.

BT190. A Machine Check Exception Due to Instruction Fetch May Be Delivered Before an Instruction Breakpoint

Problem: Debug exceptions due to instruction breakpoints take priority over exceptions resulting from fetching an instruction. Due to this erratum, a machine check exception resulting from the fetch of an instruction may take priority over an instruction breakpoint if the instruction crosses a 32-byte boundary and the second part of the instruction is in a 32-byte poisoned instruction fetch block.

Implication: Instruction breakpoints may not operate as expected in the presence of a poisoned instruction fetch block.

Workaround: None identified.

Status: For the affected steppings, see the Summary Tables of Changes.

BT191. Intel® QPI May Report a Reserved Value in the Link Initialization Status Field During Link Training

Problem: An Intel QPI (QuickPath Interconnect) link reports its Link Training progress in the Intel QPI Link Status register. Due to this erratum, the Link Initialization Status (QPILS Bus 1; Device 8,9; Function 0; Offset 48H; bits [27:24]) incorrectly reports a reserved encoding of 1101b while in the "Initial Credit return (initializing credits)" state. The correct encoding for the "Initial Credit return (initializing credits)" state is 0101b.

Implication: Software that monitors the Link Initialization Status field during Link Training may see a reserved encoding reported.

Workaround: None identified. Software may ignore or re-interpret the incorrect encoding for this processor.

Status: For the affected steppings, see the Summary Tables of Changes.

BT192. Enhanced Intel SpeedStep® Technology May Cause a System Hang

Problem: Enhanced Intel SpeedStep® Technology dynamically changes core operating frequencies. Due to this erratum, under complex conditions, core frequency changes may result in a system hang.

Implication: Enhanced Intel SpeedStep Technology may cause a system hang.

Workaround: It is possible for the BIOS to contain a workaround for this erratum.

Status: For the affected steppings, see the Summary Tables of Changes.

BT193. PROCHOT May Be Incorrectly Asserted at Reset

Problem: The PROCHOT signal is used to indicate elevated processor temperatures during normal operation and is used for FRB (Fault Resilient Boot) actions during the reset sequence. Due to this erratum, the elevated temperature indication usage of PROCHOT can persist into reset and subsequently can cause improper FRB actions.

Implication: Elevated die temperatures at reset time may impair platform operation.



Workaround: It is possible for the BIOS to contain a workaround for this erratum.

Status: For the affected steppings, see the Summary Tables of Changes.

BT194. Package C3-State and Package C6-State Residency is Too Low

Problem: The Intel QPI link must transition to its L1 power state for the processor to enter Package C3-state or Package C6-state. Due to this erratum, the Intel QPI link does not transition to L1 as intended, restricting the processor from reaching Package C3-state or Package C6-state.

Implication: The increased idle state power consumption caused by reduced Package C3-state and Package C6-state residency may exceed the processor idle power specification for multi-socket platforms.

Workaround: It is possible for BIOS to contain a workaround for this erratum.

Status: For the affected steppings, see the Summary Tables of Changes.

BT195. PECI RdPkgConfig() May Return Invalid Data For an Unsupported Channel

Problem: The processor's PECI facility can report the current temperature of each of the DIMMs on a specified channel (PECI RdPkgConfig command, index 14H, DIMM_Temperature_Read). Valid channel numbers range from 0 to 3. Channel numbers outside of the valid range should be detected and flagged. Due to this erratum, meaningless values are returned without an error flag when 4 is specified as the channel number.

Implication: Using channel 4 with the PECI RdPkgConfig DIMM_Temperature_Read command does not return an error flag.

Workaround: None identified.

Status: For the affected steppings, see the Summary Tables of Changes.

BT196. DRAM PBM Overflow May Result in a System Hang

Problem: The DRAM PBM (Power Budget Meter) manages DRAM power consumption. Due to this erratum, under complex platform conditions, the DRAM PBM may throttle the memory subsystem to such a great extent that a system hang results.

Implication: The DRAM PBM may cause platform instability.

Workaround: It is possible for the BIOS to contain a workaround for this erratum.

Status: For the affected steppings, see the Summary Tables of Changes.

BT197. Combining ROL Transactions with Non-ROL Transactions or Marker Skipping Operations May Result In a System Hang

Problem: When Intel® Quick Data Technology DMA ROL (Raid On Load) transactions and non-ROL transactions are simultaneously active, and the non-ROL address offsets are not cacheline boundary aligned, the non-ROL transaction's last partial cacheline data write may be lost leading to a system hang. In addition, when Intel QuickData DMA ROL transactions are active, marker skipping operations may lead to a system hang.

Implication: When this erratum occurs, the processor may live lock resulting in a system hang.

Workaround: None identified. When ROL transactions and non-ROL transactions are simultaneously active, all non-ROL address offsets must be aligned on cacheline boundaries. Further, marker skipping operations may not be used on any DMA channel when ROL transactions are active.

Status: For the affected steppings, see the Summary Tables of Changes.

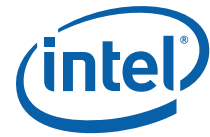

BT198. Error Indication in PCIe Lane Error Status Incorrectly Set When Operating at 8 GT/s

Problem: The Lane Error Status field in bits[15:0] of LNERRSTS (Device 1; Function 0,1; Offset 258H; and Device 2,3; Function 0,1,2,3; Offset 258H) is used to monitor errors on the PCIe lanes. Due to this erratum, the LNERRSTS bits associated with the lanes operating at 8 GT/s port are spuriously set.

Implication: LNERRSTS cannot be used to reliably monitor errors on the PCIe lanes operating at 8 GT/s.

Workaround: A BIOS code change has been identified and may be implemented as a workaround for this erratum.

Status: For the affected steppings, see the Summary Tables of Changes.

BT199. PCIe* Link May Not Train to Full Width

Problem: During PCIe link training, the receiver looks at symbols in the TS1 and TS2 Ordered Sets as indicators of lane polarity inversion. If polarity inversion is detected, the receiver must invert those lane(s). Due to this erratum, the receiver may incorrectly set polarity inversion.

Implication: PCIe links may not train to full width.

Workaround: None identified. Perform a Secondary Bus Reset on the link up to three times to achieve full width.

Status: For the affected steppings, see the Summary Tables of Changes.

BT200. The Minimum Snoop Latency Requirement That Can be Specified is 64 Microseconds

Problem: The PCIE_ILTR_OVRD CSR (Device 10; Function 1; Offset 78H) and SW_LTR_OVRD MSR (0A02H) include fields defined to allow specification of a required maximum snoop latency threshold. That maximum latency is intended to be used by the processor to adjust various operational parameters so that the latency requirement can be met. Due to this erratum, the minimum latency value that can be specified via the Snoop Latency Multiplier field (bits[28:26]) and the Snoop Latency Value field (bits[25:16]) is 64 microseconds.

Implication: A minimum snoop latency requirement of 64 microseconds is so long that these registers are not useful.

Workaround: None identified. BIOS and the OS have other means to specify Package C-state exit latency maximums, which is the typical use model for setting PCIe snoop latency limits.

Status: For the affected steppings, see the Summary Tables of Changes.

BT201. Patrol Scrubbing Doesn't Skip Ranks Disabled After DDR Training

Problem: If a rank is detected as failed after completing DDR training then BIOS will mark it as disabled. Disabled ranks are omitted from the OS memory map. Due to this erratum, a rank disabled after DDR training completes is not skipped by the Patrol Scrubber. Patrol Scrubbing of the disabled ranks may result in superfluous correctable and uncorrectable memory error reports.

Implication: Disabling ranks after DDR training may result in the over-reporting of memory errors.

Workaround: A BIOS code change has been identified and may be implemented as a workaround for this erratum.

Status: For the affected steppings, see the Summary Tables of Changes.

BT202. Simultaneously Enabling Patrol Scrubbing, Package C-States, and Rank Sparing May Cause the Patrol Scrubber to Hang

Problem: Patrol Scrubbing is a RAS facility that scans all physical memory (including any spare ranks) to find errors and attempts to fix single bit errors. Patrol Scrubbing is suspended



when the processor enters a deep Package C-State then resumed when that Package C-state is exited. Due to this erratum, under complex conditions, resuming Patrol Scrubbing from a Package C-State after a rank sparing event may cause the Patrol Scrubber to hang.

Implication: Enabling Package C-States, Rank Sparing, and Patrol Scrubbing simultaneously can lead to a Patrol Scrubber hang.

Workaround: A BIOS code change has been identified and may be implemented as a workaround for this erratum.

Status: For the affected steppings, see the Summary Tables of Changes.

BT203. Patrol Scrubbing Will Report Uncorrectable Memory Errors Found on a Spare Rank

Problem: Due to this erratum, Patrol Scrubbing signals an uncorrectable Machine Check Event when it encounters an uncorrectable error while scrubbing a spare rank. The error logged in IA32_MC{8-11}_STATUS (MSR 421H, 425H, 429H, 42DH) will have the PCC field (bit 57) set to '1' and the ADDR_V field (bit 58) set to '0' (that is, there is no address information associated with the error report).

Implication: An uncorrectable Machine Check Event may occur for physical memory that is not in use at the time of the event.

Workaround: None identified.

Status: For the affected steppings, see the Summary Tables of Changes.

BT204. Patrol Scrubbing During Memory Mirroring May Improperly Signal Uncorrectable Machine Checks

Problem: With memory mirroring enabled, Patrol Scrub detection of an uncorrectable error on one channel of the mirror should be downgraded to a correctable error when valid data is present on the other channel of the mirror. Due to this erratum, Patrol Scrub detection of an uncorrectable error always signals an uncorrectable Machine Check.

Implication: This erratum may cause reduced availability of systems with mirrored memory.

Workaround: It is possible for BIOS to contain processor configuration data and code changes as a workaround for this erratum.

Status: For the affected steppings, see the Summary Tables of Changes.

BT205. Directory Mode and Memory Mirroring are Incompatible with Demand Scrubbing or Mirror Scrubbing

Problem: Directory Mode is a performance feature used on four socket and scalable platforms to reduce average snoop latency. Mirror Scrubbing attempts to erase uncorrectable errors found in one mirror channel by overwriting them with the correct data from the other channel. Due to this erratum, enabling Memory Mirroring and Directory Mode with Demand Scrubbing and/or Mirror Scrubbing can result in unpredictable system behavior. Patrol Scrubbing with Memory Mirroring enabled and Directory Mode enabled is not affected by this erratum.

Implication: Enabling Memory Mirroring and Directory Mode with Demand Scrubbing and/or Mirror Scrubbing can lead to unpredictable system behavior.

Workaround: A BIOS code change has been identified and may be implemented as a workaround for this erratum.

Status: For the affected steppings, see the Summary Tables of Changes.

BT206. Spurious Power Limit Interrupt May Occur at Package C-State Exit

Problem: The processor monitors power consumption and uses that information to limit core operating frequency. Due to this erratum, power consumption may be improperly calculated by the processor during Package C-states. As a result, the processor may incorrectly signal a power limit interrupt.

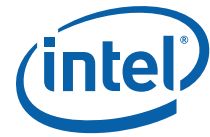

Implication: In response to a power limit interrupt, the OS may choose to operate the processor at its minimum frequency for several milliseconds after the Package C-state exit.

Workaround: None identified. The OS can mask these interrupts by setting the Power Limit Interrupt Enable field (bit 24) in the IA32_THERM_INTERRUPT MSR (19BH) to 0.

Status: For the affected steppings, see the Summary Tables of Changes.

BT207. Intel VT-d Translation Fault May Be Dropped

Problem: Due to this erratum, under complex conditions, an Intel VT-d translation request that results in a DMA Remapping Fault (more commonly called “translation fault”) may be lost.

Implication: An Intel VT-d translation fault might not be properly reported.

Workaround: A BIOS code change has been identified and may be implemented as a workaround for this erratum

Status: For the affected steppings, see the Summary Tables of Changes.

BT208. The Accumulated Energy Status Read Service May Report a Power Spike Early in Boot

Problem: The PECI RdPkgConfig() command with an index value of 03H is the Accumulated Energy Status Read service. During platform boot, the Accumulated Energy Status Read service returns an accumulated energy value of 0. Later in the boot flow, due to this erratum, the Accumulated Energy Status Read service returns a value that is large. Energy values calculated with the first non-zero sample have been observed to be as high as 10kJ over a limited number of parts.

Implication: Software may interpret values returned by the Accumulated Energy Status Read service during boot time as indicating a large power spike. This could lead to unexpected or undesired platform power management actions.

Workaround: Once the first non-zero value is detected, the difference between subsequent sequential values is a reliable measure of energy consumed between the sample points.

Status: For the affected steppings, see the Summary Tables of Changes.

BT209. Certain Uncorrectable Errors May Cause Loss of PECI Functionality

Problem: A PECI completion code of 91H indicates the PCU (Power Control Unit) detected an uncorrectable error that prevented processing of the PECI request. Due to this erratum, certain PCU or VRM error conditions may lead to a persistent 91H completion code for subsequent PECI request. Uncorrectable PCU errors are reported with an IA32_MC4_STATUS.MCACOD (MSR 411H, bits[15:0]) value of 0000_0100_0000_0010, IA32_MC4_STATUS.VALID (bit 63) set to 1, and IA32_MC4_STATUS.UC (bit 61) set to 1.

Implication: PECI processing may be blocked until either a cold reset or software running on one of the cores clears the IA32_MC4_STATUS register.

Workaround: None identified. Software running on one of the cores can clear the IA32_MC4_STATUS register to restore PECI functionality.

Status: For the affected steppings, see the Summary Tables of Changes.

BT210. Machine Check During VM Exit May Result in VMX Abort

Problem: A machine check signaled during VM exit should cause a VMX abort only if the machine check would prevent successful completion of the VM exit; ordinarily, the machine check should be delivered after the VM exit completes. Due to this erratum, certain machine checks (for example, an uncorrectable cache error detected by another logical processor) may force a VM exit to result in a VMX abort even when that machine check does not interfere with the VM exit completing correctly.



Implication: Certain machine checks that could be reported in the host context for orderly logging and analysis may instead induce a VMX abort and shut down the logical processor.

Workaround: It is possible for the BIOS to contain a workaround for this erratum.

Status: For the affected steppings, see the Summary Tables of Changes.

BT211. Address of Poisoned Data Logged in IA32_MCi_ADDR MSR May be Incorrect

Implication: Under certain complex conditions, it is possible for the indication of poisoned data in one cache line to be incorrectly associated with a different cache line. The MCACOD field (IA32_MCi_STATUS MSR, bits[15:0]) value of 000x_0001_xxxx_xx10 indicates poisoned data but the address logged in the IA32_MCi_ADDR MSR may not be that of the poisoned data.

Workaround: Due to this erratum, the address with poisoned data may not be correctly logged in the IA32_MCi_ADDR MSR.

Status: For the affected steppings, see the Summary Tables of Changes.

BT212. Routing Intel® High Definition Audio Traffic Through VC1 May Result in System Hang

Problem: When bit 9 in the IIO_MISC_CTRL CSR (Bus 0; Device 5; Function 0; Offset 1C0H) is set, VCp inbound traffic (Intel® HD Audio) is routed through VC1 to optimize isochronous traffic performance. Due to this erratum, VC1 may not have sufficient bandwidth for all traffic routed through it; overflows may occur.

Implication: This erratum can result in lost completions that may cause a system hang.

Workaround: A BIOS code change has been identified and may be implemented as a workaround for this erratum.

Status: For the affected steppings, see the Summary Tables of Changes.

BT213. Intel® QuickData Technology DMA Suspend Does Not Transition From ARMED to HALT State

Problem: Suspending an Intel QuickData Technology DMA channel while in the ARMED state should transition the channel to the HALT state. Due to this erratum, suspending a DMA channel while in the ARMED state does not change the state to HALT and will cause the DMA engine, when subsequently activated, to ignore the first descriptor's fence control bit and may cause the DMA engine to prematurely discard the first descriptor during the copy stage.

Implication: Suspending a DMA channel while in the ARMED state will cause the DMA engine to ignore descriptor fencing, possibly issue completion status without actually completing all descriptors, and may be subject to unexpected activation of DMA transfers.

Workaround: Check the DMA_trans_state (CHANSTS_0; Bus 0; MMIO BAR: CB_BAR [0:7]; Offset 88H; bits[2:0]) to ensure the channel state is either IDLE (001b) or ACTIVE (000b) before setting Susp_DMA (CHANCMD; Bus 0; MMIO BAR: CB_BAR [0:7]; Offset 84H; bit 2).

Status: For the affected steppings, see the Summary Tables of Changes.

BT214. Package_Energy_Counter Register May Incorrectly Report Power Consumed by The Execution of Intel® Advanced Vector Extensions (Intel® AVX) Instructions

Problem: The processor includes a Package_Energy_Counter register to provide real-time energy consumption information. This facility can be accessed by the PECCI RdPkgConfig() command with an index value of 03H (the Accumulated Energy Status Read service), by reading the PKG_ENERGY_STATUS MSR (611H) or by reading PACKAGE_ENERGY_STATUS CSR (Bus 1; Device 10; Function 0; Offset 90H). Due to this erratum, the power consumption reported during the execution of Intel® Advanced Vector Extensions (Intel® AVX) instructions is inaccurate.



Implication: Software that uses the Package_Energy_Counter register value during the execution of Intel AVX instructions may not behave as expected, possibly compromising thermal load balancing, processor throttling, or other platform management operations.

Workaround: It is possible for the BIOS to contain a workaround for this erratum.

Status: For the affected steppings, see the Summary Tables of Changes.

BT215. Suspending/Resetting a DMA XOR Channel May Cause an Incorrect Data Transfer on Other Active Channels

Problem: Suspending an active DMA XOR channel by setting CHANCMD.Suspend DMA bit (Offset 84; Bit 2) while XOR type DMA channels are active may cause incorrect data transfer on the other active legacy channels. This erratum may also occur while resetting an active DMA XOR channel CHANCMD.Reset DMA bit (Offset 84; Bit 5). CHANCMD is in the region described by CB_BAR (Bus 0; Device 4; function 0-7; Offset 10H).

Implication: Due to this erratum, an incorrect data transfer may occur on the active legacy DMA channels.

Workaround: Software must suspend all legacy DMA channels before suspending an active DMA XOR channel (channel 0 or 1).

Status: For the affected steppings, see the Summary Tables of Changes.

BT216. Intel QPI Power Management May Lead to Unpredictable System Behavior

Problem: Intel QPI protocol includes a mechanism allowing a link in L0 state to dynamically adjust its electrical characteristics for optimal data transmission quality. Due to this erratum, Intel QPI links may remain in L0p or L1 state long enough to prevent dynamic adjustment, making the link unreliable.

Implication: Long-term idle or low utilization Intel QPI links can cause system instability.

Workaround: It is possible for the BIOS to contain a workaround for this erratum.

Status: For the affected steppings, see the Summary Tables of Changes.

BT217. Intel® QPI L0s Exit May Cause an Uncorrectable Machine Check

Problem: Intel QPI links can transition to a lower power state, L0s, to reduce power consumption during transmitter idle periods. Due to this erratum, when an Intel QPI link exits L0s state, the resulting retraining may not be successful.

Implication: Due to this erratum, an uncorrectable error signaled with IA32_MCi_STATUS.MCACOD value of 0000_1110_0000_1111 and IA32_MCi_STATUS.MSCOD[5:0] value of 00_0000 may occur when an Intel QPI link exits from L0s state.

Workaround: A BIOS code change has been identified and may be implemented as a workaround for this erratum.

Status: For the affected steppings, see the Summary Tables of Changes.

BT218. Coherent Interface Write Cache May Report False Correctable ECC Errors During Cold Reset

Problem: The Integrated I/O's coherent interface write cache includes ECC logic to detect errors. Due to this erratum, the write cache can report false ECC errors. This error is signaled by asserting bit 1 (Write Cache Corrected ECC) in the IRPP0ERRST CSR (Bus 0; Device 5; Function 2; Offset 230H) or the IRPP1ERRST CSR (Bus 0; Device 5; Function 2; Offset 2B0H).

Implication: If the coherent interface write cache ECC is enabled, the processor may incorrectly indicate correctable ECC errors in the write cache.

Workaround: A BIOS code change has been identified and may be implemented as a workaround for this erratum.

Status: For the affected steppings, see the Summary Tables of Changes.



BT219. Intel QuickData Technology Continues to Issue Requests After Detecting 64-bit Addressing Errors

Problem: Intel QuickData Technology utilizes the lower 48 address bits of a 64-bit address field. Detection of accesses to source address, destination address, descriptor address, chain address, or completion address outside of this 48-bit range are flagged as “64-bit addressing errors” and should halt DMA processing. Due to this erratum, the Intel QuickData DMA continues to issue requests after detecting certain 64-bit addressing errors involving RAID operations. The failing condition occurs for 64-bit addressing errors in either a Channel Completion Upper Address Register (CHANCMP_0, CHANCMP_1) (Bus 0; MMIO BAR CB_BAR [0:7]; Offset 98H, 9CH), or in the source or destination addresses of a RAID descriptor.

Implication: Programming out of range DMA address values may result in unpredictable system behavior.

Workaround: Ensure all RAID descriptors, CHANCMP_0, and CHANCMP_1 addresses are within the 48-bit range before starting the DMA engine.

Status: For the affected steppings, see the Summary Tables of Changes.

BT220. Encountering Poison Data while Memory Mirroring is Enabled May Cause an Invalid Machine Check

Problem: Memory mirroring is a RAS feature which may allow the memory subsystem to survive an uncorrectable memory error. Due to this erratum, under a complex set of conditions, when mirroring and poisoning are both enabled and poison is encountered on one mirror channel, an invalid uncorrectable machine check may occur along with the expected corrected error. They will be reported as an uncorrectable Cache Hierarchy Error, IA32_MCi_Status with MCACOD = 0000_0001_0011_0100 and MSCOD = 0000_0000_0001_0000, along with a corrected Memory Controller Error, IA32_MCi_Status with MCACOD = 0000_0000_1010_cccc and MSCOD[2] = 1 in combination with IA32_MCi_Misc[32] = 1.

Implication: Due to this erratum, a spurious uncorrectable machine check may occur.

Workaround: A BIOS code change has been identified and may be implemented as a workaround for this erratum.

Status: For the affected steppings, see the Summary Tables of Changes.

BT221. PCIe* RO May Result in a System Hang or Unpredictable System Behavior

Problem: PCIe RO (Relaxed Ordering) is not supported on this processor. Due to this erratum, enabling RO or, equivalently, not disabling RO throughout the Integrated I/O logic may lead to unpredictable system behavior or a system hang.

Implication: Enabling RO for any port or channel may lead to system instability.

Workaround: A BIOS code change has been identified and may be implemented as a workaround for this erratum.

Status: For the affected steppings, see the Summary Tables of Changes.

BT222. Intel VT-d Invalidation Time-Out Error May Not be Signaled

Problem: Intel VT-d (Intel Virtualization Technology for Directed I/O) utilizes ITags to identify ATS (Address Translation Services) invalidation requests for invalidating Device-TLBs on endpoint devices. When an ATS invalidation response time-out is detected, the corresponding ITag is freed and an Invalidation Time-out Error is signaled through the VT-d Fault Status register. Due to this erratum, an ATS invalidation response timeout is detected and reported only for the first outstanding ITag entry.

Implication: As a result of the erratum, the ATS invalidation response timeout condition may not be reliably reported when multiple invalidation requests are outstanding. Intel has not observed this erratum with any commercially available software.



Workaround: None identified.

Status: For the affected steppings, see the Summary Tables of Changes.

BT223. Spurious Machine Check Errors May Occur

Problem: The IA32_MCi_CTL MSR comprises enable bits for various machine check events. When a particular machine check event occurs but the associated bit in IA32_MCi_CTL MSR is not set, the error is not signaled but is logged with the EN flag (bit 60 in IA32_MCi_STATUS MSR) set to zero. Further, the logged error report is not protected from being overwritten by succeeding machine check events (whether those events have the associated IA32_MCi_CTL bit set or cleared). Due to this erratum, it is possible that a UCR (Uncorrectable Recoverable) error with the associated bit in IA32_MCi_CTL MSR set will only set the OVER flag (IA32_MCi_STATUS MSR bit 62) rather than correctly overwriting the entire previously logged error when that previously logged error does not have IA32_MCi_STATUS.EN set.

Implication: The Machine Check Handler may interpret the failed overwrite as a spurious error.

Workaround: None identified

Status: For the affected steppings, see the Summary Tables of Changes.

BT224. Enhanced Intel SpeedStep® Technology Hardware Coordination Cannot be Disabled

Problem: The processor should permit hardware coordination of Enhanced Intel SpeedStep Technology requests to be disabled (then use the most recent P-state request from any core or logical processor to set the processor-wide P-state target). Due to this erratum, the Enhanced Intel SpeedStep Technology Hardware Coordination Disable value in bit 0 of the MISC_PWR_MGMT MSR (1AAH) is ignored; hardware coordination is always enabled.

Implication: It is not possible to prevent hardware P-state coordination.

Workaround: None identified.

Status: For the affected steppings, see the Summary Tables of Changes.

BT225. PCIe Link Upconfigure Capability is Incorrectly Advertised as Supported

Problem: The processor does not allow PCIe devices to dynamically change link width but, due to this erratum, the PCIe Link Upconfigure Capability bit is incorrectly advertised as supported.

Implication: When a downstream device attempts to dynamically change the link's width, the link may not correctly retrain, resulting in an incorrect link width, reversed lane numbers, or Surprise Link Down (SLD).

Workaround: It is possible for BIOS to contain a workaround for this erratum.

Status: For the affected steppings, see the Summary Tables of Changes.

BT226. The IA32_MCi_MISC.HaDbBank Field Should be Ignored

Problem: The IA32_MCi_MISC.HaDbBank Field Should be Ignored

Implication: When analyzing Machine Check Register Bank contents, the IA32_MCi_MISC.HaDbBank field should be ignored.

Workaround: None identified

Status: For the affected steppings, see the Summary Tables of Changes.

BT227. When a PCIe x4 Port Detects a Logical Lane 0 Failure, the Link Will Advertise Incorrect Lane Numbers

Problem: The PCIe interface incorporates a recovery mechanism for link degradation by retraining the link without affecting pending transactions. When a x4 port detects a



lane failure on logical lane 0, the link degrades from x4 to x2 and lane reversal occurs. Due to this erratum, after degrading to x2 and reversing the lanes, the link will incorrectly advertise lane numbers as "PAD 0 1 0" instead of the correct "PAD PAD 1 0".

Implication: Devices that have the ability to negotiate a link with logical lane 0 on a mid physical lane may fail to successfully train the link.

Workaround: None identified.

Status: For the affected steppings, see the Summary Tables of Changes.

BT228. Certain PCIe* TLPs May be Dropped

Problem: A PCIe TLP (Transaction Layer Packet) header can specify the request alignment (via byte enables), include TPH (Transaction Processing Hints), and request address translation via the AT field. Due to this erratum, a TLP with non-zero byte enables (i.e., not DWORD-aligned) that includes a non-zero TPH and with an AT field of "01" may be dropped.

Implication: Under the conditions noted, a PCIe TLP may be dropped, causing unpredictable system behavior. Intel has not observed this erratum with any commercially available software.

Workaround: Platforms must ensure that TPH and address translation requests are not used in the same TLP. The most direct means is to disable TPH in a PCIe device that may request an address translation. This can be accomplished by ensuring that TPH Requester Control Register (at offset 08H in the device's TPH Requester Capability structure) bits [9:8] are zero.

Status: For the affected steppings, see the Summary Tables of Changes.

BT229. A Machine Check Exception Concurrent With an I/O SMI May Be Erroneously Reported as Re-startable

Problem: A machine check exception that is delivered between the execution of an I/O instruction (IN, INS, OUT, or OUTS) and an SMI (system-management interrupt) triggered by that instruction may prevent proper handling of the SMI; because of this, the machine check exception should not be reported as restartable. Due to this erratum, such a machine check exception may be reported as restartable.

Implication: A restartable machine check exception on an I/O instruction concurrent with a resulting SMI may result in unpredictable system behavior.

Workaround: It is possible for the BIOS to contain a workaround for this erratum.

Status: For the affected steppings, see the Summary Tables of Changes.

BT230. VEX.L is Not Ignored with VCVT*2SI Instructions

Problem: The VEX.L bit should be ignored for the VCVTSS2SI, VCVTSD2SI, VCVTTSS2SI, and VCVTTSD2SI instructions, however due to this erratum the VEX.L bit is not ignored and will cause a #UD.

Implication: Unexpected #UDs will be seen when the VEX.L bit is set to 1 with VCVTSS2SI, VCVTSD2SI, VCVTTSS2SI, and VCVTTSD2SI instructions.

Workaround: Software should ensure that the VEX.L bit is set to 0 for all scalar instructions.

Status: For the affected steppings, see the Summary Tables of Changes.

BT231. The System Agent Temperature is Not Available

Problem: Due to this erratum, the processor does not record the temperature of the System Agent in the Temperature field in bits [7:0] of the SA_TEMPERATURE CSR (Device 10; Function 2; Offset: 044h).

Implication: Firmware cannot read the temperature of the System Agent via accessing the SA_TEMPERATURE CSR.

Workaround: None Identified. The System Agent temperature is available via PECI RdPkgConfig Command service, parameter value 00FFh.

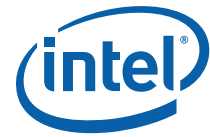

Status: For the affected steppings, see the Summary Tables of Changes.

BT232. An ACM Error May Cause a System Power Down

Problem: An Intel TXT (Intel Trusted Executed Technology) enabled system that detects an ACM (Authenticated Code Module) error should perform a warm reset then start-up in non-trusted mode. Due to this erratum, an ACM error may cause the system to power down.

Implication: The system may unexpectedly power down.

Workaround: It is possible for the BIOS to contain a workaround for this erratum.

Status: For the affected steppings, see the Summary Tables of Changes.

BT233. Incorrect Retry Packets May Be Sent by a PCIe x16 Port Operating at 8 GT/s

Problem: A PCIe x16 port operating at 8 GT/s transmitting 256 byte Completion TLPs may not replay TLPs correctly.

Implication: Due to this erratum, unpredictable system behavior may result when a 256 byte Completion TLP is replayed on a PCIe x16 port operating at 8 GT/s.

Workaround: A BIOS code change has been identified and may be implemented as a workaround for this erratum.

Status: For the affected steppings, see the Summary Tables of Changes.

BT234. Intel® QuickData Technology May Incorrectly Signal a Master Abort

Problem: Under complex conditions, a Master Abort error suffered by an Intel QuickData Technology DMA channel running non-RAID operations may be reported for both the failing transfer and a transfer on a different channel actively performing RAID operations. Note that Master Abort errors on Intel QuickData Technology DMA transfers are unusual, generally indicating DMA transfer configuration errors.

Implication: Due to this erratum, RAID Intel QuickData Technology transfers may receive spurious Master Abort errors.

Workaround: None identified. To avoid this erratum: (1) ensure non-RAID operations do not receive any Master Aborts errors, (2) do not request fencing (by asserting bit 4) or interrupt on completion (by asserting bit 0) in the Descriptor Control Field, or (3) do not use RAID operations.

Status: For the affected steppings, see the Summary Tables of Changes.

BT235. MCI_ADDR May be Incorrect For Cache Parity Errors

Problem: In cases when a WBINVD instruction evicts a line containing an address or data parity error (MCACOD of 0x124, and MSCOD of 0x10), the address of this error should be logged in the MCI_ADDR register. Due to this erratum, the logged address may be incorrect, even though MCI_Status.ADDRV (bit 63) is set.

Implication: The address reported in MCI_ADDR may not be correct for cases of a parity error found during WBINVD execution.

Workaround: None identified.

Status: For the affected steppings, see the Summary Tables of Changes.

BT236. Instruction Fetch Page-Table Walks May be Made Speculatively to Uncacheable Memory

Problem: Page-table walks on behalf of instruction fetches may be made speculatively to uncacheable (UC) memory.

Implication: If any paging structures are located at addresses in uncacheable memory that are used for memory-mapped I/O, such I/O operations may be invoked as a result of speculative



execution that would never actually occur in the executed code path. Intel has not observed this erratum with any commercially available software.

Workaround: Software should avoid locating paging structures at addresses in uncacheable memory that are used for memory-mapped I/O.

Status: For the affected steppings, see the Summary Tables of Changes.

BT237. Intel® QuickData Technology DMA Channel Write Abort Errors May Cause a Channel Hang

Problem: When the “Fence” bit in the base descriptor Control field is set, the DMA engine assures all data for that operation (and previous operations) has been written before considering a transfer complete and beginning to process the next chained base descriptor. In addition, upon completion of a transfer, the DMA engine can notify software of the completion via either an interrupt, a memory write to a programmed location, or both. Due to this erratum, the DMA engine, while processing chained DMA descriptors with fencing or interrupt completion enabled, may hang and not enter the HALT state as expected if a write error that results in an abort occurs.

Implication: A DMA transfer that suffers a write abort error when fencing or interrupt completion is enabled may hang.

Workaround: Do not enable fencing bit [4] or interrupt completion bit [0] in the Descriptor Control Field.

Status: For the affected steppings, see the Summary Tables of Changes.

BT238. The Processor May Not Properly Execute Code Modified Using A Floating-Point Store

Problem: Under complex internal conditions, a floating-point store used to modify the next sequential instruction may result in the old instruction being executed instead of the new instruction.

Implication: Self- or cross-modifying code may not execute as expected. Intel has not observed this erratum with any commercially available software.

Workaround: None identified. Do not use floating-point stores to modify code.

Status: For the affected steppings, see the Summary Tables of Changes.

BT239. Execution of GETSEC[SEXIT] May Cause a Debug Exception to be Lost

Problem: A debug exception occurring at the same time that GETSEC[SEXIT] is executed or when an EXIT doorbell event is serviced may be lost.

Implication: Due to this erratum, there may be a loss of a debug exception when it happens concurrently with the execution of GETSEC[SEXIT]. Intel has not observed this erratum with any commercially available software.

Workaround: None identified.

Status: For the affected steppings, see the Summary Tables of Changes.

BT240. Warm Reset May Cause PCIe Hot-Plug to Fail

Problem: The Integrated I/O unit uses the VPP (Virtual Pin Port) to communicate with devices that interface to the switches and LEDs associated with PCIe Hot-Plug sequencing. Due to this erratum, VPP operation stalls when a warm reset occurs and then experiences delayed reset. Depending on timing alignment with the warm reset event, a VPP transaction in progress around the time of a warm reset may suffer an extended stall or an immediate termination.

Implication: Hot-Plug sequencing may suffer failures during or shortly after warm resets which may be temporary or persist until the next cold reset.

Workaround: None identified.

Status: For the affected steppings, see the Summary Tables of Changes.

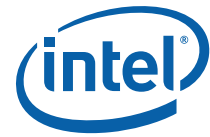

BT241. Certain Local Memory Read / Load Retired PerfMon Events May Undercount

Problem: Due to this erratum, the Local Memory Read / Load Retired PerfMon events listed below may undercount.

MEM_LOAD_UOPS_RETIREDD.LLC_HIT
MEM_LOAD_UOPS_RETIREDD.LLC_MISS*
MEM_LOAD_UOPS_LLC_HIT_RETIREDD.XSNP_MISS
MEM_LOAD_UOPS_LLC_HIT_RETIREDD.XSNP_HIT
MEM_LOAD_UOPS_LLC_HIT_RETIREDD.XSNP_HITM
MEM_LOAD_UOPS_LLC_HIT_RETIREDD.XSNP_NONE
MEM_LOAD_UOPS_LLC_MISS_RETIREDD.LOCAL_DRAM*
MEM_LOAD_UOPS_LLC_MISS_RETIREDD.REMOTE_DRAM*
MEM_TRANS_RETIREDD.LOAD_LATENCY*

Implication: The affected events may undercount, resulting in inaccurate memory profiles

Workaround: The undercount of these events can be partially resolved (but not eliminated) by setting MSR_PEBS_NUM_ALT. PEBS Accuracy Enable (MSR 39CH; bit 0) to 1. When using the events marked with an asterisk, set the Direct-to-core disable field (Bus 1; Device 14; Function 0; Offset 84; bit 1) to 1 for Local memory reads and (Bus 1; Device 8; Function 0; Offset 80; bit 1) to 1 and (Bus 1; Device 9; Function 0; Offset 80; bit 1) to 1 for Remote memory reads. The improved accuracy comes at the cost of a reduction in performance; this workaround generally should not be used during normal operation.

Status: For the affected steppings, see the Summary Tables of Changes.

BT242. IA32_MC5_CTL2 is Not Cleared by a Warm Reset

Problem: IA32_MC5_CTL2 MSR (285H) is documented to be cleared on any reset. Due to this erratum this MSR is only cleared upon a cold reset.

Implication: The algorithm documented in Software Developer's Manual, Volume 3, section titled "CMCI Initialization" or any other algorithm that counts the IA32_MC5_CTL2 MSR being cleared on reset will not function as expected after a warm reset.

Workaround: None identified.

Status: For the affected steppings, see the Summary Tables of Changes.

BT243. Performance Monitor Counters May Produce Incorrect Results

Problem: When operating with SMT enabled, a memory at-retirement performance monitoring event (from the list below) may be dropped or may increment an enabled event on the corresponding counter with the same number on the physical core's other thread rather than the thread experiencing the event. Processors with SMT disabled in BIOS are not affected by this erratum

The list of affected memory at-retirement events is as follows:

MEM_UOP_RETIREDD.LOADS
MEM_UOP_RETIREDD.STORES
MEM_UOP_RETIREDD.LOCK
MEM_UOP_RETIREDD.SPLIT
MEM_UOP_RETIREDD.STLB_MISS
MEM_LOAD_UOPS_RETIREDD.HIT_LFB
MEM_LOAD_UOPS_RETIREDD.L1_HIT
MEM_LOAD_UOPS_RETIREDD.L2_HIT
MEM_LOAD_UOPS_RETIREDD.LLC_HIT
MEM_LOAD_UOPS_LLC_HIT_RETIREDD.XSNP_HIT
MEM_LOAD_UOPS_LLC_HIT_RETIREDD.XSNP_HITM
MEM_LOAD_UOPS_LLC_HIT_RETIREDD.XSNP_MISS
MEM_LOAD_UOPS_LLC_HIT_RETIREDD.XSNP_NONE



MEM_LOAD_UOPS_RETIRED.LLC_MISS
MEM_LOAD_UOPS_LLC_MISS_RETIRED.LOCAL_DRAM
MEM_LOAD_UOPS_LLC_MISS_RETIRED.REMOTE_DRAM
MEM_LOAD_UOPS_RETIRED.L2_MISS

Implication: Due to this erratum, certain performance monitoring event will produce unreliable results during hyper-threaded operation.

Workaround: None identified.

Status: For the affected steppings, see the Summary Tables of Changes.

BT244. The Corrected Error Count Overflow Bit in IA32_MCO_STATUS is Not Updated After a UC Error is Logged

Problem: When a UC (uncorrected) error is logged in the IA32_MCO_STATUS MSR (401H), corrected errors will continue to update the lower 14 bits (bits 51:38) of the Corrected Error Count. Due to this erratum, the sticky count overflow bit (bit 52) of the Corrected Error Count will not get updated after a UC error is logged.

Implication: The Corrected Error Count Overflow indication will be lost if the overflow occurs after an uncorrectable error has been logged.

Workaround: None identified.

Status: For the affected steppings, see the Summary Tables of Changes.

BT245. IA32_VMX_VMCS_ENUM MSR (48AH) Does Not Properly Report The Highest Index Value Used For VMCS Encoding

Problem: IA32_VMX_VMCS_ENUM MSR (48AH) bits 9:1 report the highest index value used for any VMCS encoding. Due to this erratum, the value 21 is returned in bits 9:1 although there is a VMCS field whose encoding uses the index value 23.

Implication: Software that uses the value reported in IA32_VMX_VMCS_ENUM[9:1] to read and write all VMCS fields may omit one field.

Workaround: None identified.

Status: For the affected steppings, see the Summary Tables of Changes.

BT246. The Upper 32 Bits of CR3 May be Incorrectly Used With 32-Bit Paging

Problem: When 32-bit paging is in use, the processor should use a page directory located at the 32-bit physical address specified in bits 31:12 of CR3; the upper 32 bits of CR3 should be ignored. Due to this erratum, the processor will use a page directory located at the 64-bit physical address specified in bits 63:12 of CR3.

Implication: The processor may use an unexpected page directory or, if EPT (Extended Page Tables) is in use, cause an unexpected EPT violation. This erratum applies only if software enters 64-bit mode, loads CR3 with a 64-bit value, and then returns to 32-bit paging without changing CR3. Intel has not observed this erratum with any commercially available software.

Workaround: Software that has executed in 64-bit mode should reload CR3 with a 32-bit value before returning to 32-bit paging.

Status: For the affected steppings, see the Summary Tables of Changes.

BT247. EPT Violations May Report Bits 11:0 of Guest Linear Address Incorrectly

Problem: If a memory access to a linear address requires the processor to update an accessed or dirty flag in a paging-structure entry and if that update causes an EPT violation, the processor should store the linear address into the "guest linear address" field in the VMCS. Due to this erratum, the processor may store an incorrect value into bits 11:0 of this field. (The processor correctly stores the guest-physical address of the paging-structure entry into the "guest-physical address" field in the VMCS.)

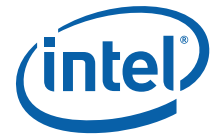

Implication: Software may not be easily able to determine the page offset of the original memory access that caused the EPT violation. Intel has not observed this erratum to impact the operation of any commercially available software.

Workaround: Software requiring the page offset of the original memory access address can derive it by simulating the effective address computation of the instruction that caused the EPT violation.

Status: For the affected steppings, see the Summary Tables of Changes.

BT248. Virtual-APIC Page Accesses With 32-Bit PAE Paging May Cause a System Crash

Problem: If a logical processor has EPT (Extended Page Tables) enabled, is using 32-bit PAE paging, and accesses the virtual-APIC page then a complex sequence of internal processor micro-architectural events may cause an incorrect address translation or machine check on either logical processor.

Implication: This erratum may result in unexpected faults, an uncorrectable TLB error logged in IA32_MCi_STATUS.MCACOD (bits [15:0]) with a value of 0000_0000_0001_xxxx (where x stands for 0 or 1), a guest or hypervisor crash, or other unpredictable system behavior.

Workaround: It is possible for the BIOS to contain a workaround for this erratum.

Status: For the affected steppings, see the Summary Tables of Changes.

BT249. PCIe* Header of a Malformed TLP is Logged Incorrectly

Problem: If a PCIe port receives a malformed TLP (Transaction Layer Packet), an error is logged in the UNCERRSTS register (Device 0; Function 0; Offset 14CH and Device 2-3; Function 0-3; Offset 14CH). Due to this erratum, the header of the malformed TLP is logged incorrectly in the HDRLOG register (Device 0; Function 0; Offset 164H and Device 2-3; Function 0-3; Offset 164H).

Implication: The PCIe header of a malformed TLP is not logged correctly.

Workaround: None identified.

Status: For the affected steppings, see the Summary Tables of Changes.

BT250. VM Exit May Set IA32_EFER.NXE When IA32_MISC_ENABLE Bit 34 is Set to 1

Problem: When "XD Bit Disable" in the IA32_MISC_ENABLE MSR (1A0H) bit 34 is set to 1, it should not be possible to enable the "execute disable" feature by setting IA32_EFER.NXE. Due to this erratum, a VM exit that occurs with the 1-setting of the "load IA32_EFER" VM-exit control may set IA32_EFER.NXE even if IA32_MISC_ENABLE bit 34 is set to 1. This erratum can occur only if IA32_MISC_ENABLE bit 34 was set by guest software in VMX non-root operation.

Implication: Software in VMX root operation may execute with the "execute disable" feature enabled despite the fact that the feature should be disabled by the IA32_MISC_ENABLE MSR. Intel has not observed this erratum with any commercially available software.

Workaround: A virtual-machine monitor should not allow guest software to write to the IA32_MISC_ENABLE MSR.

Status: For the affected steppings, see the Summary Tables of Changes.

BT251. Platform Recovery After a Machine Check May Fail

Problem: While attempting platform recovery after a machine check (as indicated by CATERR# signaled from the legacy socket), the original error condition may prevent normal platform recovery which can lead to a second machine check. A remote processor detecting a second Machine Check Event will hang immediately.

Implication: Due to this erratum, it is possible a system hang may be observed during a warm reset caused by a CATERR#.

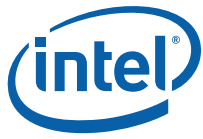

Workaround: None identified.

Status: For the affected steppings, see the Summary Tables of Changes.

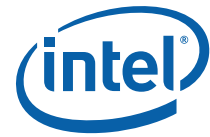

BIOS ACM Errata

1. BIOS ACM Erratum Removed.

2. BIOS ACM Erratum Removed.

3. BIOS ACM Erratum Removed.

4. BIOS ACM Erratum Removed.

5. BIOS ACM Unexpected Write to the PCI F000 Segment and S3 Resume Failure.

Problem: With affected BIOS ACMs, SCHECK may make an unexpected write to the PCI F000 Segment and BIOS ACM S3 Resume may fail.

Implication: The unexpected write to the PCI F000 Segment may result in unexpected platform behavior. Also, BIOS ACM S3 Resume may fail without reporting an error code to BIOS, causing unexpected behavior including TPM PCRs 1-8 being cleared.

Workaround: None.

Status: For the affected revision, see the BIOS ACM and SINIT ACM Errata Summary table.

6. TPM Errors may cause the BIOS ACM to hang

Problem: If a TPM error condition such as a missing or non-functional TPM occurs, the BIOS ACM should hand off to BIOS with a TPM error code to indicate that Intel TXT launch is not possible. With this erratum, a TPM error may result in a BIOS ACM hang instead of hand-off to BIOS with a TPM error code.

Implication: Intel TXT-enabled platforms may hang during BIOS boot if a TPM error occurs.

Workaround: None.

Status: For the affected revision, see the BIOS ACM and SINIT ACM Errata Summary table.

7. TPM Policy Record with MMIO May Not Behave as Expected

Problem: TPM Policy Record (FIT Type 8 Entry) using MMIO may not correctly enable/disable Intel TXT.

Implication: TPM Policy Record (FIT Type 8 Entry) using MMIO may not correctly enable/disable Intel TXT.

Workaround: For the affected revision, see the BIOS ACM and SINIT ACM Errata Summary table. TPM Policy Record with I/O read is not affected by this erratum.

Status: For the affected revision, see the BIOS ACM and SINIT ACM Errata Summary table.

8. Intel TXT Policy Record with MMIO May Not Behave as Expected

Problem: Intel TXT Policy Record (FIT Type 10 Entry) using MMIO may not correctly enable/disable Intel TXT.

Implication: Intel TXT Policy Record (FIT Type 10 Entry) using MMIO may not correctly enable/disable Intel TXT.

Workaround: Intel TXT Policy Record with I/O read is not affected by this erratum.

Status: For the affected revision, see the BIOS ACM and SINIT ACM Errata Summary table.

9. Intel TXT Policy May Not Default to Enabled

Problem: If a FIT table is present and the FIT Type 10 Record is missing, Intel TXT policy may not default to enabled.



Implication: Intel TXT may be disabled if the FIT table is present, but the FIT Type 10 record is missing.

Workaround: Implement a FIT Type 10 record to ensure that Intel TXT is properly enabled or disabled.

Status: For the affected revision, see the BIOS ACM and SINIT ACM Errata Summary table.

10. Intel® Trusted Execution Technology BIOS ACM leaves Memory locked When the Coin Battery is removed and the TPM is not populated

Problem: TXT.E2STS (Offset 0x8F0) SECRETS.STS (bit 1) = 0 and BLOCK-MEM.STS (bit 2) = 1 indicates that the PCH CMOS memory has been cleared (for example, coin battery removal). At reset if TXT.E2STS indicates that the MLE established secrets (SECRETS.STS = 1) or the coin battery has been removed, TXT.ESTS (Offset 0x08) WAKE-ERROR.STS (bit 6) will be set to indicate that a reset occurred when secrets may have been present in memory. With affected BIOS ACM releases, when the coin battery is removed and the TPM is not populated, the BIOS ACM will exit with an error condition, WAKE-ERROR.STS is not cleared, and memory remains locked.

Implication: With affected BIOS ACM releases, unexpected TPM accesses may occur and/or the memory controller may be locked when the coin battery is removed and the TPM is not populated.

Workaround: None identified.

Status: For the affected revision, see the BIOS ACM and SINIT ACM Errata Summary table.

11. BIOS ACM errors may result in unexpected TPM locality change command

Problem: BIOS ACM errors may result in unexpected TPM locality change command, even if Intel TXT is disabled using the Firmware Interface Table Intel TXT Policy record or the TPM is not populated.

Implication: While the BIOS ACM waits for the TPM command to timeout, a BIOS timeout or other unexpected behavior may occur.

Workaround: None identified.

Status: For the affected revision, see the BIOS ACM and SINIT ACM Errata Summary table.

12. BIOS ACM Error Condition May Result In Unexpected Behavior

Problem: With affected BIOS ACMs, an error condition that invokes BIOS ACM error handling may cause a multiprocessor synchronization issue to be exposed.

Implication: On multiprocessor system, a BIOS ACM error condition may result in BIOS ACMs start executing an S3 resume or hot-plug flow or other unexpected behavior may occur.

Workaround: None identified.

Status: For the affected revision, see the BIOS ACM and SINIT ACM Errata Summary table.

13. Reset due to Intel® Trusted Execution Technology Error Condition May Result in BIOS Hang or Unexpected Behavior

Problem: An Intel TXT error condition may cause a platform warm reset to occur and expose a multiprocessor synchronization issue during the warm reset latency.

Implication: A BIOS hang or other unexpected behavior may occur on multiprocessor platforms when an Intel TXT error condition causes a platform reset to occur.

Workaround: None

Status: For the affected revision, see the BIOS ACM and SINIT ACM Errata Summary table.

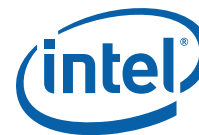

14. BIOS ACM Changes to the PCI Configuration Space May Cause Unexpected Behavior

Problem: When an Intel(R) TXT error occurs on a multiprocessor system, BIOS ACM changes to the PCI configuration space may occur before all processors have completed their PCIe transactions.

Implication: With affected BIOS ACMs, an Intel(R) TXT error on a multiprocessor system may result in a PCIe transaction not completing, a system hang, or other unexpected behavior.

Workaround: None

Status: For the affected revision, see the BIOS ACM and SINIT ACM Errata Summary table.

15. TPM Hang May Result in BIOS Hang or Other Unexpected Behavior

Problem: If the TPM fails to respond to locality change commands, the BIOS ACM may exit leaving processor configuration status registers in a state that could cause a BIOS hang or unexpected behavior.

Implication: A BIOS hang or other unexpected behavior may occur on Intel® TXT-enabled platforms if the TPM fails to respond to a locality change commands

Workaround: None

Status: For the affected revision, see the BIOS ACM and SINIT ACM Errata Summary table.

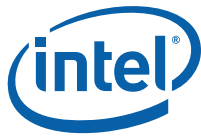

SINIT ACM Errata

1. SINIT ACM Erratum Removed

2. SINIT ACM Erratum Removed

3. SINIT ACM Does Not Support the ACPI 2.0 64-bit XSDT table

Problem: Affected SINIT ACMs do not support the ACPI 2.0 64-bit XSDT table.

Implication: If a platform provides the 64-bit XSDT table without a 32-bit RSDT table, GETSEC[SENDER] will fail with TXT.ERRORCODE reporting "RSDT checksum error."

Workaround: BIOS implementations can implement both the 32-bit RSDT table and the 64-bit XSDT table.

Status: For the affected revision, see the BIOS ACM and SINIT ACM Errata Summary table.

4. SINIT ACM Erratum Removed

5. SINIT ACM Erratum Removed

6. SENTER may not identify incorrectly programmed Intel(R) QuickData Technology Base Address Registers

Problem: SENTER may not identify overlap errors between Intel(R) I/O Device Virtualization Base Address Registers and Intel(R) QuickData Base Technology Address Registers.

Implication: Incorrectly programmed Intel(R) QuickData Technology Base Address Registers may not be identified by SINIT ACM SENTER.

Workaround: BIOS should avoid overlap when programming the Intel(R) QuickData Technology Base Address Registers.

Status: For the affected revision, see the BIOS ACM and SINIT ACM Errata Summary table.

7. SENTER Performs Incorrect Checks on TPM Locality 1 and 4

Problem: SENTER Performs Incorrect Checks on TPM Locality 1 and 4

Implication: If TPM Locality 1 is active at Intel TXT software launch, PCR17 extension may fail. If TPM Locality 4 is active at Intel TXT software launch, an erroneous SINIT ACM error may be reported.

Workaround: TPM Localities 0 - 3 should be inactive at Intel TXT software launch.

Status: For the affected revision, see the BIOS ACM and SINIT ACM Errata Summary table.

Problem: SINIT Authenticated Code Modules (ACMs) may be susceptible to a buffer overflow issue.

Implication: When Intel TXT measured launch is invoked using affected SINIT Authenticated Code Modules, the platform is susceptible to an OS kernel-level exploit which may compromise certain SINIT ACM functionality.

Workaround: It is possible for a BIOS update and an updated SINIT ACM to be used as a workaround for this erratum. Previous SINIT ACM releases will no longer function with the BIOS update.

Status: For the affected revision, see the BIOS ACM and SINIT ACM Errata Summary table.

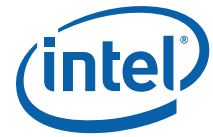

Specification Changes

The Specification Changes listed in this section apply to the following documents:

- *Intel® Xeon® Processor E5-1600/E5-2600/E5-4600 Product Families Datasheet - Volume One, Revision 326508-002*
- *Intel® Xeon® E5-2400 Product Family Datasheet- Volume One, Revision 327248-001*
- *Intel® Xeon® Processor E5-1600/E5-2400/E5-2600/E5-4600 Product Families Datasheet - Volume Two, Revision 326509-003*
- *Intel® 64 and IA-32 Architectures Software Developer's Manual, Volume 1: Basic Architecture*
- *Intel® 64 and IA-32 Architectures Software Developer's Manual, Volume 2A: Instruction Set Reference Manual A-M*
- *Intel® 64 and IA-32 Architectures Software Developer's Manual, Volume 2B: Instruction Set Reference Manual N-Z*
- *Intel® 64 and IA-32 Architectures Software Developer's Manual, Volume 3A: System Programming Guide*
- *Intel® 64 and IA-32 Architectures Software Developer's Manual, Volume 3B: System Programming Guide*

1. **There are no Specification Changes at this time.**



Specification Clarifications

The Specification Clarifications listed in this section apply to the following documents:

- *Intel® Xeon® Processor E5-1600/E5-2600/E5-4600 Product Families Datasheet - Volume One, Revision 326508-002*
- *Intel® Xeon® E5-2400 Product Family Datasheet- Volume One, Revision 327248-001*
- *Intel® Xeon® Processor E5-1600/E5-2400/E5-2600/E5-4600 Product Families Datasheet - Volume Two, Revision 326509-003*
- *Intel® 64 and IA-32 Architectures Software Developer's Manual, Volume 1: Basic Architecture*
- *Intel® 64 and IA-32 Architectures Software Developer's Manual, Volume 2A: Instruction Set Reference Manual A-M*
- *Intel® 64 and IA-32 Architectures Software Developer's Manual, Volume 2B: Instruction Set Reference Manual N-Z*
- *Intel® 64 and IA-32 Architectures Software Developer's Manual, Volume 3A: System Programming Guide*
- *Intel® 64 and IA-32 Architectures Software Developer's Manual, Volume 3B: System Programming Guide*

1. EDS Volume 2

The use of CSEG for SMM RAM is no longer supported in the E5 product family. E5r specifications mention the ability to map SMM RAM into the compatibility segment – specifically the A0000 – BFFFF range through a facility called SMRAMC in the uncore.

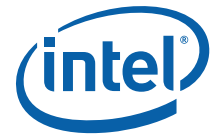

Documentation Changes

The Documentation Changes listed in this section apply to the following documents:

- *Intel® Xeon® Processor E5-1600/E5-2600/E5-4600 Product Families Datasheet - Volume One, Revision 326508-002*
- *Intel® Xeon® E5-2400 Product Family Datasheet- Volume One, Revision 327248-001*
- *Intel® Xeon® Processor E5-1600/E5-2400/E5-2600/E5-4600 Product Families Datasheet - Volume Two, Revision 326509-003*
- *Intel® 64 and IA-32 Architectures Software Developer's Manual, Volume 1: Basic Architecture*
- *Intel® 64 and IA-32 Architectures Software Developer's Manual, Volume 2A: Instruction Set Reference Manual A-M*
- *Intel® 64 and IA-32 Architectures Software Developer's Manual, Volume 2B: Instruction Set Reference Manual N-Z*
- *Intel® 64 and IA-32 Architectures Software Developer's Manual, Volume 3A: System Programming Guide*
- *Intel® 64 and IA-32 Architectures Software Developer's Manual, Volume 3B: System Programming Guide*

All Documentation Changes will be incorporated into a future version of the appropriate Processor documentation.

Note: Documentation changes for Intel® 64 and IA-32 Architecture Software Developer's Manual volumes 1, 2A, 2B, 3A, and 3B will be posted in a separate document, Intel® 64 and IA-32 Architecture Software Developer's Manual Documentation Changes. Follow the link below to become familiar with this file.

<http://www.intel.com/content/www/us/en/processors/architectures-software-developer-manuals.html>

1. **Datasheet Volume 2: Table 4.7.2.3 (IntControl: Interrupt Control Register):**

Bits 6:4 with a decode of 001b should read:

Round robin mode, applicable only in extended mode, not Redirect last vector selected (applicable only in extended mode)

2. **Datasheet Volume 2: VTDO_EXT_CAP register:**

Bit 3 and bit 2 Attr (attribute) should be listed as RO

3. **Datasheet Volume 2: I/O APIC Capability List Implementation**

The following changes are made to the section:



Integrated I/O Core Registers

Table 9. I/OxAPIC PCI Configuration Space Map - Device 5/Function 4: Offset 0x00-0xFF

DID	VID	0h		RDINDEX	80h
PCISTS	PCICMD	4h			84h
CCR	RID	8h			88h
HDR	CLSR	Ch			8Ch
MBAR		10h		RDWINDOW	90h
		14h			94h
		18h			98h
		1Ch			9Ch
		20h		IOAPICTETPC	A0h
		24h			A4h
		28h			A8h
SDID	SVID	2Ch			ACh
		30h			B0h
		CAPPTR	34h		B4h
			38h		B8h
		INTPIN	INTL	3Ch	BCh
		ABAR		40h	C0h
				44h	C4h
				48h	C8h
				4Ch	CCh
				50h	D0h
				54h	D4h
				58h	D8h
				5Ch	DCh
				60h	E0h
				64h	E4h
				68h	E8h
PMCAP				6Ch	ECh
PMCSR				70h	F0h
				74h	F4h
				78h	F8h
				7Ch	FCh

Table. I/OxAPIC PCI Configuration Space Map - Device 5/Function 4: Offset 0x200-0x2FF

This table is removed.

CAPPTR: Capability Pointer

The pointer for Bus: 0, Device: 5, Function: 4 is changed to 6Ch



The CAPPTR provides the offset to the location of the first device capability in the capability list.

CAPPTR Bus: 0 Device: 5Function: 0,2,4Offset: 34h			
Bit	Attr	Default	Description
7:0	RO	Dev 5, Function 0,2= 40h Dev 5, Function 4 = 6Ch	Capability Pointer Points to the first capability structure for the device. Which is the PCIe capability for Function 0 and 2 and is PMCAP for Function 4.

PXPCAP: PCI Express Capabilities Register

The PCI Express Capability for Bus: 0, Device: 5, Function: 4: Offset 42h is removed.

The PCI Express Capability List register enumerates the PCI Express Capability structure in the PCI 3.0 configuration space.

PXPCAP Bus: 0 Device: 5Function: 0, 2Offset: 42h			
Bit	Attr	Default	Description
15:14	RV	0h	Reserved
13:9	RO	00h	Interrupt Message Number N/A
8	RO	0b	Slot Implemented N/A
7:4	RO	1001b	Device/Port Type This field identifies the type of device. It is set to for the DMA to indicate root complex integrated endpoint device.
3:0	RO	2h	Capability Version This field identifies the version of the PCI Express capability structure. Set to 2h for PCI Express and DMA devices for compliance with the extended base registers.

IOADSELS0: IOxAPIC DSELS Register 0

This section is removed.

IOADSELS1: IOxAPIC DSELS Register 1

This section is removed.

IOINTSRC0: IO Interrupt Source Register 0

This section is removed.

IOINTSRC1: IO Interrupt Source Register 1

This section is removed.

IOREMINTCNT: Remote IO Interrupt Count

This section is removed.

IOREMGPECNT: Remote IO GPE Count

This section is removed.

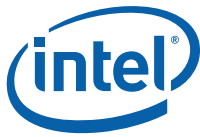

IOXAPICPARERRINJCTL: IOxAPIC Parity Error Injection Control

This section is removed.

FAUXGV: FauxGV

This section is removed.

4. Datasheet Volume 1: Statement of Volatility

No Intel® Xeon® Processor E5 Family processors retain any end user data when powered down and/or when the parts are physically removed from the socket.

5. Datasheet Volume 2: IRP_MISC_DFX0: Coherent Interface Miscellaneous DFx 0

Updated Aging Timer Rollover value definitions.

6. Datasheet Volume 1: E5-1600 Product Family Definitions

IRP_MISC_DFX0 Bus: 0 Device: 5Function: 0Offset: 800h			
Bit	Attr	Default	Description
23:22	RW-L	00b	Aging Timer Rollover 0: disabled 1: 32 us 2: 4 us 3: 2 us There is a timing error range +100% to -0% of the intervals listed Notes: Locked by DBGBUSLCK

1.1 Introduction

The Intel® Xeon® processor E5-1600 product family is designed for entry level workstation platforms. The Intel® Xeon® processor E5-2600 product family is designed for Efficient Performance server, workstation and HPC platforms. The Intel® Xeon® processor E5-4600 product family processor supports scalable server and HPC platforms of two or more processors, including “glueless” 4-way platforms. Note: some processor features are not available on all platforms.

1.6 Terminology

Intel® Xeon® processor E5-1600 product family	Intel's 32-nm processor design, follow-on to the 32-nm Sandy Bridge processor design. It is the first processor for use in Romley-EP platforms. Intel® Xeon® processor E5-1600 product family supports single Socket entry level Workstation platforms
Intel® Xeon® processor E5-2600 product family	Intel's 32-nm processor design, follow-on to the 32-nm Sandy Bridge processor design. It is the first processor for use in Romley-EP platforms. Intel® Xeon® processor E5-2600 product family supports Efficient Performance server, workstation and HPC platforms
Scalable-2S	Intel® Xeon® processor E5-4600 product families-based Platform targeted for scalable designs using third party Node Controller chip. In these designs, Node Controller is used to scale the design beyond one/two/four sockets.

1.2.1 System Memory Support

Note: The features listed are a superset of features. Eg: LRDIMM x4 x8 and RAS is not supported on Workstations.

7. Datasheet Volume 1: E5-1600 Product Family Thermal Definitions

5.1.3.4 6-Core 130W 1S Workstation Thermal Specifications

Figure 5-8. Tcase: 6-Core 130W 1S Workstation Thermal Profile

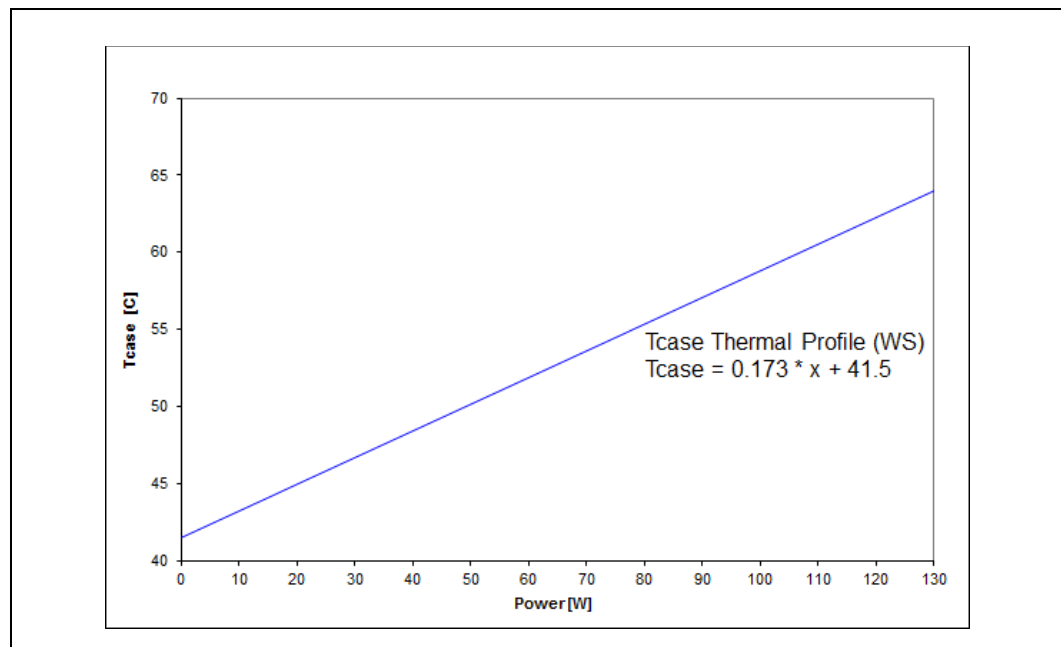
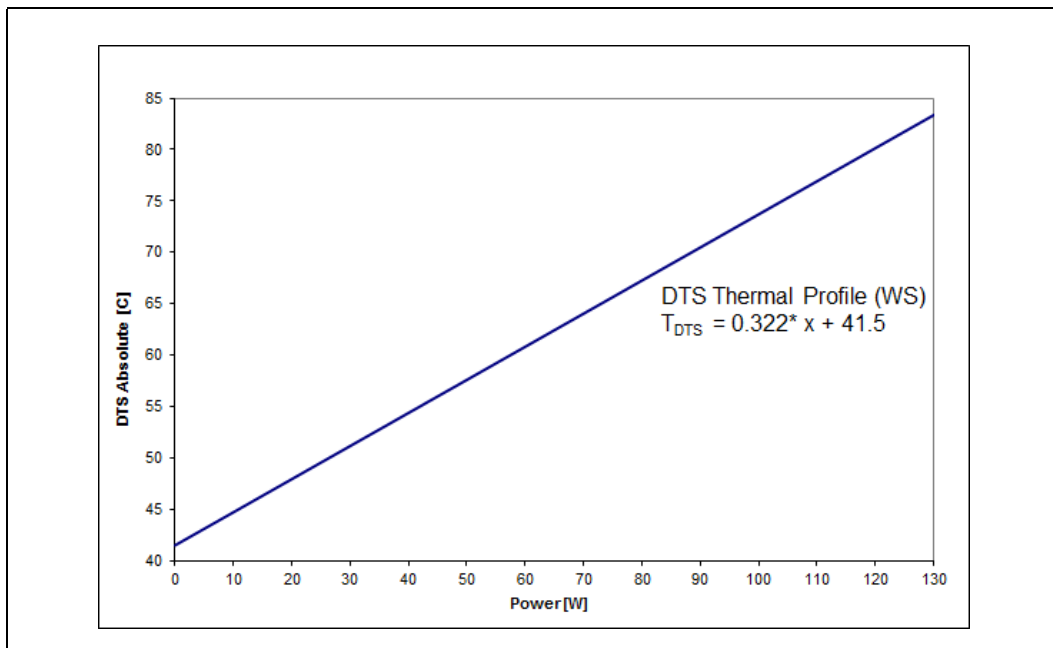



Figure 5-9. DTS: 6-Core 130W 1S Workstation Thermal Profile



5.1.3.10 4-Core 130W 1S Workstation Thermal Specifications

Table 5-20. Tcase: 4-Core 130W 1S Workstation Thermal Specifications, Workstation Only Platform

Core Frequency	Thermal Design Power (W)	Minimum T _{CASE} (°C)	Maximum T _{CASE} (°C)	Notes
Launch to FMB	130	5	See Figure 5-21 and Table 5-21	1, 2, 3, 4, 5

8. SDM, Volume 3B: On-Demand Clock Modulation Feature Clarification

Software Controlled Clock Modulation section of the *Intel® 64 and IA-32 Architectures Software Developer's Manual, Volume 3B: System Programming Guide* will be modified to differentiate On-demand clock modulation feature on different processors. The clarification will state:

For Intel® Hyper-Threading Technology enabled processors, the IA32_CLOCK_MODULATION register is duplicated for each logical processor. In order for the On-demand clock modulation feature to work properly, the feature must be enabled on all the logical processors within a physical processor. If the programmed duty cycle is not identical for all the logical processors, the processor clock will modulate to the highest duty cycle programmed for processors if the CPUID DisplayFamily_DisplayModel signatures is listed in Table 14-2. For all other processors, if the programmed duty cycle is not identical for all logical processors in the same core, the processor will modulate at the lowest programmed duty cycle.

For multiple processor cores in a physical package, each core can modulate to a programmed duty cycle independently.

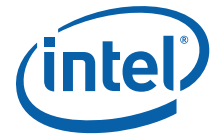

For the P6 family processors, on-demand clock modulation was implemented through the chipset, which controlled clock modulation through the processor's STPCLK# pin.

Table 14-2. CPUID Signatures for Legacy Processors That Resolve to Higher Performance Setting of Conflicting Duty Cycle Requests

Table 14-2. CPUID Signatures for Legacy Processors That Resolve to Higher Performance Setting of Conflicting Duty Cycle Requests

DisplayFamily_Display Model	DisplayFamily_Display Model	DisplayFamily_Display Model	DisplayFamily_Display Model
0F_xx	06_1C	06_1A	06_1E
06_1F	06_25	06_26	06_27
06_2C	06_2E	06_2F	06_35
06_36			

9. When transient errors are injected during memory read using MEI tool, CORRERRCNT_N and IA32_MC5_STATUS[58:32] do not log same number of corrected errors

10. Datasheet Volume 1 Table 2-11, footnote 5 is incorrect for E5-2400 processors.

It should say: Intel® Xeon® processor E5-2400 product family banks 6 and 8 corresponding to Intel QPI[0] and iMC[0] are not available on this processor. Reading any registers within these banks will return all '0's.

11. Datasheet Volume 2: Figure 1-1 Processor Integrated I/O Device Map.

The drawing in the current EDS Volume 2 does not include devices 6 and 7. These are internal devices not generally accessible on production systems. The drawing below is correct.

Device 6, 7: PCI Express Dfx. Contains the PCI Express debug (DFx), Lock, Error Inject Registers.

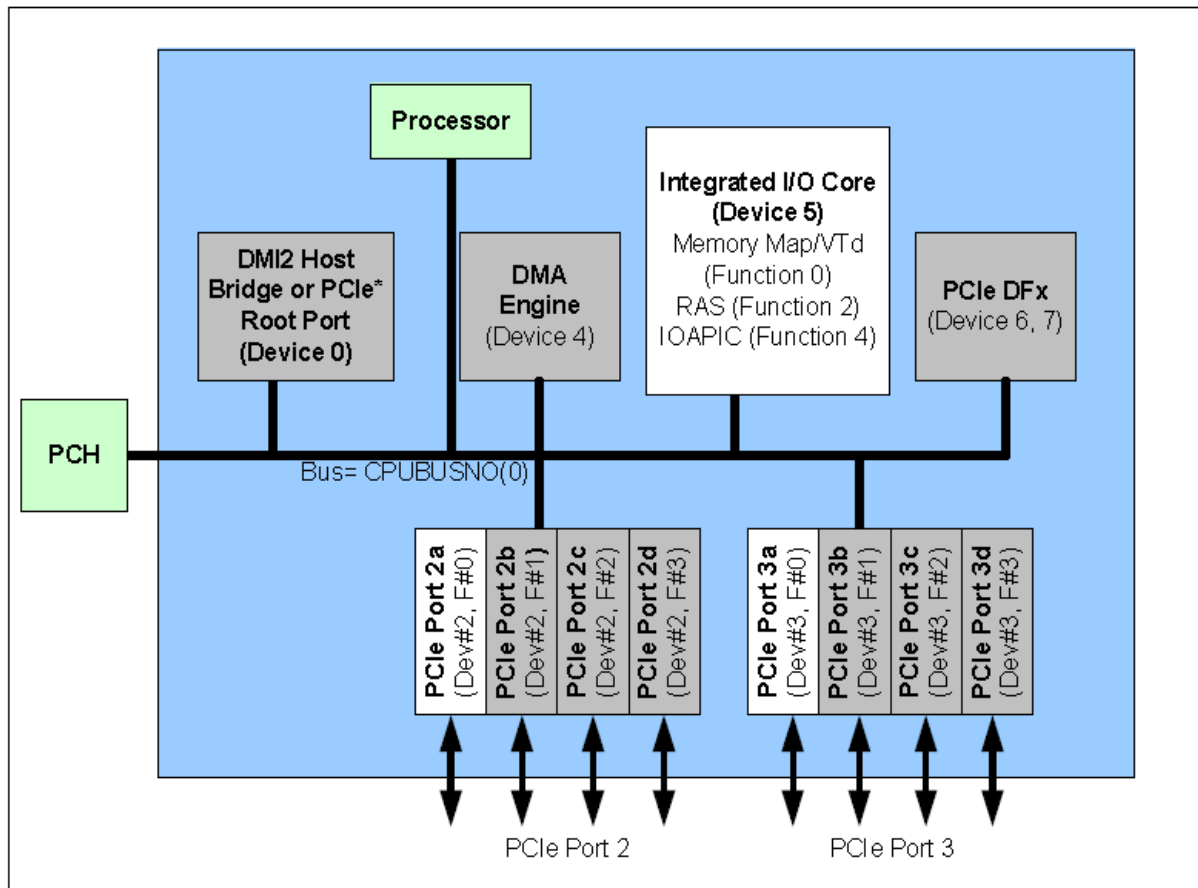
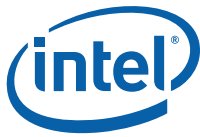

12. Local Peer to Peer PCIe transactions:

To support local (same CPU) peer-to-peer PCIe transactions, the following registers must be programmed: LMMIOx_BASE and LMMIOx_LIMIT. Local peer-to-peer transactions may **not** cross the coherent interface ("the Ring") since this is not a POR or validated method for local peer-to-peer transactions.

For a small BAR (32 bits), the LMMIOL_BASE and LMMIOL_LIMIT registers must be programmed. For a large BAR (64 bit), the LMMIOH_BASE and LMMIOH_LIMIT must be programmed. An example is of "small BAR programming is shown below. Large BAR programming follows a similar methodology.

For an LMMIOL_BASE[15:8] = \$FE and LMMIOL_LIMIT[15:8] = \$FF, the following 32 bit address holes are created for local peer-to-peer accesses: \$FE000000 - \$FFFFFFF. The IIO block thus does not forward addresses in this range onto the coherent interface (the ring), but rather the local PCIe agent whose BAR is programmed to match this address range will acknowledge and respond to this request.



11.6.33 LMMIOL_LIMIT

Local MMIO Low Limit.

Type: CFG		PortID: N/A	
Bus: 0		Device: 5	
Offset: 0x10e		Function: 0	
Bit	Attr	Default	Description
15:8	RW_LB	0x0	<p>limit:</p> <p>Corresponds to A[31:24] of MMIO limit. An inbound memory address that satisfies 'local MMIO base[15:8] <= A[31:24] <= local MMIO limit[15:8]' is treated as a local peer-to-peer transaction that does not cross the coherent interface.</p> <p>Note: Setting LMMIOL.BASE greater than LMMIOL.LIMIT disables local MMIO peer-to-peer. This register is programmed once at boot time and does not change after that, including any quiesce flows.</p>

13. Datasheet Volume 2: Sections 3.5.3.16 and 17:

The EDS states: Corresponds to A[50:26] of MMIOH limit. An inbound memory address that satisfies local MMIOH base [50:26] <= A[63:26] <= local MMIOH limit [50:26] is treated as local a peer2peer transactions that does not cross the coherent interface.

However it should state:

Corresponds to **A[50:26]** of Local MMIOH Limit (and Base) Address. An inbound memory address that satisfies the Local MMIO Base Address **[50:26]** <=A[63:26] <= Local MMIOH Limit Address **[50:26]**, with A[63:51] equal to zero, is treated as a local peer2peer transaction that does not cross the coherent interface (ring).

3.5.3.17 LMMIOH_LIMIT: Local MMIO High Base

LMMIOH_LIMIT		Device: 5		Function: 0		Offset: 118h	
Bus: N							
Bit	Attr	Default	Description				
63:51	RV	0h	Reserved				
50:26	RW-LB	000000 0h	<p>Local MMIOH Limit Address</p> <p>Corresponds to A[50:26] of MMIOH limit. An inbound memory address that satisfies local MMIOH base [50:26] <= A[63:26] <= local MMIOH limit [50:26] is treated as local a peer2peer transactions that does not cross the coherent interface.</p> <p>Notes: Setting LMMIOH.BASE greater than LMMIOH.LIMIT disables local MMIOH peer2peer. This register is programmed once at boot time and does not change after that, including any quiesce flows.</p>				
25:0	RV	0h	Reserved				



14. Datasheet Volume 2: Chapter 7: Additions for Intel QPI CTLE needed.

RX_CTLE_OFFSET_EN

Type: CFG PortID:N/A Bus: 1 Device:8Function:4 Bus: 1 Device:9Function:4 Offset: 0x684			
Bit	Attr	Default	Description
25:25	RWS_L	0x1	lane19:
24:24	RWS_L	0x1	lane18:
23:23	RWS_L	0x1	lane17:
22:22	RWS_L	0x1	lane16:
21:21	RWS_L	0x1	lane15:
20:20	RWS_L	0x1	lane14:
19:19	RWS_L	0x1	lane13:
18:18	RWS_L	0x1	lane12:
17:17	RWS_L	0x1	lane11:
16:16	RWS_L	0x1	lane10:
9:9	RWS_L	0x1	lane9:
8:8	RWS_L	0x1	lane8:
7:7	RWS_L	0x1	lane7:
6:6	RWS_L	0x1	lane6:
5:5	RWS_L	0x1	lane5:
4:4	RWS_L	0x1	lane4:
3:3	RWS_L	0x1	lane3:
2:2	RWS_L	0x1	lane2:
1:1	RWS_L	0x1	lane1:
0:0	RWS_L	0x1	lane0:

RX_CTLE_PEAK_0

This register controls the Continuous Time Linear Equalizer (CTLE) setting for the named receiver bundles on the selected port on the Intel QPI interface.

Type: CFG PortID:N/A Bus: 1 Device:8Function:4 Bus: 1 Device:9Function:4 Offset: 0x688			
Bit	Attr	Default	Description
19:16	RWS_L	0xd	bnd14: Refer to bit[3:0] definition.
15:12	RWS_L	0xd	bnd13: Refer to bit[3:0] definition.



Type: CFG PortID:N/A Bus: 1 Device:8Function:4 Bus: 1 Device:9Function:4 Offset: 0x688			
Bit	Attr	Default	Description
11:8	RWS_L	0xd	bndI2: Refer to bit[3:0] definition.
7:4	RWS_L	0xd	bndI1: Refer to bit[3:0] definition.
3:0	RWS_L	0xd	bndI0: Receive equalization control for CTLE. per bundle. 0001-1111 = CTLE peaking index 0000 = disabled. no peaking. note: the CSR controlling rx_ctle_peak has no effect in slow mode (QPI), during which the agent hardwires the value to dh. affects AFE puseclk: csclk affects AFE pin: csrx_ctle_peak_u<0-1>_b<0-9>csnnh[3:0]

RX_CTLE_PEAK_1

This register controls the Continuous Time Linear Equalizer (CTLE) setting for the named receiver bundles on the selected port on the Intel QPI interface.

Type: CFG PortID:N/A Bus: 1 Device:8Function:4 Bus: 1 Device:9Function:4 Offset: 0x68c			
Bit	Attr	Default	Description
19:16	RWS_L	0xd	bndI9: Refer to bit[3:0] definition.
15:12	RWS_L	0xd	bndI8: Refer to bit[3:0] definition.
11:8	RWS_L	0xd	bndI7: Refer to bit[3:0] definition.
7:4	RWS_L	0xd	bndI6: Refer to bit[3:0] definition.
3:0	RWS_L	0xd	bndI5: Receive equalization control for CTLE. per bundle. 0001-1111 = CTLE peaking index 0000 = disabled. no peaking. note: the CSR controlling rx_ctle_peak has no effect in slow mode (QPI), during which the agent hardwires the value to dh. affects AFE puseclk: csclk affects AFE pin: csrx_ctle_peak_u<0-1>_b<0-9>csnnh[3:0]



15. Datasheet Volume 2: Device 6-7 Function 0,1,3

Register Name	Offset	Size	Device 6 Function	Device 7 Function
rx_ctle_peak_gen2	0x694	32	0,1,3	0
rx_ctle_peak_gen3	0x698	32	1,3	0

rx_ctle_peak_gen2

This register controls the Continuous Time Linear Equalizer (CTLE) setting for the named receiver bundles on the selected port on the PCIe interface in Gen. 2 mode.

Type: CFG		PortID: N/A	
Bus: 0		Device: 6	
Offset: 0x694		Function: 0	
Bit	Attr	Default	Description
7:4	RWS_L	0x8	bndl1:
3:0	RWS_L	0x8	bndl0:

rx_ctle_peak_gen2

This register controls the Continuous Time Linear Equalizer (CTLE) setting for the named receiver bundles on the selected port on the PCIe interface in Gen. 2 mode.

Type: CFG		PortID: N/A	
Bus: 0		Device: 6	
Offset: 0x694		Function: 1	
Bit	Attr	Default	Description
15:12	RWS_L	0x8	bndl3:
11:8	RWS_L	0x8	bndl2:
7:4	RWS_L	0x8	bndl1:
3:0	RWS_L	0x8	bndl0:

rx_ctle_peak_gen3

This register controls the Continuous Time Linear Equalizer (CTLE) setting for the named receiver bundles on the selected port on the PCIe interface in Gen. 3 mode.

Type: CFG		PortID: N/A	
Bus: 0		Device: 6	
Offset: 0x698		Function: 1	
Bit	Attr	Default	Description
15:12	RWS_L	0x8	bndl3:
11:8	RWS_L	0x8	bndl2:
7:4	RWS_L	0x8	bndl1:
3:0	RWS_L	0x8	bndl0:



rx_ctle_peak_gen2

This register controls the Continuous Time Linear Equalizer (CTLE) setting for the named receiver bundles on the selected port on the PCIe interface in Gen. 2 mode.

Type:	CFG	PortID:	N/A
Bus:	0	Device:	6
Bus:	0	Device:	7
Function:	3		
Function:	0		
Offset:	0x694		
Bit	Attr	Default	Description
31:28	RWS_L	0x8	bndl7:
27:24	RWS_L	0x8	bndl6:
23:20	RWS_L	0x8	bndl5:
19:16	RWS_L	0x8	bndl4:
15:12	RWS_L	0x8	bndl3
11:8	RWS_L	0x8	bndl2
7:4	RWS_L	0x8	bndl1
3:0	RWS_L	0x8	bndl0

rx_ctle_peak_gen3

This register controls the Continuous Time Linear Equalizer (CTLE) setting for the named receiver bundles on the selected port on the PCIe interface in Gen. 3 mode.

Type:	CFG	PortID:	N/A
Bus:	0	Device:	6
Bus:	0	Device:	7
Function:	3		
Function:	0		
Offset:	0x698		
Bit	Attr	Default	Description
31:28	RWS_L	0xd	bndl7
27:24	RWS_L	0xd	bndl6
23:20	RWS_L	0xd	bndl5
19:16	RWS_L	0xd	bndl4
15:12	RWS_L	0xd	bndl3
11:8	RWS_L	0xd	bndl2
7:4	RWS_L	0xd	bndl1
3:0	RWS_L	0xd	bndl0



16. **Datasheet Volume 2: There is a typo on E5-1600/2600 (Section 3.2.5.48 LNKCAP: PCI Express Link Capabilities)**

Incorrect

11:10	RW-O	11b	Active State Link PM Support This field indicates the level of active state power management supported on the given PCI Express port. 00: Disabled 01: Reserved 10: Reserved 11: L1 Supported
-------	------	-----	--

Correct

11:10	RW-O	11b	Active State Link PM Support This field indicates the level of active state power management supported on the given PCI Express port. 00: Disabled 01: Reserved 10: L1 Supported 11: Reserved
-------	------	-----	--

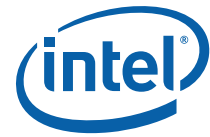

Mixed Processors Within DP Platforms

Mixed Processor Consistency Requirements

Intel supports dual processor (DP) configurations consisting of processors:

1. From the same power rating.
2. That support the same maximum Intel® QuickPath Interconnect (Intel® QPI) and DDR3 memory speeds.
3. That share symmetry across physical packages with respect to the number of logical processors per package, number of cores per package, number of Intel QPI Interfaces, and cache topology.
4. That have identical Extended Family, Extended Model, Processor Type, Family Code and Model Number as indicated by the function 1 of the CPUID instruction.

Note: Processors must operate with the same Intel QPI, DDR3 memory and core frequency.

While Intel does nothing to prevent processors from operating together, some combinations may not be supported due to limited validation, which may result in uncharacterized errata. Coupling this fact with the large number of Intel Xeon processor E5 series attributes, the following population rules and stepping matrix have been developed to clearly define supported configurations.

1. Processors must be of the same power rating. For example, mixing of 95W Thermal Design Power (TDP) processors is supported. Mixing of dissimilar TDPs in the same platform is not supported (for example, 95W with 130W, and so forth).
2. Processors must operate at the same core frequency. Note: Processors within the same power-optimization segment supporting different maximum core frequencies (for example, a 2.93 GHz / 95 W and 2.66 GHz / 95W) can be operated within a system. However, both must operate at the highest frequency rating commonly supported. Mixing components operating at different internal clock frequencies is not supported and will not be validated by Intel.
3. Processors must share symmetry across physical packages with respect to the number of logical processors per package, number of Intel QPI Interfaces, and cache topology.
4. Mixing dissimilar steppings is only supported with processors that have identical Extended Family, Extended Model, Processor type, Family Code and Model Number as indicated by the function 1 of the CPUID instruction. Mixing processors of different steppings but the same model (as per CPUID instruction) is supported. Details regarding the CPUID instruction are provided in the *AP-487, Intel® Processor Identification and the CPUID Instruction* application note and *Intel® 64 and IA-32 Architectures Software Developer's Manual, Volume 2A*.
5. After AND'ing the feature flag and extended feature flag from the installed processors, any processor whose set of feature flags exactly matches the AND'ed feature flags can be selected by the BIOS as the BSP. If no processor exactly matches the AND'ed feature flag values, then the processors with the numerically lower CPUID should be selected as the BSP.
6. Intel requires that the processor microcode update be loaded on each processor operating within the system. Any processor that does not have the proper microcode update loaded is considered by Intel to be operating out of specification.



7. The workarounds identified in this, and subsequent specification updates, must properly applied to each processor in the system. Certain errata are specific to the multiprocessor environment. Errata for all processor steppings will affect system performance if not properly worked around.
8. Customers are fully responsible for the validation of their system configurations.

Mixed Steppings

Mixing processors of different steppings but the same model (as per CPUID instruction) is supported provided there is no more than one stepping delta between the processors, for example, S and S+1.

S and S+1 is defined as mixing of two CPU steppings in the same platform where one CPU is S (stepping) = CPUID.(EAX=01h):EAX[3:0], and the other is S+1 = CPUID.(EAX=01h):EAX[3:0]+1. The stepping ID is found in EAX[3:0] after executing the CPUID instruction with Function 01h.