

64 MBit Synchronous DRAM

Advanced Information

- High Performance:

	-8	-10	Units
fCK	125	100	MHz
tCK3	8	10	ns
tAC3	7	8	ns
tAC2	7	9	ns

- Single Pulsed $\overline{\text{RAS}}$ Interface
- Fully Synchronous to Positive Clock Edge
- 0 to 70 °C operating temperature
- Four Banks controlled by BA0 & BA1
- Programmable $\overline{\text{CAS}}$ Latency: 2, 3, 4
- Programmable Wrap Sequence: Sequential or Interleave
- Programmable Burst Length:
 - 1, 2, 4, 8 and full page for Sequential type
 - 1, 2, 4, 8 for Interleave Type
- Multiple Burst Read with Single Write Operation
- Automatic and Controlled Precharge Command
- Data Mask for Read / Write control (x4, x8)
- Data Mask for byte control (x16)
- Auto Refresh (CBR) and Self Refresh
- Suspend Mode and Power Down Mode
- 4096 refresh cycles / 64 ms
- Random Column Address every CLK (1-N Rule)
- Single 3.3V +/- 0.3V Power Supply
- LVTTTL and SSTL_3 (Class II) Interface versions
- Plastic Packages:
 - P-TSOPII-54 400mil width (x4, x8, x16)

The HYB39S6440x/80x/16xT are four bank Synchronous DRAM's organized as 4 banks x 4MBit x4, 4 banks x 2MBit x8 and 4 banks x 1Mbit x16 respectively. These synchronous devices achieve high speed data transfer rates by employing a chip architecture that prefetches multiple bits and then synchronizes the output data to a system clock. The chip is fabricated with SIEMENS' advanced 64MBit DRAM process technology.

The device is designed to comply with all JEDEC standards set for synchronous DRAM products, both electrically and mechanically. All of the control, address, data input and output circuits are synchronized with the positive edge of an externally supplied clock.

Operating the four memory banks in an interleave fashion allows random access operation to occur at higher rate than is possible with standard DRAMs. A sequential and gapless data rate is possible depending on burst length, $\overline{\text{CAS}}$ latency and speed grade of the device.

Auto Refresh (CBR) and Self Refresh operation are supported. These devices operates with a single 3.3V +/- 0.3V power supply and are available in TSOPII packages.

Ordering Information

Type	Ordering Code	Package	Description
LVTTL-version:			
HYB 39S64400T-80		P-TSOP-54-2 (400mil)	125MHz 4B x 4M x 4 SDRAM
HYB 39S64400T-10		P-TSOP-54-2 (400mil)	100MHz 4B x 4M x 4 SDRAM
HYB 39S64800T-80		P-TSOP-54-2 (400mil)	125MHz 4B x 2M x 8 SDRAM
HYB 39S64800T-10		P-TSOP-54-2 (400mil)	100MHz 4B x 2M x 8 SDRAM
HYB 39S64160T-80		P-TSOP-54-2 (400mil)	125MHz 4B x 1M x 16 SDRAM
HYB 39S64160T-10		P-TSOP-54-2 (400mil)	100MHz 4B x 1M x 16 SDRAM
SSTL-version:			
HYB 39S64402T-80		P-TSOP-54-2 (400mil)	125 MHz 4B x 4M x 4 SDRAM
HYB 39S64402T-10		P-TSOP-54-2 (400mil)	100 MHz 4B x 4M x 4 SDRAM
HYB 39S64802T-80		P-TSOP-54-2 (400mil)	125 MHz 4B x 2M x 8 SDRAM
HYB 39S64802T-10		P-TSOP-54-2 (400mil)	100 MHz 4B x 2M x 8 SDRAM
HYB 39S64162T-80		P-TSOP-54-2 (400mil)	125 MHz 4B x 1M x 16 SDRAM
HYB 39S64162T-10		P-TSOP-54-2 (400mil)	100 MHz 4B x 1M x 16 SDRAM

Pin Description and Pinouts:

CLK	Clock Input	DQ	Data Input /Output
CKE	Clock Enable	DQM, LDQM, UDQM	Data Mask
\overline{CS}	Chip Select	Vdd	Power (+3.3V)
\overline{RAS}	Row Address Strobe	Vss	Ground
\overline{CAS}	Column Address Strobe	Vddq	Power for DQ's (+ 3.3V)
\overline{WE}	Write Enable	Vssq	Ground for DQ's
A0-A11	Address Inputs	NC	not connected
BA0, BA1	Bank Select	Vref	Reference Voltage (SSTL version only)

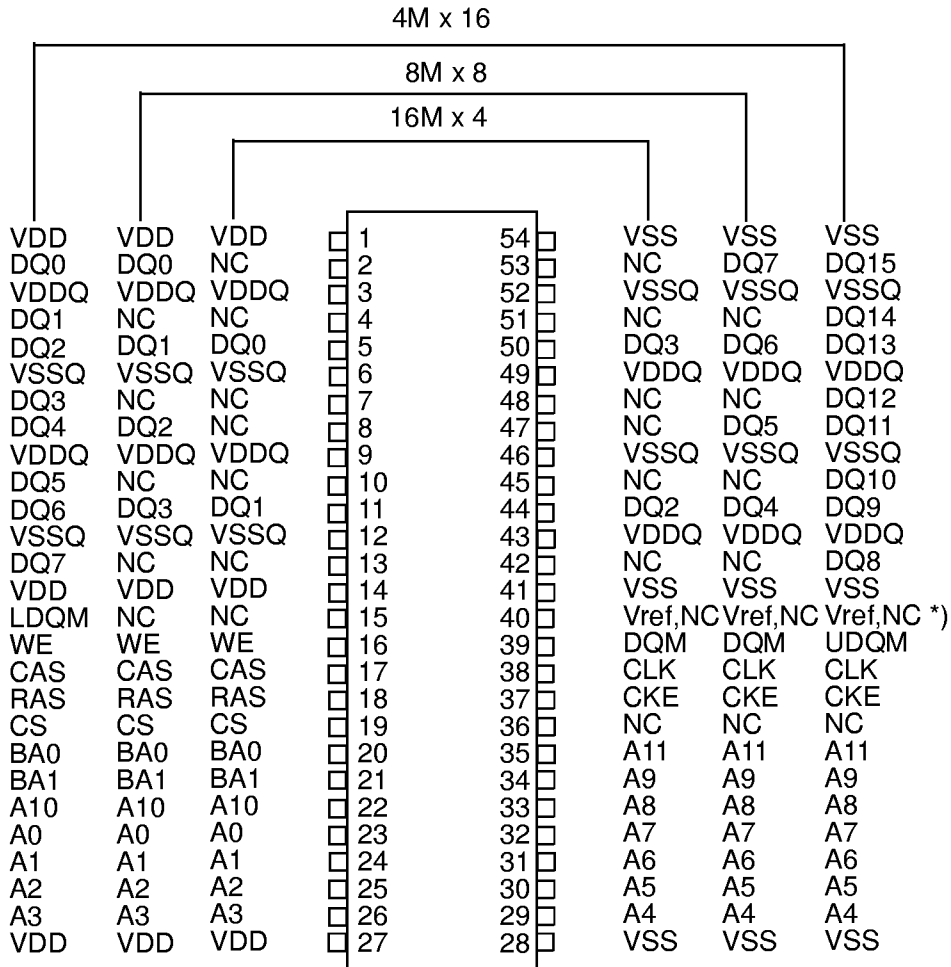

TSOPII-54 (10.16 mm x 22.22 mm, 0.8 mm pitch)

*) This pin is NC for LV-TTL and Vref for SSTL versions

Pinout for x4, x8 & x16 organised 64M-DRAMs

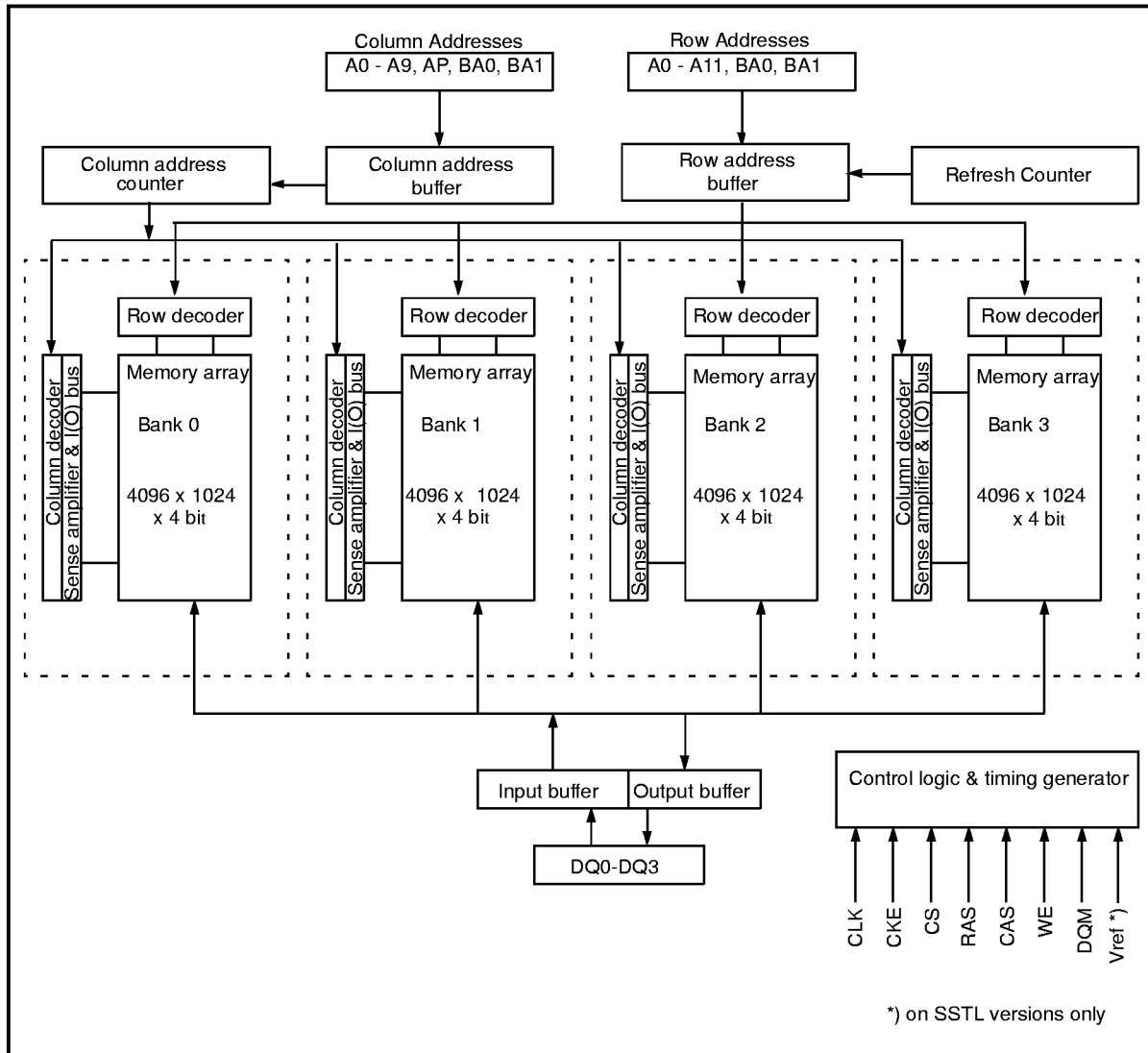

Block Diagram for 4 bank x 4M x 4 SDRAM

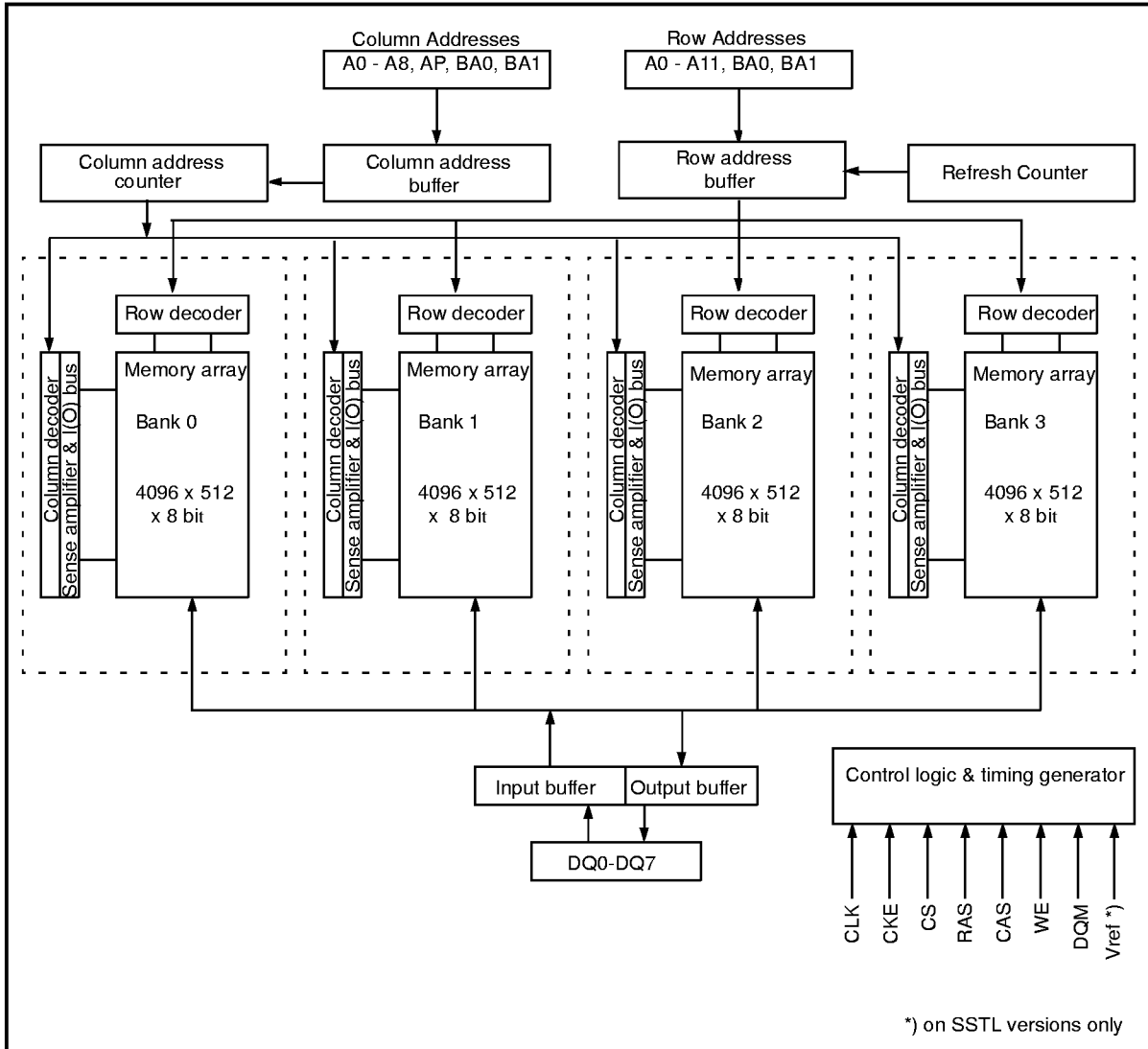

Block Diagram for 4 banks x 2M x 8 SDRAM

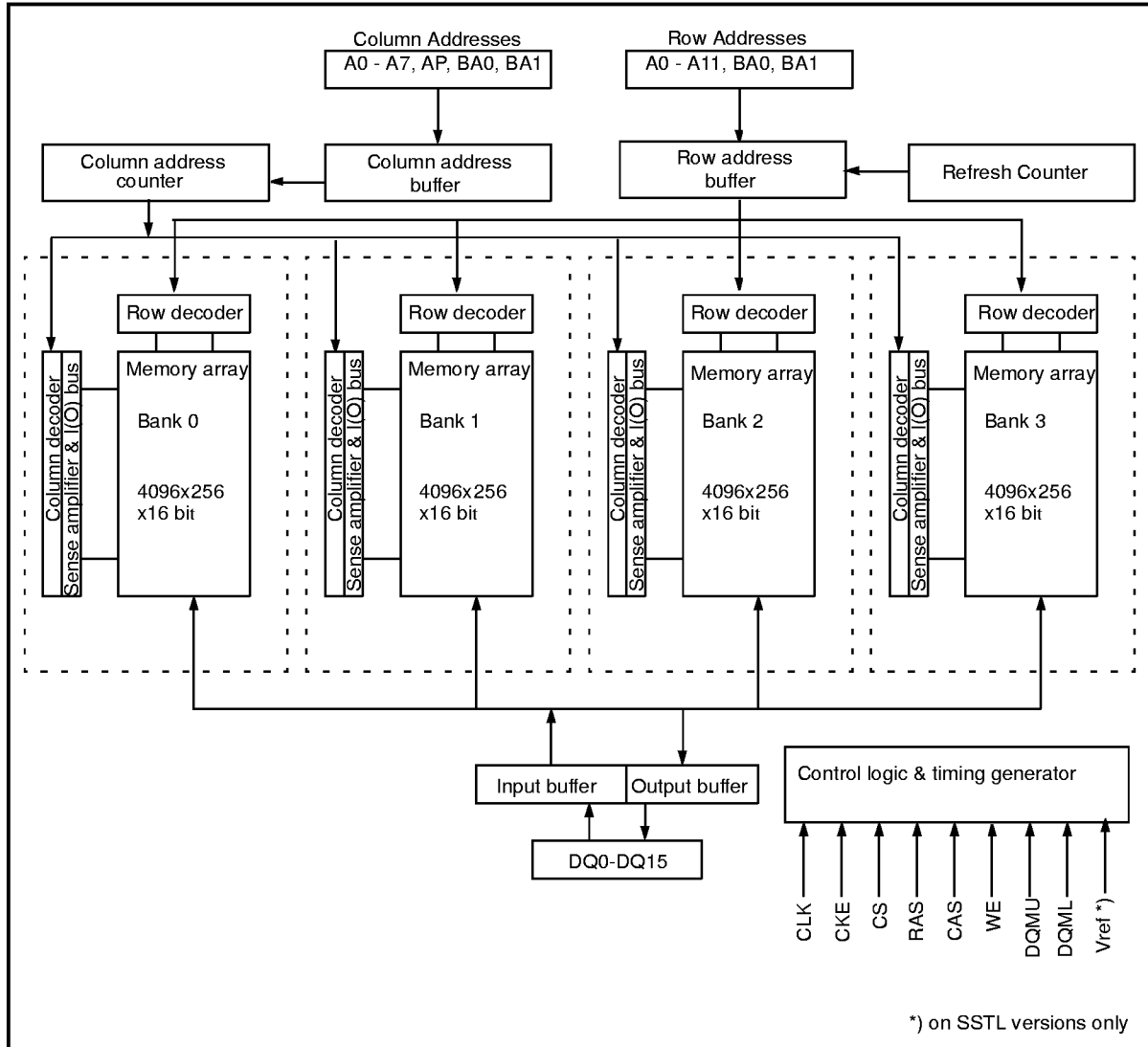

Block Diagram for 4 banks x 1M x16 SDRAM

Signal Pin Description

Pin	Type	Signal	Polarity	Function
CLK	Input	Pulse	Positive Edge	The system clock input. All of the SDRAM inputs are sampled on the rising edge of the clock.
CKE	Input	Level	Active High	Activates the CLK signal when high and deactivates the CLK signal when low, thereby initiates either the Power Down mode, Suspend mode, or the Self Refresh mode.
\overline{CS}	Input	Pulse	Active Low	\overline{CS} enables the command decoder when low and disables the command decoder when high. When the command decoder is disabled, new commands are ignored but previous operations continue.
\overline{RAS} , \overline{CAS} , \overline{WE}	Input	Pulse	Active Low	When sampled at the positive rising edge of the clock, \overline{CAS} , \overline{RAS} , and \overline{WE} define the command to be executed by the SDRAM.
A0 - A11	Input	Level	—	<p>During a Bank Activate command cycle, A0-A11 defines the row address (RA0-RA11) when sampled at the rising clock edge.</p> <p>During a Read or Write command cycle, A0-An defines the column address (CA0-CAn) when sampled at the rising clock edge. CAn depends from the SDRAM organisation:</p> <p style="margin-left: 40px;">16M x 4 SDRAM CAn = CA9 (Page Length = 1024 bits)</p> <p style="margin-left: 40px;">8M x 8 SDRAM CAn = CA8 (Page Length = 512 bits)</p> <p style="margin-left: 40px;">4M x 16 SDRAM CAn = CA7 (Page Length = 256 bits)</p> <p>In addition to the column address, A10(=AP) is used to invoke autoprecharge operation at the end of the burst read or write cycle. If A10 is high, autoprecharge is selected and BA0, BA1 defines the bank to be precharged. If A10 is low, autoprecharge is disabled.</p> <p>During a Precharge command cycle, A10 (=AP) is used in conjunction with BA0 and BA1 to control which bank(s) to precharge. If A10 is high, all four banks will be precharged regardless of the state of BA0 and BA1. If A10 is low, then BA0 and BA1 are used to define which bank to precharge.</p>
BA0,BA1	Input	Level	—	Bank Select (BS) Inputs. Selects which bank is to be active.
DQx	Input Output	Level	—	Data Input/Output pins operate in the same manner as on conventional DRAMs.
DQM LDQM UDQM	Input	Pulse	Active High	<p>The Data Input/Output mask places the DQ buffers in a high impedance state when sampled high. In Read mode, DQM has a latency of two clock cycles and controls the output buffers like an output enable. In Write mode, DQM has a latency of zero and operates as a word mask by allowing input data to be written if it is low but blocks the write operation if DQM is high.</p> <p>One DQM input is present in x4 and x8 SDRAMs, LDQM and UDQM controls the lower and upper bytes in x16 SDRAMs.</p>
VDD,VSS	Supply			Power and ground for the input buffers and the core logic.
VDDQ VSSQ	Supply	—	—	Isolated power supply and ground for the output buffers to provide improved noise immunity.
Vref	Input	Level	—	Reference voltage for SDRAM versions supporting SSTL interface

Operation Definition

All of SDRAM operations are defined by states of control signals \overline{CS} , \overline{RAS} , \overline{CAS} , \overline{WE} , and DQM at the positive edge of the clock. The following list shows the truth table for the operation commands.

Operation	Device State	CKE n-1	CKE n	\overline{CS}	\overline{RAS}	\overline{CAS}	\overline{WE}	DM	A0-9 A11	A10	BS0 BS1
Row Activate (ACT)	Idle ³	H	X	L	L	H	H	X	V	V	V
Read (RD)	Active ³	H	X	L	H	L	H	X	V	L	V
Read w/ Autoprecharge (RDA)	Active ³	H	X	L	H	L	H	X	V	H	V
Write (WR)	Active ³	H	X	L	H	L	L	X	V	L	V
Write w/ Autoprecharge (WRA)	Active ³	H	X	L	L	H	L	X	V	H	V
Row Precharge (PRE)	Any	H	X	L	L	H	L	X	X	L	V
Precharge All (PREAL)	Any	H	X	L	L	H	L	X	X	H	X
Mode Register Set (MRS)	Idle	H	X	L	L	L	L	X	V	V	V
No Operation (NOP)	Any	H	X	L	H	H	H	X	X	X	X
Device Deselect (INHBT)	Any	H	X	H	X	X	X	X	X	X	X
Auto Refresh (REF)	Idle	H	H	L	L	L	H	X	X	X	X
Self Refresh Entry (SREF-EN)	Idle	H	L	L	L	L	H	X	X	X	X
Self Refresh Exit (SREF-EX)	Idle (Self Refr.)	L	H	H	X	X	X	X	X	X	X
				L	H	H	X				
Power Down Entry (PDN-EN)	Idle Active ⁵	H	H	H	X	X	X	X	X	X	X
				L	H	H	X				
Power Down Exit (PDN-EX)	Any (Power Down)	L	H	H	X	X	X	X	X	X	X
				L	H	H	L				
Data Write/Output Enable	Active	H	X	X	X	X	X	L	X	X	X
Data Write/Output Disable	Active	H	X	X	X	X	X	H	X	X	X

Note:

1. V = Valid, x = Don't Care, L = Low Level, H = High Level
2. CKEn signal is input level when commands are provided, CKEn-1 signal is input level one clock before the commands are provided.
3. This is the state of the banks designated by BS0, BS1 signals.
4. Device state is Full Page Burst operation
5. Power Down Mode can not entry in the burst cycle. When this command assert in the burst mode cycle device is clock suspend mode.

Address Input for Mode Set (Mode Register Operation)

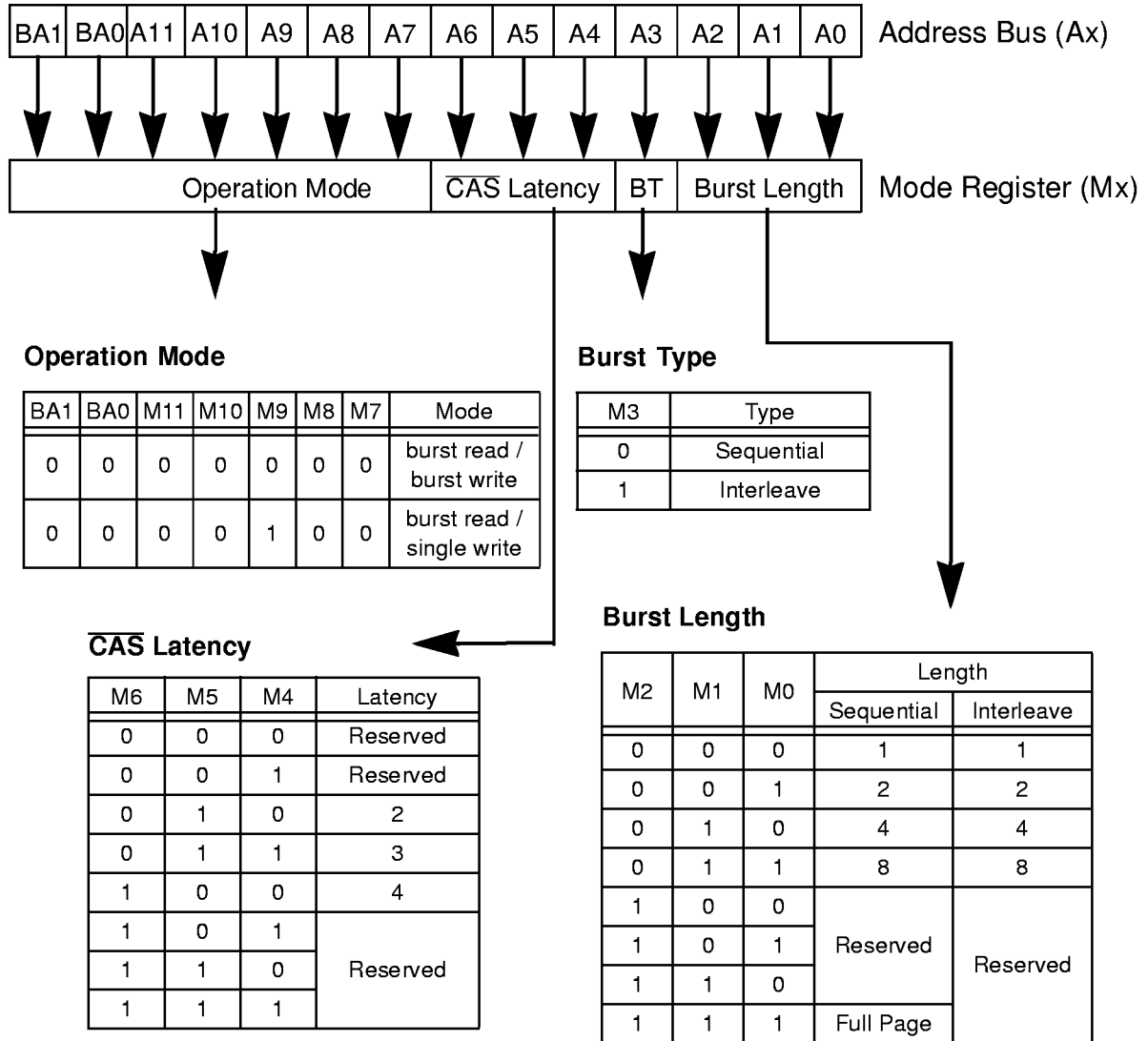

Power On and Initialization

The default power on state of the mode register is supplier specific and may be undefined. The following power on and initialization sequence guarantees the device is preconditioned to each users specific needs. Like a conventional DRAM, the Synchronous DRAM must be powered up and initialized in a predefined manner. During power on, all VDD and VDDQ pins must be built up simultaneously to the specified voltage when the input signals are held in the "NOP" state. The power on voltage must not exceed $VDD+0.3V$ on any of the input pins or VDD supplies. The CLK signal must be started at the same time. After power on, an initial pause of 200 μs is required followed by a precharge of both banks using the precharge command. To prevent data contention on the DQ bus during power on, it is required that the DQM and CKE pins be held high during the initial pause period. Once all banks have been precharged, the Mode Register Set Command must be issued to initialize the Mode Register. A minimum of eight Auto Refresh cycles (CBR) are also required. These may be done before or after programming the Mode Register. Failure to follow these steps may lead to unpredictable start-up modes.

Programming the Mode Register

The Mode register designates the operation mode at the read or write cycle. This register is divided into 4 fields. A Burst Length Field to set the length of the burst, an Addressing Selection bit to program the column access sequence in a burst cycle (interleaved or sequential), a CAS Latency Field to set the access time at clock cycle and a Operation mode field to differentiate between normal operation (Burst read and burst Write) and a special Burst Read and Single Write mode. The mode set operation must be done before any activate command after the initial power up. Any content of the mode register can be altered by re-executing the mode set command. All banks must be in precharged state and CKE must be high at least one clock before the mode set operation. After the mode register is set, a Standby or NOP command is required. Low signals of \overline{RAS} , \overline{CAS} , and \overline{WE} at the positive edge of the clock activate the mode set operation. Address input data at this timing defines parameters to be set as shown in the previous table.

Read and Write Operation

When \overline{RAS} is low and both \overline{CAS} and \overline{WE} are high at the positive edge of the clock, a RAS cycle starts. According to address data, a word line of the selected bank is activated and all of sense amplifiers associated to the wordline are set. A CAS cycle is triggered by setting \overline{RAS} high and \overline{CAS} low at a clock timing after a necessary delay, t_{RCD} , from the RAS timing. \overline{WE} is used to define either a read ($\overline{WE} = H$) or a write ($\overline{WE} = L$) at this stage.

SDRAM provides a wide variety of fast access modes. In a single CAS cycle, serial data read or write operations are allowed at up to a 143 MHz data rate. The numbers of serial data bits are the burst length programmed at the mode set operation, i.e., one of 1, 2, 4, 8 and full page. Column addresses are segmented by the burst length and serial data accesses are done within this boundary. The first column address to be accessed is supplied at the CAS timing and the subsequent addresses are generated automatically by the programmed burst length and its sequence. For example, in a burst length of 8 with interleave sequence, if the first address is '2', then the rest of the burst sequence is 3, 0, 1, 6, 7, 4, and 5.

Full page burst operation is only possible using the sequential burst type and page length is a function of the I/O organisation and column addressing. Full page burst operation do not self terminate once the burst length has been reached. In other words, unlike burst length of 2, 3 or 8, full page burst continues until it is terminated using another command.

Similar to the page mode of conventional DRAM's, burst read or write accesses on any column address are possible once the RAS cycle latches the sense amplifiers. The maximum tRAS or the refresh interval time limits the number of random column accesses. A new burst access can be done even before the previous burst ends. The interrupt operation at every clock cycle is supported. When the previous burst is interrupted, the remaining addresses are overridden by the new address with the full burst length. An interrupt which accompanies an operation change from a read to a write is possible by exploiting DQM to avoid bus contention.

When two or more banks are activated sequentially, interleaved bank read or write operations are possible. With the programmed burst length, alternate access and precharge operations on two or more banks can realize fast serial data access modes among many different pages. Once two or more banks are activated, column to column interleave operation can be done between different pages.

Burst Length and Sequence:

Burst Length	Starting Address (A2 A1 A0)	Sequential Burst Addressing (decimal)	Interleave Burst Addressing (decimal)
2	xx0	0, 1	0, 1
	xx1	1, 0	1, 0
4	x00	0, 1, 2, 3	0, 1, 2, 3
	x01	1, 2, 3, 0	1, 0, 3, 2
	x10	2, 3, 0, 1	2, 3, 0, 1
	x11	3, 0, 1, 2	3, 2, 1, 0
8	000	0 1 2 3 4 5 6 7	0 1 2 3 4 5 6 7
	001	1 2 3 4 5 6 7 0	1 0 3 2 5 4 7 6
	010	2 3 4 5 6 7 0 1	2 3 0 1 6 7 4 5
	011	3 4 5 6 7 0 1 2	3 2 1 0 7 6 5 4
	100	4 5 6 7 0 1 2 3	4 5 6 7 0 1 2 3
	101	5 6 7 0 1 2 3 4	5 4 7 6 1 0 3 2
	110	6 7 0 1 2 3 4 5	6 7 4 5 2 3 0 1
	111	7 0 1 2 3 4 5 6	7 6 5 4 3 2 1 0
Full Page	nnn	Cn, Cn+1, Cn+2,.....	not supported

Refresh Mode

SDRAM has two refresh modes, Auto Refresh and Self Refresh. Auto Refresh is similar to the $\overline{\text{CAS}}$ -before- $\overline{\text{RAS}}$ refresh of conventional DRAMs. All of banks must be precharged before applying any refresh mode. An on-chip address counter increments the word and the bank addresses and no bank information is required for both refresh modes.

The chip enters the Auto Refresh mode, when $\overline{\text{RAS}}$ and $\overline{\text{CAS}}$ are held low and CKE and $\overline{\text{WE}}$ are held high at a clock timing. The mode restores word line after the refresh and no external precharge command is necessary. A minimum tRC time is required between two automatic refreshes in a burst refresh mode. The same rule applies to any access command after the automatic refresh operation.

The chip has an on-chip timer and the Self Refresh mode is available. It enters the mode when \overline{RAS} , \overline{CAS} , and CKE are low and \overline{WE} is high at a clock timing. All of external control signals including the clock are disabled. Returning CKE to high enables the clock and initiates the refresh exit operation. After the exit command, at least one tRC delay is required prior to any access command.

DQM Function

DQM has two functions for data I/O read and write operations. During reads, when it turns to „high“ at a clock timing, data outputs are disabled and become high impedance after two clock delay (DQM Data Disable Latency t_{DQZ}). It also provides a data mask function for writes. When DQM is activated, the write operation at the next clock is prohibited (DQM Write Mask Latency t_{DQW} = zero clocks).

Suspend Mode

During normal access mode, CKE is held high enabling the clock. When CKE is low, it freezes the internal clock and extends data read and write operations. One clock delay is required for mode entry and exit (Clock Suspend Latency t_{CSL}).

Power Down

In order to reduce standby power consumption, a power down mode is available. All banks must be precharged and the necessary Precharge delay (trp) must occur before the SDRAM can enter the Power Down mode. Once the Power Down mode is initiated by holding CKE low, all of the receiver circuits except CLK and CKE are gated off. The Power Down mode does not perform any refresh operations, therefore the device can't remain in Power Down mode longer than the Refresh period (tref) of the device. Exit from this mode is performed by taking CKE „high“. One clock delay is required for mode entry and exit.

Auto Precharge

Two methods are available to precharge SDRAMs. In an automatic precharge mode, the CAS timing accepts one extra address, CA10, to determine whether the chip restores or not after the operation. If CA10 is high when a Read Command is issued, the **Read with Auto-Precharge** function is initiated. The SDRAM automatically enters the precharge operation one clock before the last data out for \overline{CAS} latencies 2, two clocks for \overline{CAS} latencies 3 and three clocks for CAS latencies 4. If CA10 is high when a Write Command is issued, the **Write with Auto-Precharge** function is initiated. The SDRAM automatically enters the precharge operation a time delay equal to t_{WR} (Write recovery time) after the last data in.

Precharge Command

There is also a separate precharge command available. When \overline{RAS} and \overline{WE} are low and \overline{CAS} is high at a clock timing, it triggers the precharge operation. Three address bits, BA0, BA1 and A10 are used to define banks as shown in the following list. The precharge command can be imposed one clock before the last data out for CAS latency = 2, two clocks before the last data out for CAS latency = 3 and three clocks before the last data out for CAS latency = 4. Writes require a time delay t_{wr} from the last data out to apply the precharge command.

Bank Selection by Address Bits :

A10	BA0	BA1	
0	0	0	Bank 0
0	0	1	Bank 1
0	1	0	Bank 2
0	1	1	Bank 3
1	x	x	all Banks

Burst Termination

Once a burst read or write operation has been initiated, there are several methods in which to terminate the burst operation prematurely. These methods include using another Read or Write Command to interrupt an existing burst operation, use a Precharge Command to interrupt a burst cycle and close the active bank, or using the Burst Stop Command to terminate the existing burst operation but leave the bank open for future Read or Write Commands to the same page of the active bank. When interrupting a burst with another Read or Write Command care must be taken to avoid DQ contention. The Burst Stop Command, however, has the fewest restrictions making it the easiest method to use when terminating a burst operation before it has been completed. If a Burst Stop command is issued during a burst write operation, then any residual data from the burst write cycle will be ignored. Data that is presented on the DQ pins before the Burst Stop Command is registered will be written to the memory.

Absolute Maximum Ratings

Operating temperature range	0 to + 70 °C
Storage temperature range.....	- 55 to + 150 °C
Input/output voltage	- 0.3 to V _{CC} +0.3 V
Power supply voltage VDD / VDDQ.....	- 0.3 to + 4.6 V
Power Dissipation.....	1 W
Data out current (short circuit)	50 mA

Note: Stresses above those listed under “Absolute Maximum Ratings” may cause permanent damage of the device. Exposure to absolute maximum rating conditions for extended periods may affect device reliability.

Recommended Operation and Characteristics for LV-TTL versions:

T_A = 0 to 70 °C; V_{SS} = 0 V; V_{DD}, V_{DDQ} = 3.3 V ± 0.3 V

Parameter	Symbol	Limit Values		Unit	Notes
		min.	max.		
Input high voltage	V _{IH}	2.0	V _{CC} +0.3	V	1, 2
Input low voltage	V _{IL}	- 0.3	0.8	V	1, 2
Output high voltage (I _{OUT} = - 2.0 mA)	V _{OH}	2.4	-	V	3
Output low voltage (I _{OUT} = 2.0 mA)	V _{OL}	-	0.4	V	3
Input leakage current, any input (0 V < V _{IN} < V _{DDQ} , all other inputs = 0 V)	I _{I(L)}	- 5	5	μA	
Output leakage current (DQ is disabled, 0 V < V _{OUT} < V _{CC})	I _{O(L)}	- 5	5	μA	

Notes:

- All voltages are referenced to VSS.
- V_{IH} may overshoot to V_{CC} + 2.0 V for pulse width of < 4ns with 3.3V. V_{IL} may undershoot to -2.0 V for pulse width < 4.0 ns with 3.3V. Pulse width measured at 50% points with amplitude measured peak to DC reference.

Capacitance

T_A = 0 to 70 °C; V_{DD} = 3.3 V ± 0.3 V, f = 1 MHz

Parameter	Symbol	max. Values	Unit
Input capacitance (CLK)	C _{I1}	6	pF
Input capacitance (A0-A11, BA0,BA1, \overline{RAS} , \overline{CAS} , \overline{WE} , \overline{CS} , CKE, DQM)	C _{I2}	4	pF
Input / Output capacitance (DQ)	C _{IO}	5	pF
Vref	C _{REF}	8	pF

Recommended Operation and Characteristics for SSTL-versions:

$T_A = 0$ to 70 °C; $V_{SS} = 0$ V;

Parameter	Symbol	Limit Values			Unit	Notes
		min.	typ.	max.		
Power Supply Voltage	Vcc	3.0	3.3	3.6	V	
Power Supply Voltage for I/O Buffer	Vccq	3.0	3.3	3.6	V	
Input Reference Voltage	Vref	1.3	1.5	1.7	V	5
Termination Voltage	Vtt	Vref-0.05	Vref	Vref+0.05		6
Input high voltage	V_{IH}	Vref + 0.2	–	Vccq+0.3	V	3
Input low voltage	V_{IL}	– 0.3	–	Vref + 0.2	V	4
Output high voltage ($I_{OUT} = -16$ mA)	V_{OH}	Vtt + 0.8	–	–	V	
Output low voltage ($I_{OUT} = 16$ mA)	V_{OL}	–	–	Vtt-0.8	V	
Input leakage current, any input (0 V < V_{IN} < 3.6 V, all other inputs = 0 V)	$I_{I(L)}$	– 5		5	μA	
Output leakage current (DQ is disabled, 0 V < V_{OUT} < V_{CC})	$I_{O(L)}$	– 5		5	μA	

Notes:

- $V_{ih(max)} = V_{ccq} + 1.2$ V for pulse width < 5 ns
- $V_{il(max)} = V_{ssq} - 1.2$ V for pulse width < 5 ns
- The value of Vref may be selected by the user to provide optimum noise margin in the system. Vref has to be in the range between $0.43 * V_{ccq}$ and $0.47 * V_{ccq}$ and is expected to track variations in Vccq.
- Vtt of transmitting device must track Vref of receiving device

Operating Currents ($T_A = 0$ to 70°C , $V_{CC} = 3.3\text{V} \pm 0.3\text{V}$)

(Recommended Operating Conditions unless otherwise noted)

Parameter & Test Condition		Symb.	-80	-10		Note
			max.			
OPERATING CURRENT trc=trcmin., tck=tckmin. Active-precharge command cycling, without burst operation	1 bank operation	ICC1	130	110	mA	7
PRECHARGE STANDBY CURRENT in Power Down Mode $\overline{CS} = V_{IH}(\text{min.})$, $CKE \leq V_{IL}(\text{max.})$	tck = min.	ICC2P	3	3	mA	7
	tck = Infinity	ICC2PS	2	2	mA	
PRECHARGE STANDBY CURRENT in Non-Power Down Mode $\overline{CS} = V_{IH}(\text{min.})$, $CKE \geq V_{IH}(\text{min.})$	tck = min.	ICC2	60	50	mA	7
	tck = Infinity	ICC2S	5	5	mA	
NO OPERATING CURRENT tck = min., $\overline{CS} = V_{IH}(\text{min.})$, active state (max. 4 banks)	$CKE \geq V_{IH}(\text{min.})$	ICC3	90	70	mA	
	$CKE \leq V_{IL}(\text{max.})$ (Power down mode)	ICC3P	8	8	mA	
BURST OPERATING CURRENT tck = min., Read/Write command cycling		ICC4	175	155	mA	7,8
AUTO REFRESH CURRENT tck = min., Auto Refresh command cycling		ICC5	150	130	mA	7
SELF REFRESH CURRENT Self Refresh Mode, $CKE = 0.2\text{V}$		ICC6	2	2	mA	

Notes:

- These parameters depend on the cycle rate and these values are measured by the cycle rate under theminimum value of tck and trc. Input signals are changed one time during tck.
- These parameter depend on output loading. Specified values are obtained with output open.

AC Characteristics 1)2)3)

$T_A = 0$ to 70 °C; $V_{SS} = 0$ V; $V_{CC} = 3.3$ V \pm 0.3 V, $t_T = 1$ ns

Parameter	Symbol	Limit Values				Unit
		-80		-10		
		min	max	min	max	

Clock and Clock Enable

Clock Cycle Time							
$\overline{\text{CAS}}$ Latency = 4	t_{CK}	8	–	10	–	ns	
$\overline{\text{CAS}}$ Latency = 3		8	–	10	–	ns	
$\overline{\text{CAS}}$ Latency = 2		12	–	15	–	ns	
Clock Frequency							
$\overline{\text{CAS}}$ Latency = 4	t_{CK}	–	125	–	100	MHz	
$\overline{\text{CAS}}$ Latency = 3		–	125	–	100	MHz	
$\overline{\text{CAS}}$ Latency = 2		–	83	–	66	MHz	
Access Time from Clock							
$\overline{\text{CAS}}$ Latency = 4	t_{AC}	–	7	–	8	ns	4
$\overline{\text{CAS}}$ Latency = 3		–	7	–	8	ns	
$\overline{\text{CAS}}$ Latency = 2		–	7	–	9	ns	
Clock High Pulse Width	t_{CH}	3	–	3	–	ns	
Clock Low Pulse Width	t_{CL}	3	–	3	–	ns	
Transition time	t_T	0.5	10	0.5	10	ns	

Setup and Hold Times

Command Setup Time	t_{CS}	2.5	–	3	–	ns	5
Address Setup Time	t_{AS}	2.5	–	3	–	ns	5
Data In Setup Time	t_{DS}	2.5	–	3	–	ns	5
CKE Setup Time	t_{CKS}	2.5	–	3	–	ns	5
CKE Setup Time (Self Refresh exit)	t_{CKSR}	8	–	8	–	ns	
Command Hold Time	t_{CH}	1	–	1	–	ns	5
Address Hold Time	t_{AH}	1	–	1	–	ns	5
Data In Hold Time	t_{DH}	1	–	1	–	ns	5
CKE Hold Time	t_{CKH}	1	–	1	–	ns	5

Parameter	Symbol	Limit Values				Unit
		-80		-10		
		min	max	min	max	

Common Parameters

Row to Column Delay Time	t_{RCD}	24	–	30	–	ns	6
Row Active Time	t_{RAS}	48	100k	60	100k	ns	6
Row Cycle Time	t_{RC}	72	–	90	–	ns	6
Row Precharge Time	t_{RP}	24	–	30	–	ns	6
Activate(a) to Activate(b) Command period	t_{RRD}	20	–	20	–	ns	6
$\overline{CAS}(a)$ to $\overline{CAS}(b)$ Command period	t_{CCD}	1	–	1	–	CLK	
Mode Register Set-up time	t_{RSC}	16	–	20	–	ns	
Power Down Mode Entry Time	t_{SB}	0	8	0	10	ns	

Refresh Cycle

Refresh Period (4096 cycles)	t_{REF}	–	64	–	64	ms	
Self Refresh Exit Time	t_{SREX}	2 CLK + t_{RC}					7

Read Cycle

Data Out Hold Time	t_{OH}	3	–	3	–	ns	
Data Out to Low Impedance Time	t_{LZ}	0	–	0	–	ns	
Data Out to High Impedance Time	t_{HZ}	3	8	3	10	ns	8
DQM Data Out Disable Latency	t_{DQZ}	2	–	2	–	CLK	

Write Cycle

Write Recovery Time	t_{WR}						
\overline{CAS} Latency = 4		8	–	10	–	ns	
\overline{CAS} Latency = 3		8	–	10	–	ns	
\overline{CAS} Latency = 2		12	–	15	–	ns	
DQM Write Mask Latency	t_{DQW}	0	–	0	–	CLK	

Clock Frequency and Latency Table:

Parameter			Speed Sort						Unit
			-80			-10			
Clock Frequency	max.	t_{CK}	125		83	100		66	MHz
Clock Cycle Time	min.	t_{CK}	8	8	12	10	10	15	ns
CAS Latency	min.	t_{AA}	4	3	2	4	3	2	CLK
Row to Column Delay	min.	t_{RCD}	3		2	3		2	CLK
RAS Latency	min.	t_{RL}	7	6	4	7	6	4	CLK
Row Active Time	min.	t_{RAS}	6		4	6		4	CLK
Row Precharge Time	min.	t_{RP}	3		2	3		2	CLK
Row Cycle Time	min.	t_{RC}	9		6	9		6	CLK
Write Recovery	min.	t_{WR}	1			1			CLK
Last Data In to Active/Refr.	min.	t_{WR+} t_{RP}	4		3	4		3	CLK
Activate(a) to Activate(b)	min.	t_{RRD}	3		2	2		2	CLK
CAS(a) to CAS(b)	min.	t_{CCD}	1			1			CLK
Write Latency	fixed	t_{WL}	0			0			CLK
DQM Write Mask Latency	fixed	t_{DQW}	0			0			CLK
DQM Data Out Disable Latency	fixed	t_{DQZ}	2			2			CLK
Clock Suspend Latency	fixed	t_{CSL}	1			1			CLK

Notes for AC Parameters:

1. For proper power-up see the operation section of this data sheet.
2. AC timing tests for LV-TTL versions have $V_{il} = 0.4\text{ V}$ and $V_{ih} = 2.4\text{ V}$ with the timing referenced to the 1.4 V crossover point. The transition time is measured between V_{ih} and V_{il} . All AC measurements assume $t_T=1\text{ ns}$ with the AC output load circuit shown in fig.1..

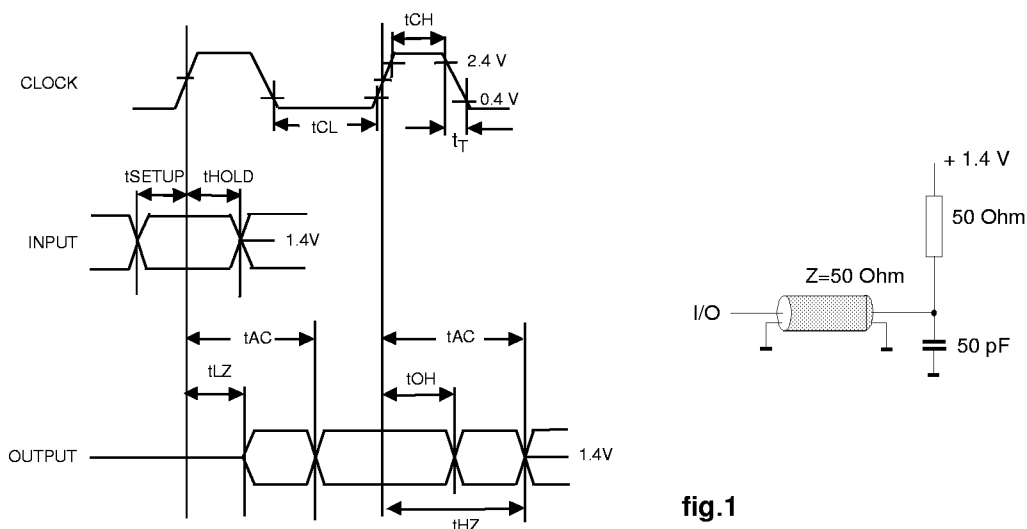

fig.1

3. AC timing test conditions for SSTL_3 versions:

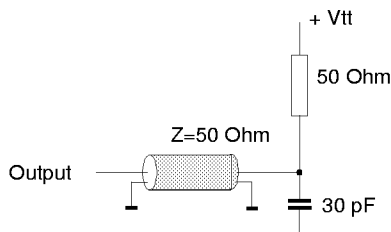

fig.1

Termination Voltage	$0.45 \times V_{ccq}$
Reverence Level of Output Signals (Vref)	$0.45 \times V_{ccq}$
Output Load	see fig. 1
Transition Time (Rise and Fall) of Input Signals	1 ns
Reference Level of Input Signals (Vref)	$0.45 \times V_{ccq}$

4. If clock rising time is longer than 1 ns, a time $(t_T/2 - 0.5)\text{ ns}$ has to be added to this parameter.
5. If t_T is longer than 1 ns, a time $(t_T - 1)\text{ ns}$ has to be added to this parameter.
6. These parameter account for the number of clock cycle and depend on the operating frequency of the clock, as follows:
the number of clock cycle = specified value of timing period (counted in fractions as a whole number)
 Self Refresh Exit is a synchronous operation and begins on the 2nd positive clock edge after CKE returns high. Self Refresh Exit is not complete until a time period equal to t_{RC} is satisfied once the Self Refresh Exit command is registered.
7. Referenced to the time which the output achieves the open circuit condition, not to output voltage levels

Package Outlines

**Plastic Package P-TSOPII-54 (400mil, 0.8mm lead pitch)
Thin small outline package, SMD**

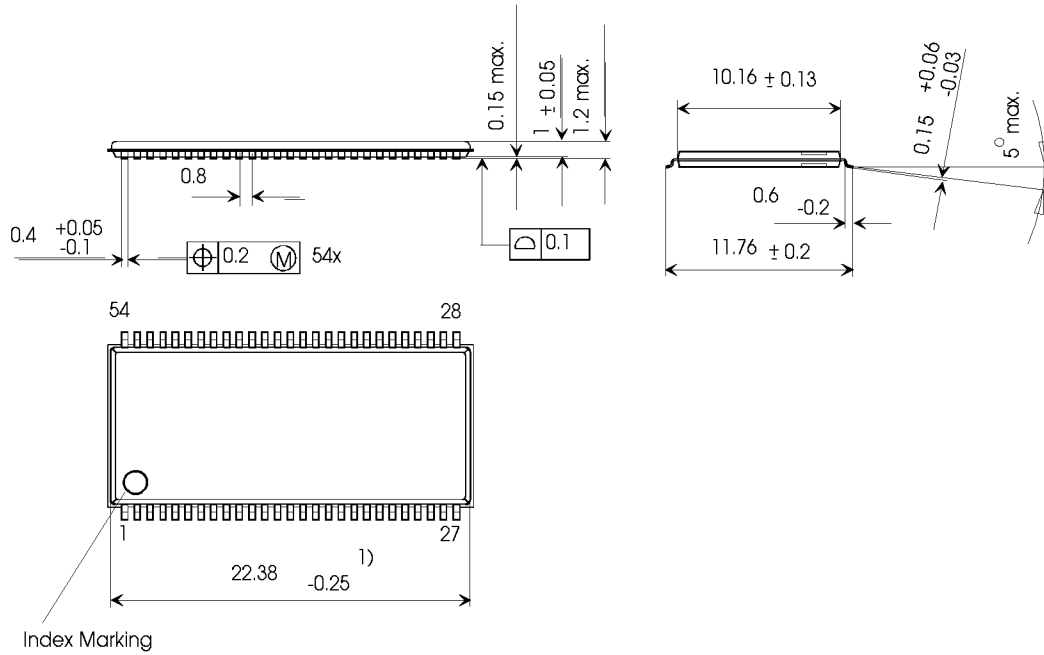

1) Does not include plastic or metal protrusion of 0.15 max. per side

TSOPII-54 (400 mil)
TSOP54-2.DRW