

MICRO LOW-PROFILE 0.185" MAXIMUM HEIGHT MIL-STD-1553 SMT TRANSFORMERS

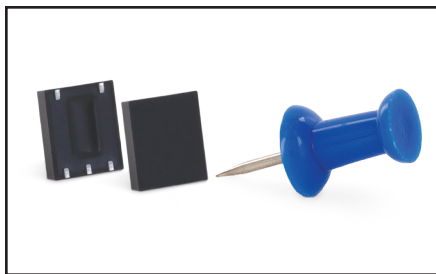

FEATURES

- *Smallest Footprint Available*
- *Low Profile*
- *Surface Mount*
- Tape and Reel Available
- *Withstands Conventional IR/Convection Reflow Process*
- *-55°C to +130°C Operating Temperature Range*
- *Built and Tested to MIL-PRF-21038 and MIL-STD-202*
- *Available RoHS Compliant*

DESCRIPTION AND APPLICATIONS

The military data bus specification, MIL-STD-1553, brought about the need for versatile pulse transformers that meet all the electrical requirements of Manchester II serial bi-phase data transmission. The ULP-2000 series of transformers provide the turns ratio configurations, component isolation, and common mode rejection ratio characteristics necessary for MIL-STD-1553A and B compliance.

The step-up and step-down ratios that are available with the ULP-2000 series complement DDC's entire MIL-STD-1553 product line. These transformers are low-profile and provide a 46% reduction in board space compared to MLP series, and 32% weight reduction compared to MLPs. They are encapsulated and meet the performance requirements of MIL-PRF-21038. Sinusoidal or trapezoidal waveforms are accurately processed, making the ULP-2000 series of transformers an excellent choice for any MIL-STD-1553A or B application.

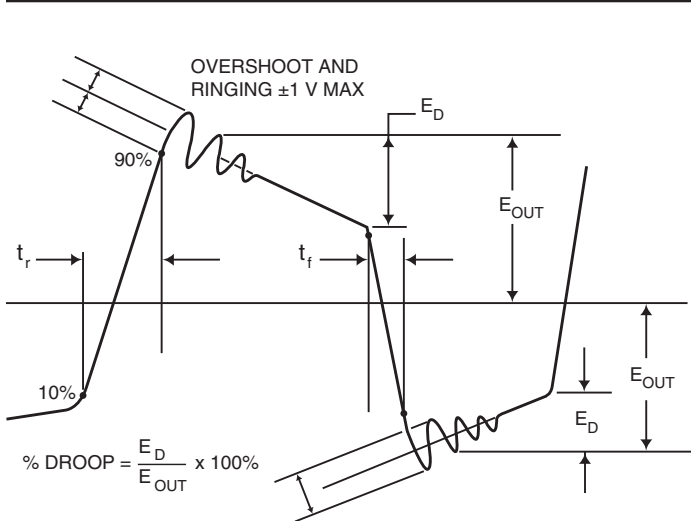

FIGURE 1. WAVEFORM INTEGRITY

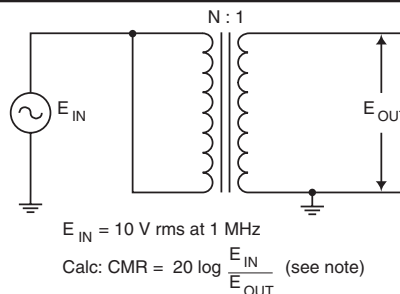
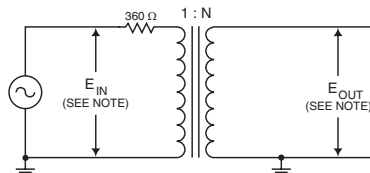

FIGURE 2. CIRCUIT FOR COMMON MODE REJECTION



E_{IN} (5, 12, 15 volt) = 250 kHz square wave, 27.0 volts peak to peak with a rise and fall time of 90ns \pm 5 ns.

E_{IN} (3.3 volt) = 250 kHz square wave, 7.0 volts peak to peak with a rise and fall time of 90ns \pm 5 ns.

Calc: Droop = $\frac{E_D}{E_{OUT}} \times 100\%$ (see figure 1 for E_D)

FIGURE 3. CIRCUIT FOR WAVEFORM INTEGRITY

Note: Input to be applied and output to be measured for all dash numbers are as shown. N represents highest turns winding in each test.

TABLE 1. GENERAL SPECIFICATIONS

PARAMETER	UNIT	VALUE	REMARKS
Case	—	—	Flame Resistant, Diallyl Phthalate
Terminals	—	—	C11000 ETP Copper, Sn60Pb40 Plated over nickel underplating
Weight	Oz (gm)	0.03 (0.85) max.	
Terminal Strength	lbs	1/2	1/2 pounds applied force, Method 211, MIL-STD-202, Test Condition A
Dielectric Withstanding Voltage	Vrms	100	Method 301, MIL-STD-202
Life (expectancy "X")	Hrs	10,000 min.	In accordance with MIL-PRF-21038
Insulation Resistance	MΩ	1,000 min.	At 250 Vdc using Method 302, Test Condition B, MIL-STD-202
Pulse Width (Output Pulse)	μs	2	Tested using FIGURE 3 with resulting FIGURE 1 waveform.
Overshoot	V	± 1 max.	Tested using FIGURE 3 with resulting FIGURE 1 waveform.
Rise Time (of Output Pulse)	ns	—	Tested using FIGURE 3 with resulting FIGURE 1 waveform. See ELECTRICAL CHARACTERISTICS TABLE.
Common Mode Rejection	dB	45	Tested using FIGURE 2.
Operating Temperature Range	°C	-55° to +130°	
Drop	%	≤ 20	Tested using FIGURE 3 with resulting FIGURE 1 waveform.
DC Resistance	Ω	—	See ELECTRICAL CHARACTERISTICS TABLE
Input Impedance	Ω	—	See ELECTRICAL CHARACTERISTICS TABLE.

CONFIGURATION

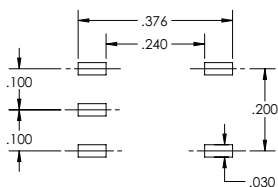
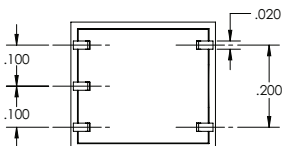
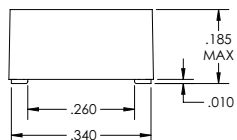
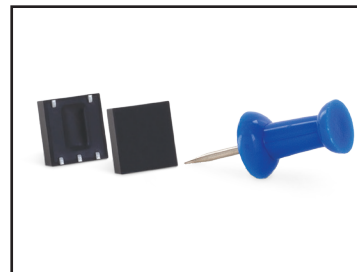
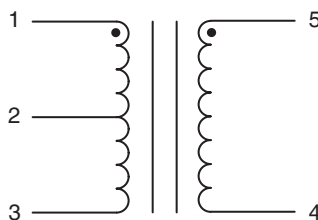
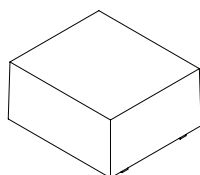
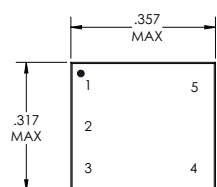

SUGGESTED FOOTPRINT

TABLE 2. ELECTRICAL CHARACTERISTICS

BETA P/N	TURNS RATIO	PRIMARY	SECONDARY	DC RESISTANCE Ω (MAX)	OUTPUT RISE TIME (MAX)	IMPEDANCE Ω (MIN)	
						75KHZ TO 249KHZ	250KHZ TO 1 MHZ
ULP-2033	1:3.75 ±3%	1-3	5-4	(1-3) 0.29 (5-4) 3.00	250 ns	(5-4) 4,000	(5-4) 4,000
ULP-2005	1:2.50 ±3%	1-3	5-4	(1-3) 1.5 (5-4) 3.5	250 ns	(5-4) 3,000	(5-4) 4,000
ULP-2015	1.41:1 ±3%	1-3	5-4	(1-3) 2.7 (5-4) 2.2	150 ns	(1-3) 5,000	(1-3) 7,200
ULP-2016	1:3.00 ±3%	1-3	5-4	(1-3) 0.35 (5-4) 3.50	250 ns	(5-4) 4,000	(5-4) 4,000
ULP-2030	1:2.65 ±3%	1-3	5-4	(1-3) 0.29 (5-4) 1.60	250 ns	(5-4) 2,000	(5-4) 4,000
ULP-2233	1:2.70 ±3%	1-3	5-4	(1-3) 0.25 (5-4) 2.00	250 ns	(5-4) 2,000	(5-4) 3,000
ULP-2205	1:1.79 ±3%	1-3	5-4	(1-3) 1.5 (5-4) 2.0	150 ns	(5-4) 2,000	(5-4) 4,000
ULP-2215	2.00:1 ±3%	1-3	5-4	(1-3) 2.6 (5-4) 1.3	150 ns	(1-3) 5,000	(1-3) 7,200
ULP-2216	1:2.15 ±3%	1-3	5-4	(1-3) 0.35 (5-4) 2.50	250 ns	(5-4) 2,000	(5-4) 4,000
ULP-2230	1:2.07 ±3%	1-3	5-4	(1-3) 0.29 (5-4) 1.20	250 ns	(5-4) 2,000	(5-4) 4,000

- Note:
- 1) These transformers have been classified as Level 3 per IPC-9503 and must be processed accordingly. To ensure product integrity and maintain the product warranty, these transformers require a 24 hour bake at +125° C prior to any solder reflow processing. Dried transformers must be reflowed within 24 hours. These parts are provided dry-packed in accordance with J-STD-033. Tape and Reel packaging is available upon request. Contact factory for further information. Reflow process must not cause the peak body temperature of the device to exceed 225° C and must not expose the device to temperatures above 183° C for more than 90 seconds.
 - 2) By providing surface mount parts that have been dried per IPC-9503 (Moisture Sensitivity Classification for Non-IC components) and Dry-Packed in accordance with J-STD-033 (Standard for handling, packing, shipping and use of Moisture/Reflow sensitive surface mount devices), Beta has significantly reduced the possibility of moisture sensitivity/reflow induced "Pop-corning" or Bulging during customer's reflow soldering process. Experiments performed by Beta and data provided by manufacturers of similar devices indicate that post reflow visual/mechanical anomalies can be reduced by more than 90%. Since customer reflow profiles and CCA density can vary, Beta recommends that the customer verify solder process compatibility and yield assessment of these devices.
 - 3) The Lead-Free/RoHS compliant versions use Sn10Pb88Ag02 for internal solder joints. High melting temperature solder in excess of 85% lead is exempt until a suitable alternative is available. The external lead finish is matte-tin with a nickel barrier layer that has been certified to pass JESD22A121.01 tin whisker limits. The magnet wire used has a minimum Thermo-plastic Flow rating of 250°C. These transformers are classified as IPC-9503 level 3. The peak body temperature shall not exceed 245°C, and the time over 183°C shall not exceed 150 seconds. The Lead-Free/RoHS compliant part numbers are the standard part, with an "-R" as the part number suffix. The bottom of the header has the Pb-free symbol embossed on it.

TAPE AND REEL MECHANICAL OUTLINE

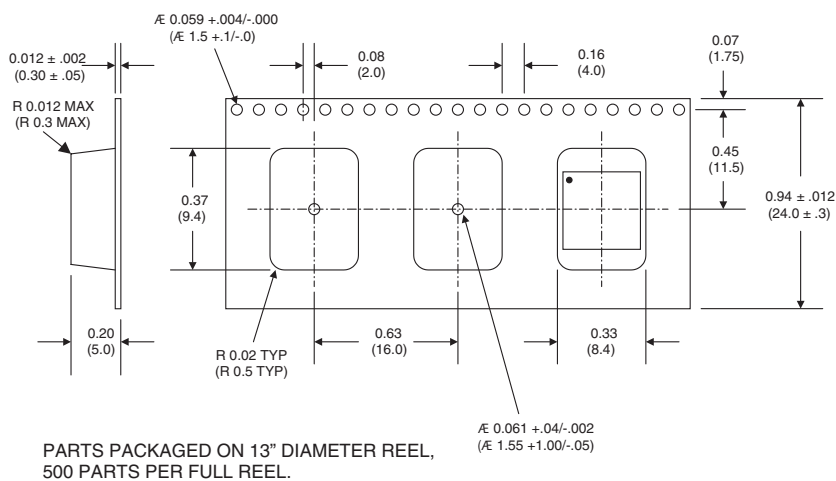

DIMENSIONS ARE IN
INCHES (MM)

TOLERANCES
XX = ± 0.10 (0.25)
XXX = ± 0.005 (0.13)

The information in this data sheet is believed to be accurate; however, no responsibility is assumed by Beta Transformer Technology Corporation for its use, and no license or rights are granted by implication or otherwise in connection therewith. Specifications are subject to change without notice.

Visit our Web site at www.bttc-beta.com for the latest information.



**BETA TRANSFORMER
TECHNOLOGY CORPORATION**

A Subsidiary of Data Device Corporation

40 Orville Drive, Bohemia, NY 11716-2529

Headquarters, N.Y., U.S.A. - Tel: (631) 244-7393

United Kingdom - Tel: +44-(0)1635-811140

Germany - Tel: +49-(0)89-1500-12-11

India - Tel: +91-80-46797-0368

World Wide Web - <http://www.bttc-beta.com>