

### General Description

The Qorvo TGA2526 is a compact LNA Gain Block MMIC with adjustable gain control (AGC). The LNA operates from 2-20 GHz and is designed using Qorvo proven standard 0.15  $\mu\text{m}$  Power pHEMT production process.

The TGA2526 provides a nominal 20 dBm of output power at 1 dB gain compression with a small signal gain of 17.5 dB. Greater than 30 dB adjustable gain can be achieved using the Vg2 pin. Typical noise figure is 2.5 dB at 12 GHz. Special circuitry on Vd, Vg1 and Vg2 pins provides ESD protection.

The TGA2526 is suitable for a variety of wideband systems such as point to point radios, radar warning receivers and electronic counter measures.

The TGA2526 is 100% DC and RF tested on-wafer to ensure performance compliance. The TGA2526 has a protective surface passivation layer providing environmental robustness.

### Applications

- Wideband Gain Block/LNA
- X-Ku Point to Point Radio
- Electronic Warfare Applications

### Product Features

- Frequency Range: 2-20 GHz
- Midband NF: 2.5 dB
- Gain: 17.5 dB
- >30 dB adjustable gain with Vg2
- TOI: 29 dBm Typical
- 22 dBm Nominal Psat, 20 dBm Nominal P1dB
- ESD Protection circuitry on Vd, Vg1, and Vg2
- Bias: Vd = 5 V, Id = 100 mA, Vg1 = -0.55 V, Vg2 = +1.3 V, Typical
- Technology: 3 MI 0.15  $\mu\text{m}$  Power pHEMT
- Chip Dimensions: 2.090 x 1.350 x 0.100 mm



### Measured Performance

Bias conditions: Vd = 5 V, Id = 100 mA, Vg1 = -0.55 V, Vg2 = +1.3 V Typical

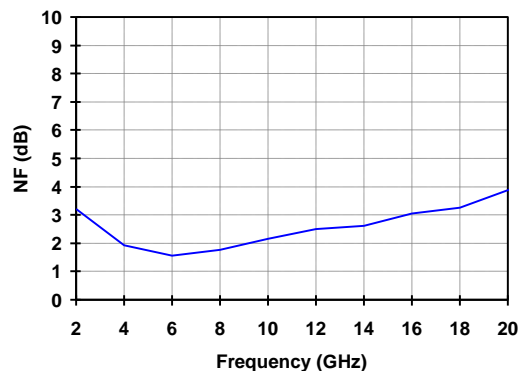
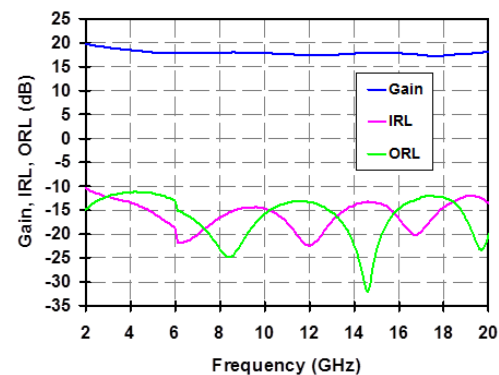

### Ordering Information

Part	Description
TGA2526	GaAs MMIC Die, Gel Pack, Qty 100
TGA2526EVB1	TGA2526 Evaluation Board, Qty 1
TGA2526-XCC-SPACE	Space Inspected Version; Contact Sales

### Absolute Maximum Ratings<sup>1/</sup>

Symbol	Parameter	Value	Notes
$V_D-V_G$	Drain to Gate Voltage	9 V	
$V_D$	Drain Voltage	7 V	<u>2/</u>
$V_{G1}$	Gate # 1 Voltage Range	-2 to 0 V	
$V_{G2}$	Gate # 2 Voltage Range	-2 to +3 V	
$I_D$	Drain Current	144 mA	<u>2/</u>
$I_{G1}$	Gate # 1 Current Range	-20 to 14 mA	
$I_{G2}$	Gate # 2 Current Range	-20 to 14 mA	
$P_{IN}$	Input Continuous Wave Power	22 dBm	<u>2/</u>
$T_{channel}$	Channel Temperature	200 °C	
$T_{storage}$	Storage Temperature	-55 to 150 °C	

- Note:
- 1/ These ratings represent the maximum operable values for this device. Stresses beyond those listed under “Absolute Maximum Ratings” may cause permanent damage to the device and / or affect device lifetime. These are stress ratings only, and functional operation of the device at these conditions is not implied.
  - 2/ Combinations of supply voltage, supply current, input power, and output power shall not exceed the maximum power dissipation listed in Table IV.
  - 3/ ESD protection diodes on  $V_D$ ,  $V_{G1}$  and  $V_{G2}$  will conduct current for voltages approaching turn-on voltages. Diode turn-on voltage levels will decrease with decreasing temperature.

## Recommended Operating Conditions

Symbol	Parameter <sup>1/</sup>	Value
V <sub>D</sub>	Drain Voltage	5 V
I <sub>D</sub>	Drain Current	100 mA
I <sub>D_Drive</sub>	Drain Current under RF Drive	144 mA
V <sub>G1</sub>	Gate # 1 Voltage	-0.55 V
V <sub>G2</sub>	Gate # 2 Voltage	1.3 V

Note:

<sup>1/</sup> See assembly diagram for bias instructions.

## RF Characterization Table

Bias: V<sub>D</sub> = 5 V, I<sub>D</sub> = 100 mA, V<sub>G1</sub> = -0.55 V, V<sub>G2</sub> = +1.3 V, typical. Ambient temperature: 25 °C  
 Data de-embedded to the end of RF feeds, data include bond wire effects

Symbol	Parameter	Test Conditions	Min	Normal	Max	Units
Gain	Small Signal Gain	f = 2–18 GHz f = 18–20 GHz	16 15	17.5 16		dB
IRL	Input Return Loss	f = 2–4 GHz f = 4–20 GHz	10 12	11 13		dB
ORL	Output Return Loss	f = 2–6 GHz f = 6–20 GHz	10 10	11 13		dB
Psat	Saturated Output Power	f = 2–18 GHz f = 18–20 GHz		22 20		dBm
P1dB	Output Power @ 1dB Compression	f = 2–16 GHz f = 16–20 GHz	17 15	20 17		dBm
TOI	Output TOI	f = 2–12 GHz f = 12–20 GHz		30 26		dBm
NF	Noise Figure	f = 2–4 GHz f = 4–14 GHz f = 14–20 GHz		3 2.5 3.5	3.5 3 4.5	dB

Measured Data

Bias conditions:  $V_D = 5\text{ V}$ ,  $I_D = 100\text{ mA}$ ,  $V_{G1} = -0.55\text{ V}$ ,  $V_{G2} = +1.3\text{ V}$  Typical,  $25\text{ }^\circ\text{C}$

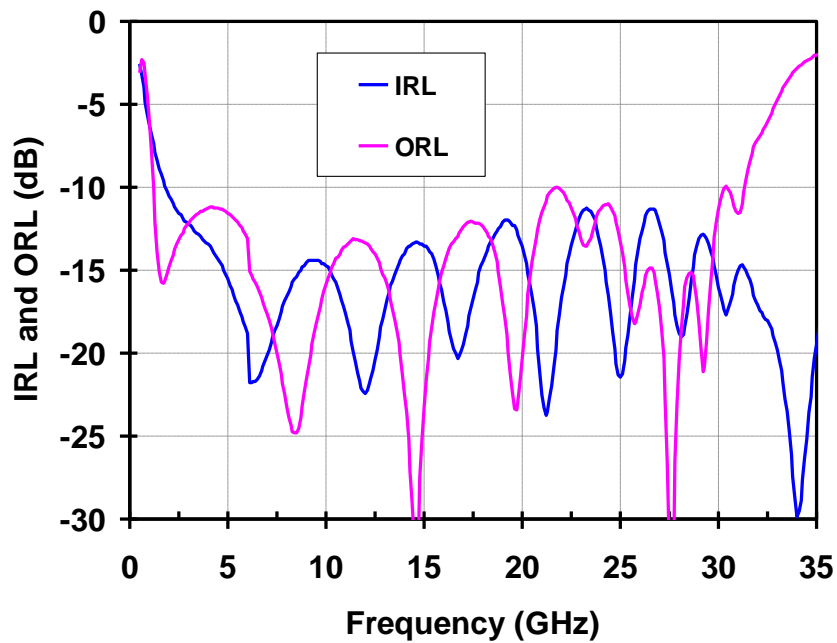
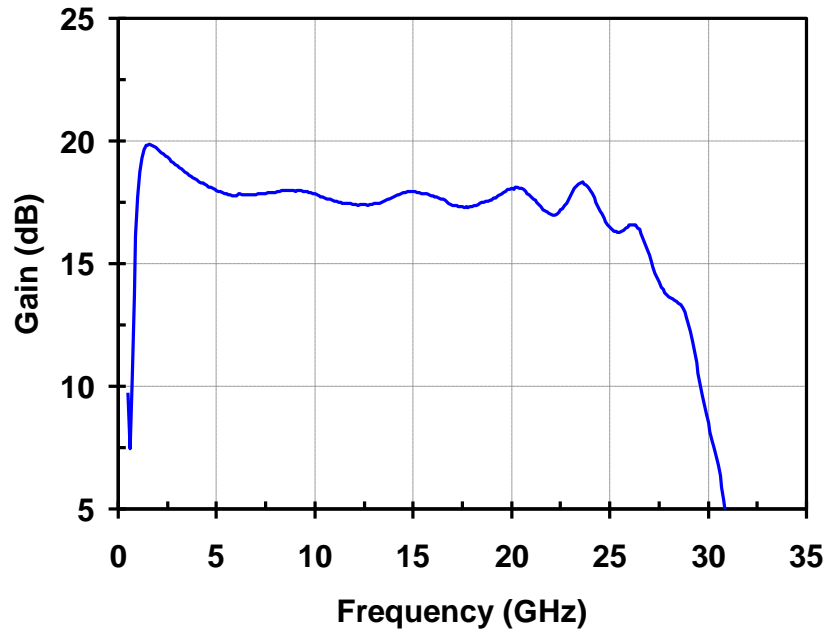

Measured Data

Bias conditions:  $V_D = 5\text{ V}$ ,  $I_D = 100\text{ mA}$ ,  $V_{G1} = -0.55\text{ V}$ ,  $V_{G2} = +1.3\text{ V}$  Typical,  $25\text{ }^\circ\text{C}$

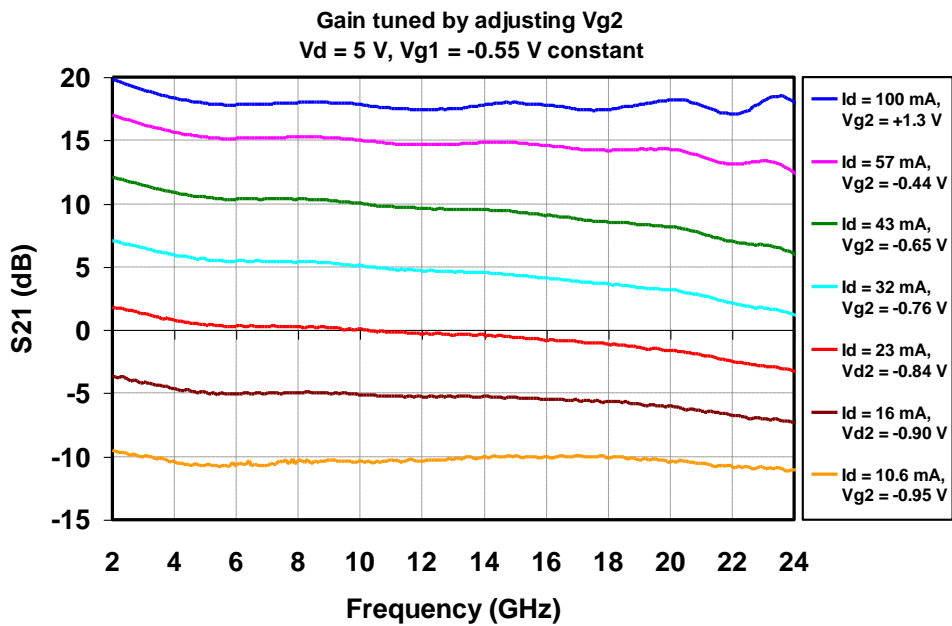
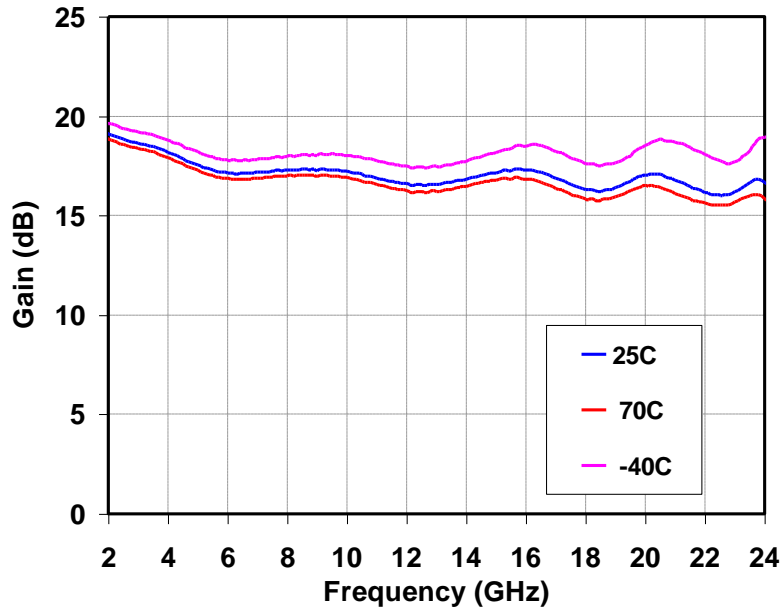

Measured Data

Bias conditions:  $V_D = 5\text{ V}$ ,  $I_D = 100\text{ mA}$ ,  $V_{G1} = -0.55\text{ V}$ ,  $V_{G2} = +1.3\text{ V}$  Typical,  $25\text{ }^\circ\text{C}$

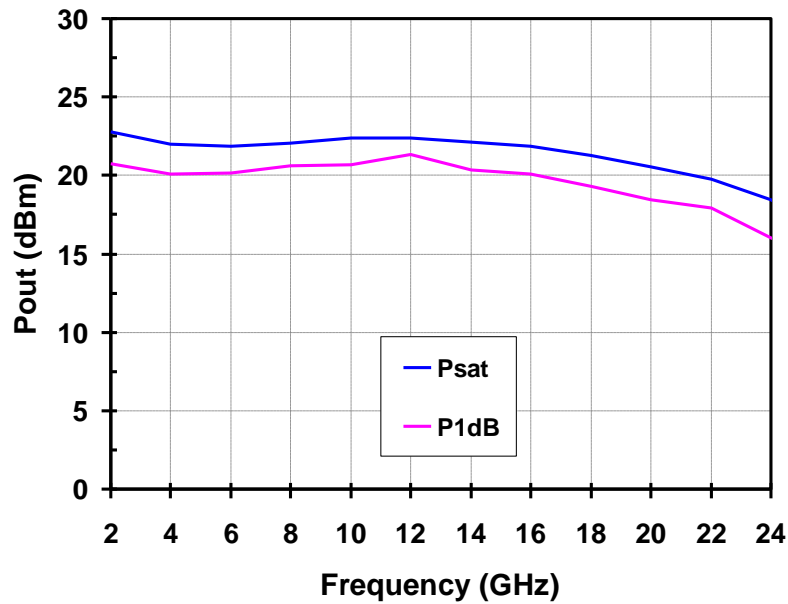
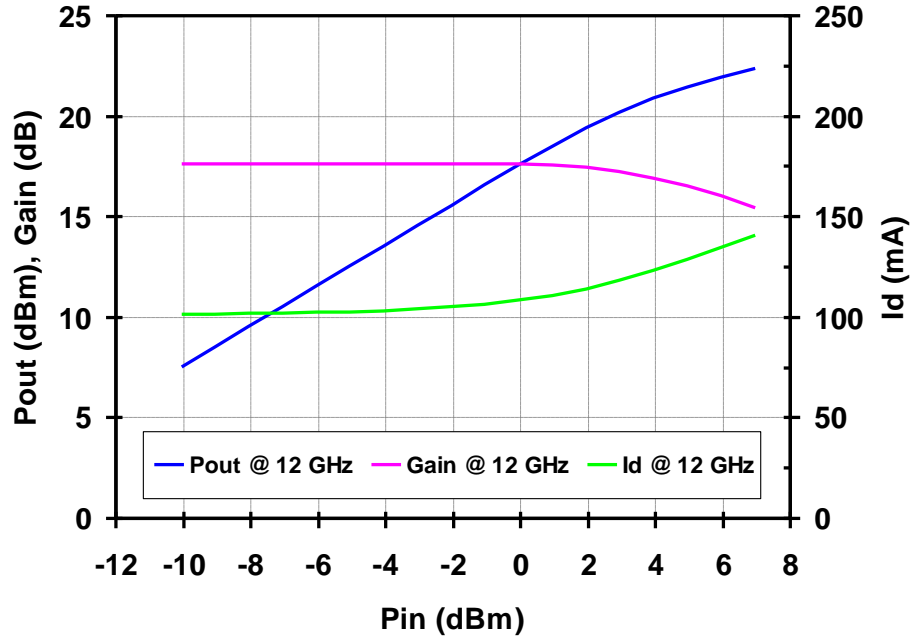

Measured Data

Bias conditions:  $V_D = 5\text{ V}$ ,  $I_D = 100\text{ mA}$ ,  $V_{G1} = -0.55\text{ V}$ ,  $V_{G2} = +1.3\text{ V}$  Typical,  $25\text{ }^\circ\text{C}$

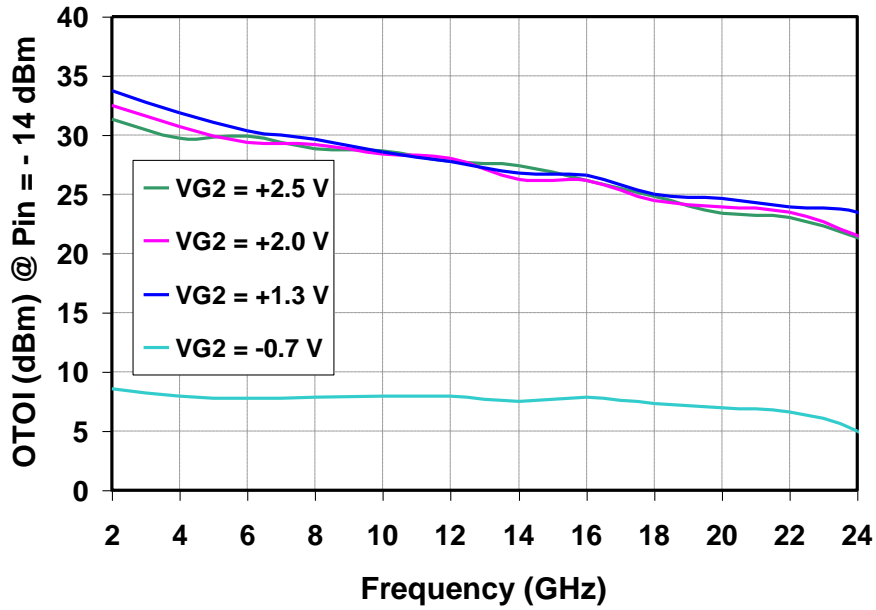
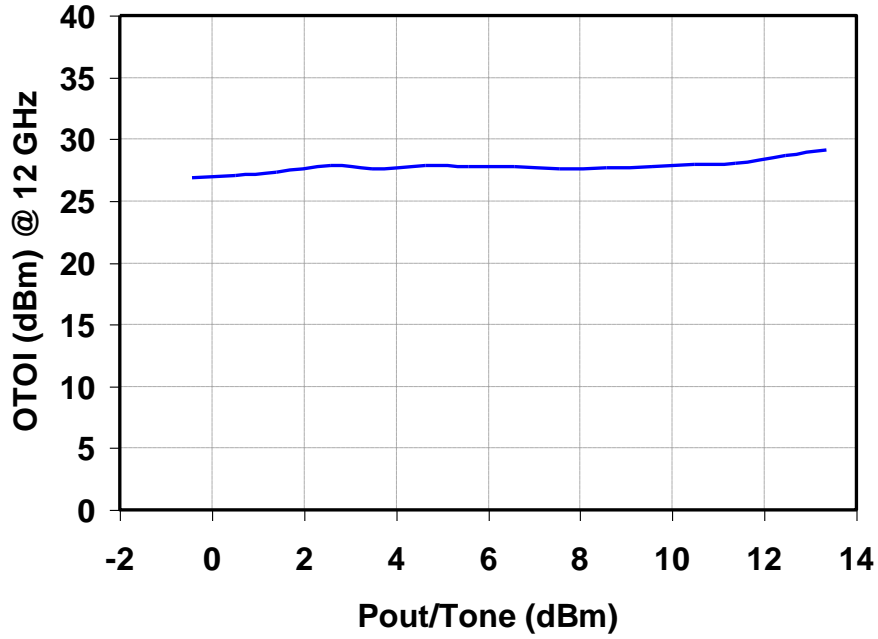

Measured Data

Bias conditions:  $V_D = 5\text{ V}$ ,  $I_D = 100\text{ mA}$ ,  $V_{G1} = -0.55\text{ V}$ ,  $V_{G2} = +1.3\text{ V}$  Typical,  $25\text{ }^\circ\text{C}$

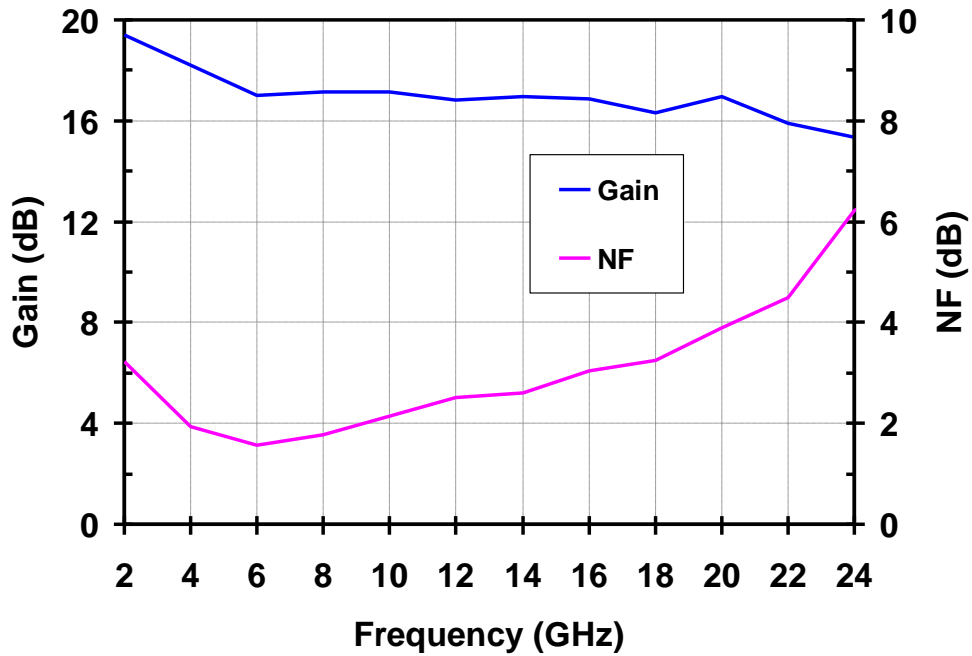

### Power Dissipation and Thermal Properties

Parameter	Test Conditions	Value
Maximum Power Dissipation	Tbaseplate = 70 °C	$P_D = 1.01\text{ W}$ $T_{channel} = 113\text{ °C}$ $T_m = 9.1\text{ E}+7\text{ Hrs}$
Thermal Resistance, $\theta_{jc}$	$V_D = 5\text{ V}$ $I_D = 100\text{ mA}$ $P_D = 0.5\text{ W}$	$\theta_{jc} = 42.2\text{ °C/W}$ $T_{channel} = 91\text{ °C}$ $T_m = 2.0\text{ E}+9\text{ Hrs}$
Thermal Resistance, $\theta_{jc}$ Under RF Drive	$V_D = 5\text{ V}$ $I_D = 144\text{ mA}$ $P_{OUT} = 22\text{ dBm}$ $P_D = 0.562\text{ W}$	$\theta_{jc} = 42.2\text{ °C/W}$ $T_{channel} = 94\text{ °C}$ $T_m = 1.3\text{ E}+9\text{ Hrs}$

### Median Lifetime vs Channel Temperature

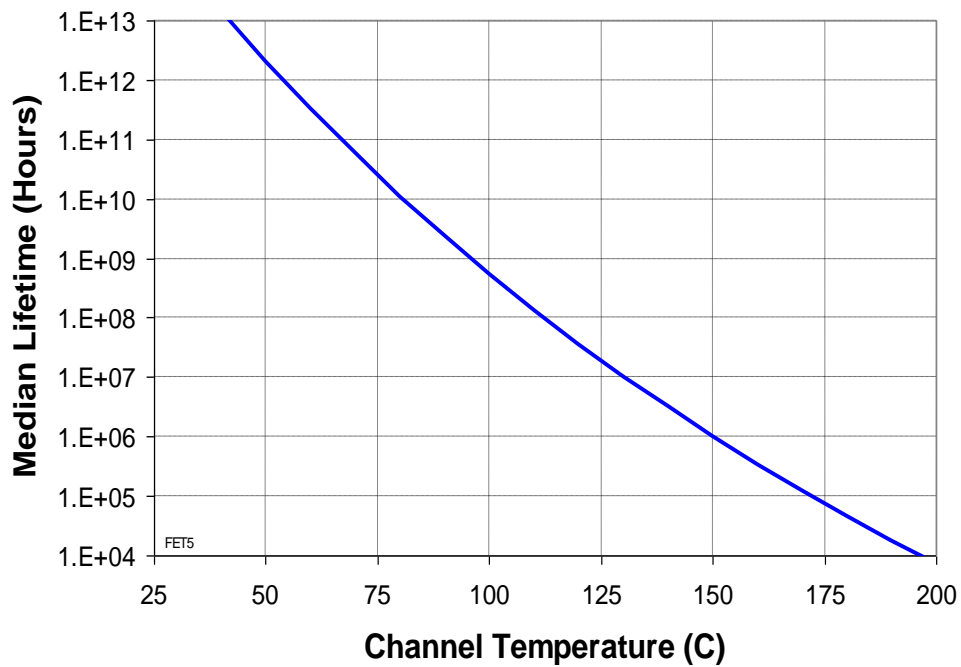

Electrical Schematic

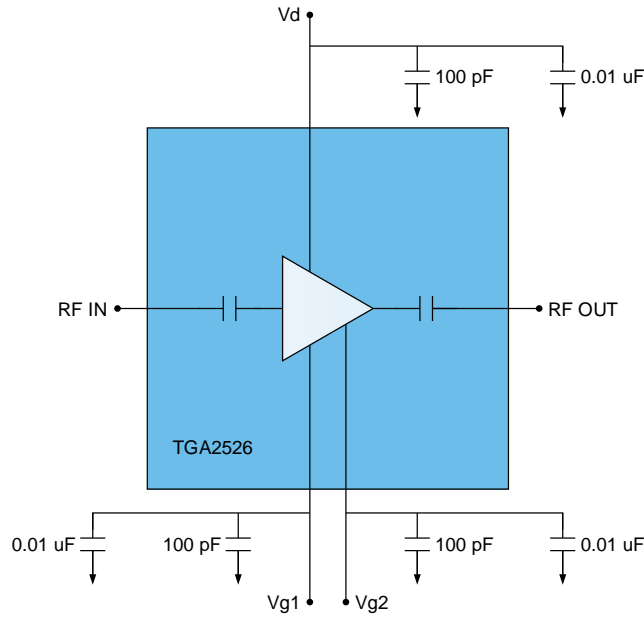

Bias Procedures

**Bias-up Procedure**

V<sub>G1</sub> set to -1.5 V

V<sub>D</sub> set to +5 V

V<sub>G2</sub> set to +1.3 V

Adjust V<sub>G1</sub> more positive until I<sub>d</sub> is 100 mA.  
This will be ~ V<sub>G1</sub> = -0.55 V

Apply RF signal to input

Adjust V<sub>G2</sub> to obtain desired gain.

**Bias-down Procedure**

Set V<sub>G2</sub> to +1.3 V

Turn off RF supply

Reduce V<sub>G1</sub> to -1.5 V. Ensure I<sub>d</sub> ~ 0 mA

Turn V<sub>G2</sub> to 0 V

Turn V<sub>D</sub> to 0 V

Turn V<sub>G1</sub> to 0 V

Mechanical Drawing and Bond Pad Description

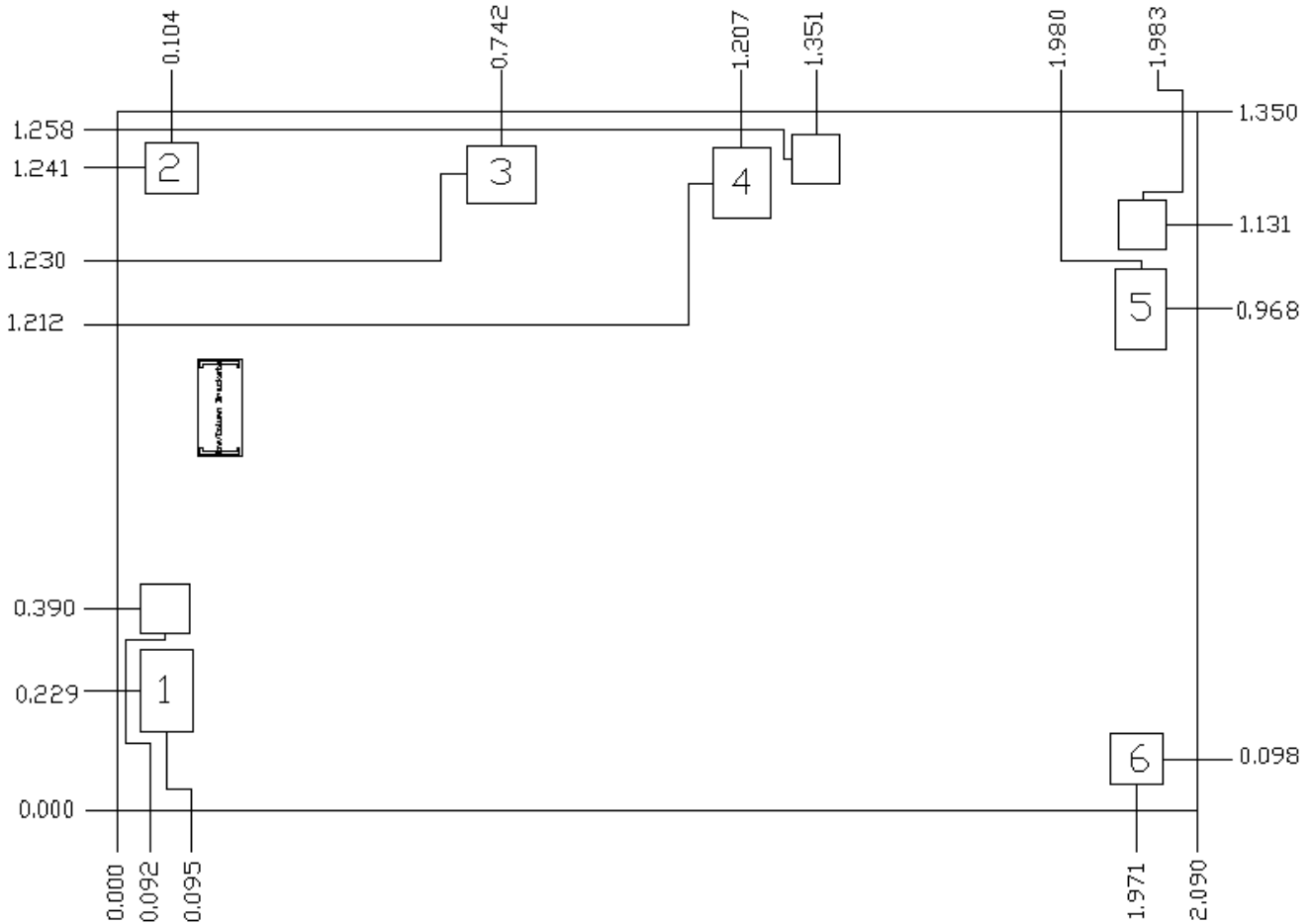

Unit: millimeters. Die thickness: 0.10, Die x, y size tolerance: +/- 0.050  
 Chip edge to bond pad dimensions are shown to center of pad. Ground is backside of die

Pad No.	Label	Pad Size (mm)	Description
1	RF Input	0.100 x 0.158	RF Input Port, matched to 50 ohms, DC blocked
2	VG2	0.100 x 0.100	Gate Voltage Control
3	VD1	0.135 x 0.110	Drain voltage termination, no connection required
4	VD	0.110 x 0.135	Drain Voltage
5	RF output	0.100 x 0.158	RF Output Port, matched to 50 ohms, DC blocked
6	VG1	0.100 x 0.100	Gate Voltage Control

Recommended Assembly Diagram

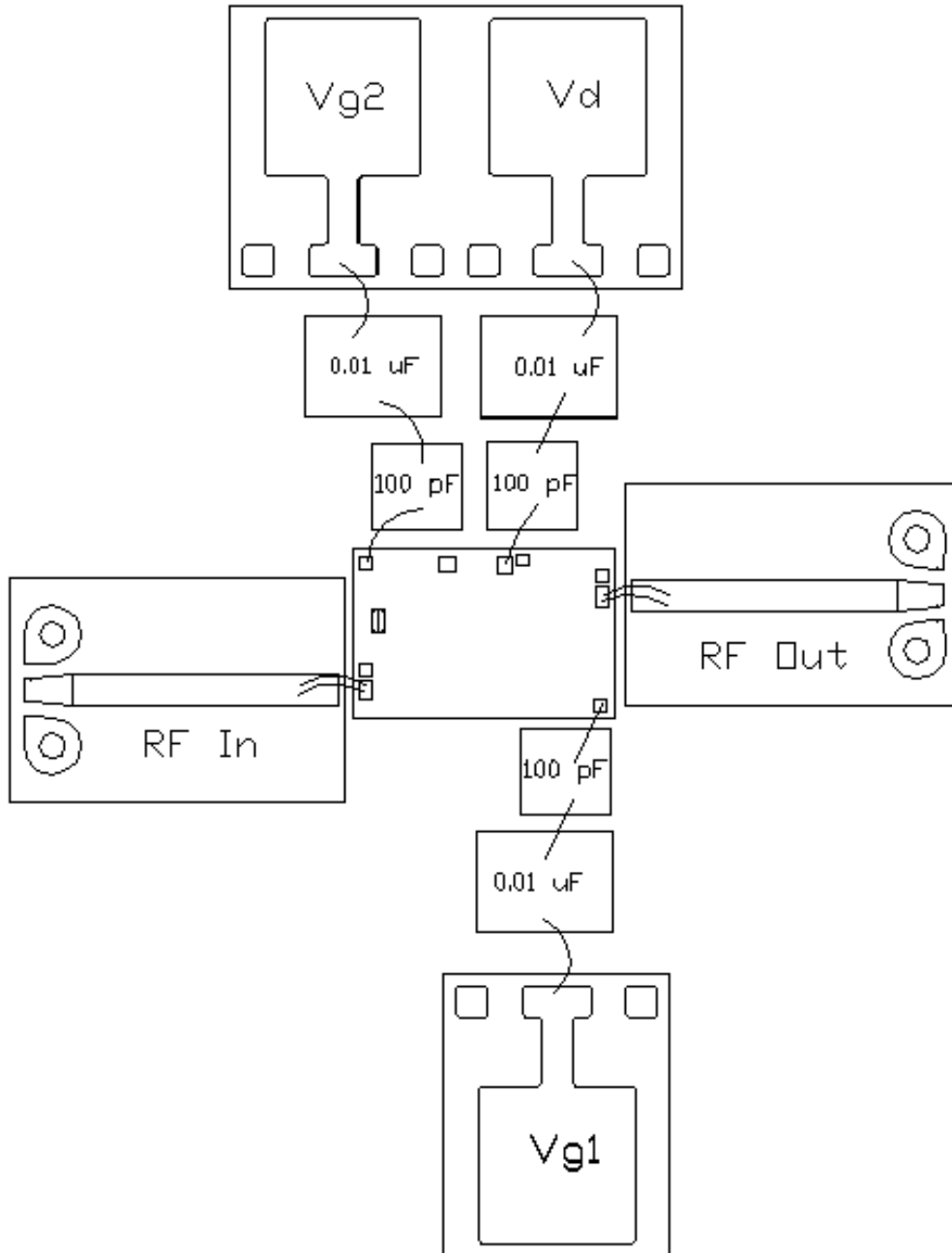

### Assembly Notes

---

Component placement and adhesive attachment assembly notes:

- Vacuum pencils and/or vacuum collets are the preferred method of pick up.
- Air bridges must be avoided during placement.
- The force impact is critical during auto placement.
- Organic attachment (i.e. epoxy) can be used in low-power applications.
- Curing should be done in a convection oven; proper exhaust is a safety concern.

Reflow process assembly notes:

- Use AuSn (80/20) solder and limit exposure to temperatures above 300 °C to 3-4 minutes, maximum.
- An alloy station or conveyor furnace with reducing atmosphere should be used.
- Do not use any kind of flux.
- Coefficient of thermal expansion matching is critical for long-term reliability.
- Devices must be stored in a dry nitrogen atmosphere.

Interconnect process assembly notes:

- Thermosonic ball bonding is the preferred interconnect technique.
- Force, time, and ultrasonic are critical parameters.
- Aluminum wire should not be used.
- Devices with small pad sizes should be bonded with 0.0007-inch wire.

### Handling Precautions

Parameter	Rating	Standard
ESD – Human Body Model (HBM)	TBD	ESDA / JEDEC JS-001-2017
ESD – Charged Device Model (CDM)	TBD	ESDA / JEDEC JS-002-2014
MSL – Convection Reflow 260 °C	N / A	



Caution!  
ESD-Sensitive Device

### RoHS Compliance

This part is compliant with 2011/65/EU RoHS directive (Restrictions on the Use of Certain Hazardous Substances in Electrical and Electronic Equipment) as amended by Directive 2015/863/EU.

This product also has the following attributes:

- Lead Free
- Halogen Free (Chlorine, Bromine)
- Antimony Free
- TBBP-A (C<sub>15</sub>H<sub>12</sub>Br<sub>4</sub>O<sub>2</sub>) Free
- SVHC Free
- PFOS Free

### Contact Information

For the latest specifications, additional product information, worldwide sales and distribution locations:

Tel: 1-844-890-8163

Web: [www.qorvo.com](http://www.qorvo.com)

Email: [customer.support@qorvo.com](mailto:customer.support@qorvo.com)

### Important Notice

The information contained herein is believed to be reliable; however, Qorvo makes no warranties regarding the information contained herein and assumes no responsibility or liability whatsoever for the use of the information contained herein. All information contained herein is subject to change without notice. Customers should obtain and verify the latest relevant information before placing orders for Qorvo products. The information contained herein or any use of such information does not grant, explicitly or implicitly, to any party any patent rights, licenses, or any other intellectual property rights, whether with regard to such information itself or anything described by such information. **THIS INFORMATION DOES NOT CONSTITUTE A WARRANTY WITH RESPECT TO THE PRODUCTS DESCRIBED HEREIN, AND QORVO HEREBY DISCLAIMS ANY AND ALL WARRANTIES WITH RESPECT TO SUCH PRODUCTS WHETHER EXPRESS OR IMPLIED BY LAW, COURSE OF DEALING, COURSE OF PERFORMANCE, USAGE OF TRADE OR OTHERWISE, INCLUDING THE IMPLIED WARRANTIES OF MERCHANTABILITY AND FITNESS FOR A PARTICULAR PURPOSE.**

Without limiting the generality of the foregoing, Qorvo products are not warranted or authorized for use as critical components in medical, life-saving, or life-sustaining applications, or other applications where a failure would reasonably be expected to cause severe personal injury or death.

© 2021 Qorvo US, Inc. All rights reserved. This document is subject to copyright laws in various jurisdictions worldwide and may not be reproduced or distributed, in whole or in part, without the express written consent of Qorvo US, Inc.

# Mouser Electronics

Authorized Distributor

Click to View Pricing, Inventory, Delivery & Lifecycle Information:

[Qorvo:](#)

[TGA2526](#)