

ZN459, ZN459CP

ULTRA LOW NOISE WIDEBAND PREAMPLIFIER

A versatile high grade a.c. pre-amplifier designed for applications requiring ultra low noise such as infra-red imaging and low noise wide band amplifiers e.g. microphone, acoustic emission, transducer bridge amplifier. The matching of open loop gain coupled with small physical size make the ZN459 series ideal for multichannel amplification.

FEATURES

- High Controlled Gain : 60dB \pm 1dB typical
- Low Noise : 40 Ω Equivalent Noise Resistance, or 800pV/ $\sqrt{\text{Hz}}$
- Wide bandwidth : 15MHz typical
- Low Supply Current : <3mA from 5V

ABSOLUTE MAXIMUM RATINGS

Supply voltage	6 Volts
Operating Temperature Range:	
for ZN459	-55 to +125°C
for ZN459CP	0 to +70°C
Storage Temperature Range	-55 to +125°C

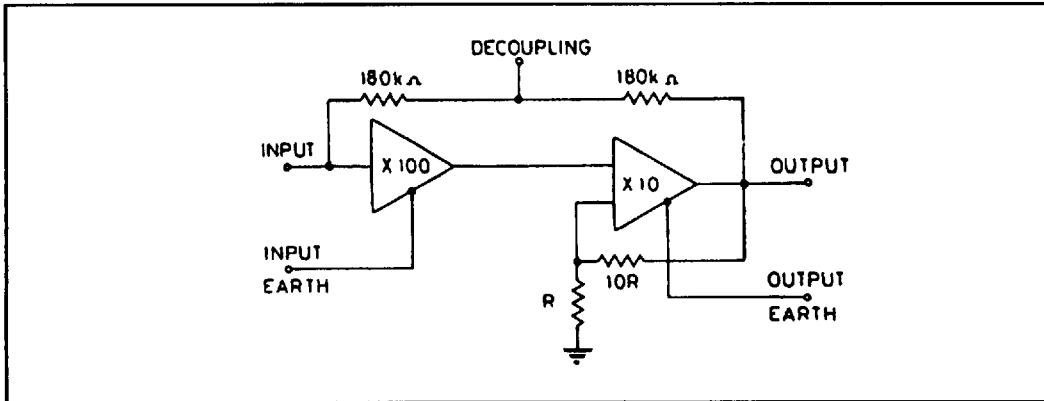
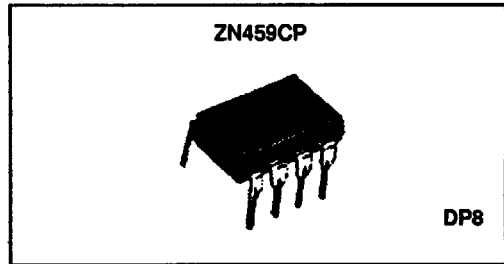
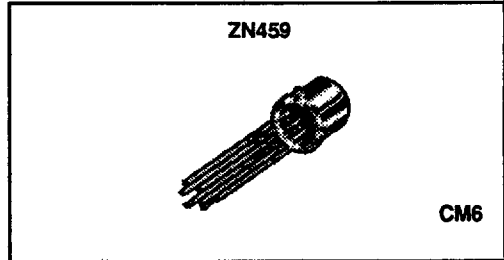

Fig.1 ZN459 Outline circuit

ELECTRICAL CHARACTERISTICS

Test conditions (unless otherwise stated):

($V_{cc} = 5V, T_{amb} = 25^{\circ}C$)

Parameter	Min.	Typ.	Max.	Units	Conditions
Supply Current	2.0	2.5	3.0	mA	
Voltage Gain	59	60	61	dB	10KHz
TC of Voltage Gain		-0.2		%/°C	
V_{cc} Coefficient of Voltage Gain		25		%/V	
Cut-off Frequency		15		MHz	3dB down
Input Resistance	3.5	7		k Ω	10KHz
Input Capacitance		80		pF	Note 1
Noise Resistance		40		Ω	$R_s = 0$
White Noise Voltage		800	1100	$\mu V/\sqrt{Hz}$	$R_s = 0$
L.F. Spot Noise		3		nV/\sqrt{Hz}	$R_s = 0, f = 25Hz$
White Noise Current		1		$\mu A/\sqrt{Hz}$	
Output Level	1.5	2.0	2.5	V	
Supply Voltage Coefficient of Output Level		0.34		V/V	
Output Current Limit	0.6	0.8	1.1	mA	Sink current
Total Harmonic Distortion		0.15		%	1 Vpp at 10KHz
Output Resistance		75		Ω	10KHz
Supply Rejection Ratio		42.5		dB	
Delay Time		20		ns	Small signal
Delay Time		40		ns	100mV rms input
Positive Input Overdrive		10		mA	
Negative Input Overdrive		-5		V	

Note 1: In P.C.B. The input capacitance may be reduced to 25pF by screening between output and input.

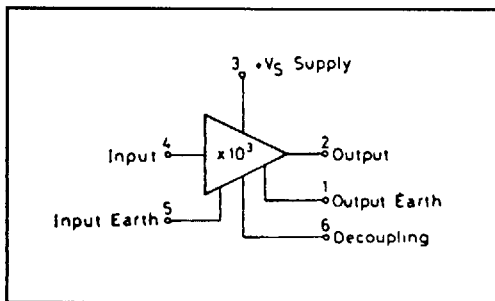

Fig.2 Pinning configuration - ZN459

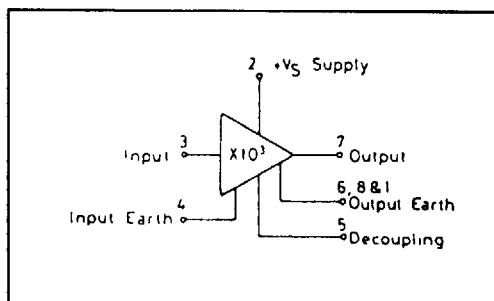

Fig.3 Pinning configuration - ZN459CP

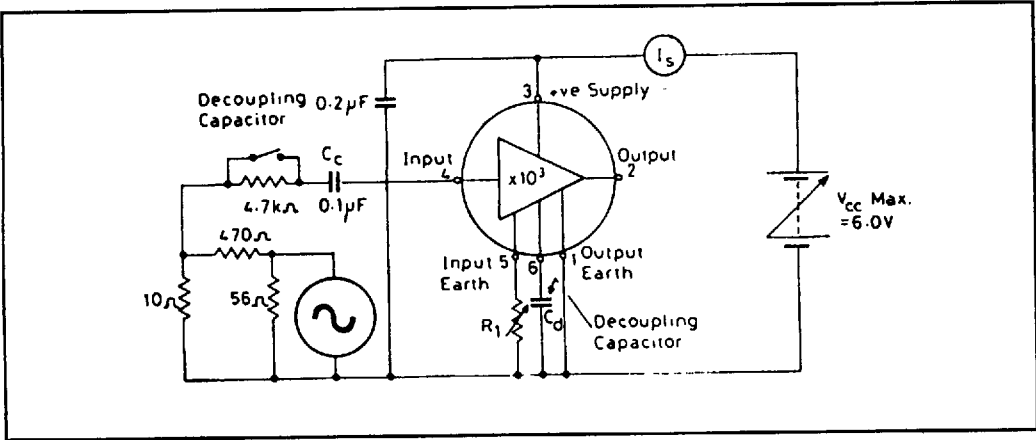

Fig.4 Gain Test Circuit (ZN459)

The input impedance may be increased at the expense of noise by including R_1 to vary the gain ($R_1 = 0$, gain = 10^3 ; $R_1 = 470\Omega$, gain = 10^2).

C_c is required to decouple the internal feedback loop and in order to obtain a flat frequency response make $C_c \geq C_c$.

The earth lead of the supply decoupling capacitor should be as close as possible to that of R_1 .

For optimum Common Mode Rejection connect a twisted pair between source and pins 4 and 5 of the device and complete the earth return from source ground.

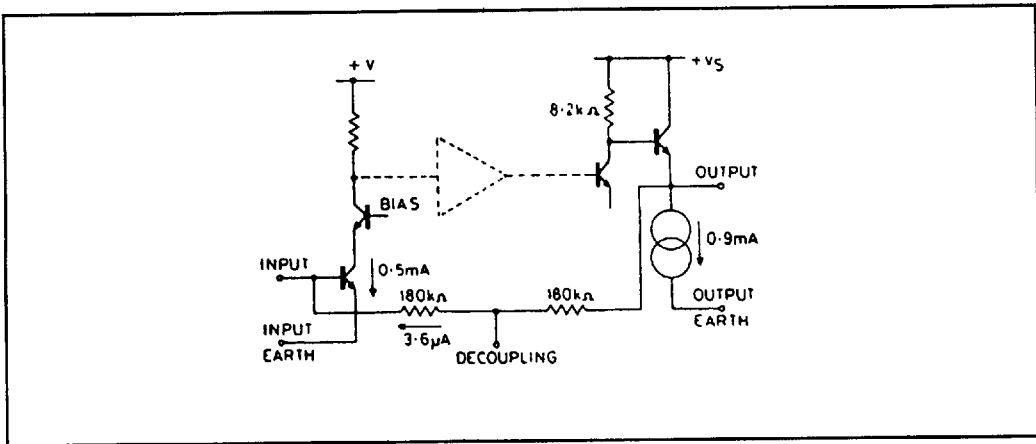

Fig.5 ZN459 Input and output circuit

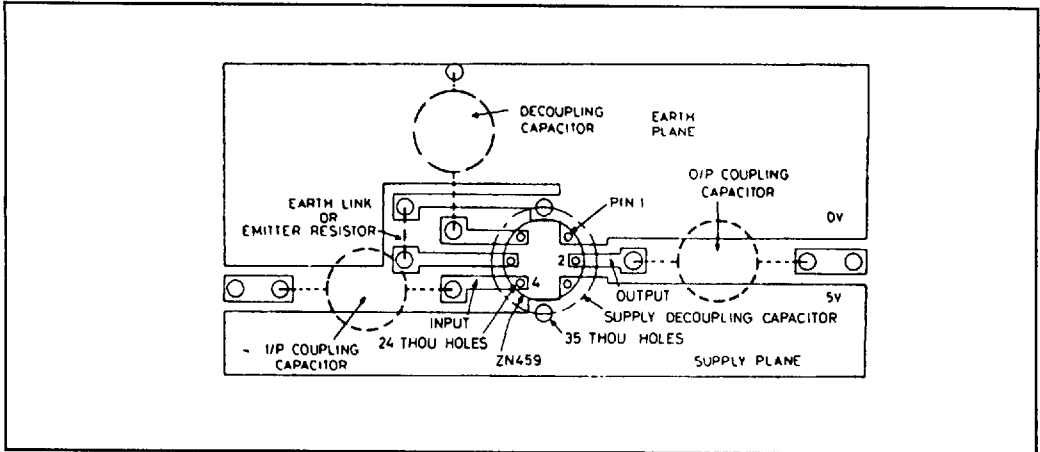

Fig. 6 PCB layout (ZN459)

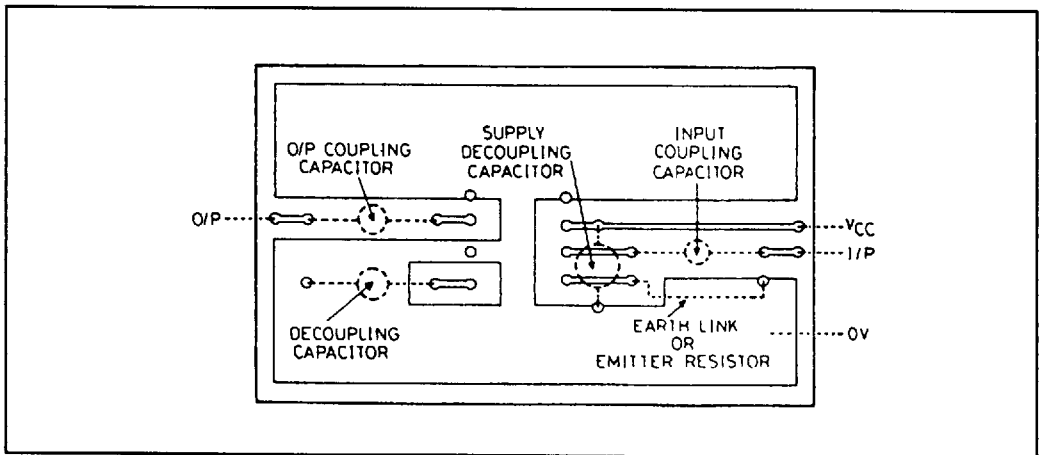

Fig. 7 PCB layout (ZN459CP)

TYPICAL CHARACTERISTICS

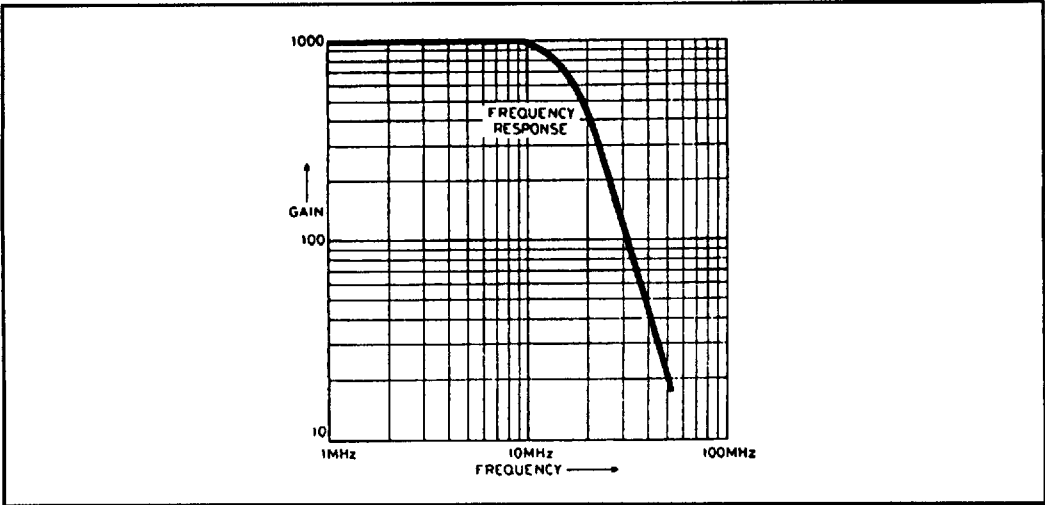

Fig.8 Gain V_s Frequency

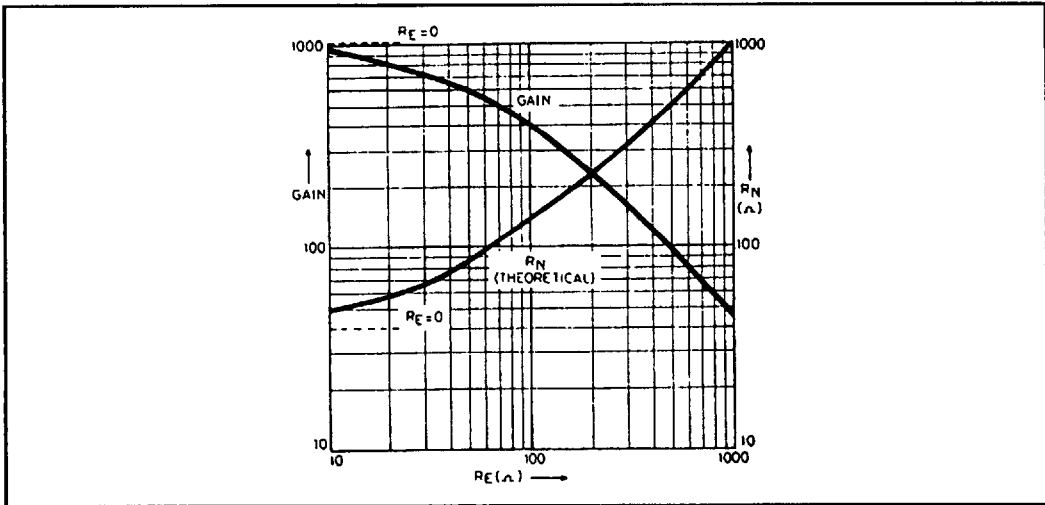

Fig.9 Gain and noise resistance V_s emitter resistance

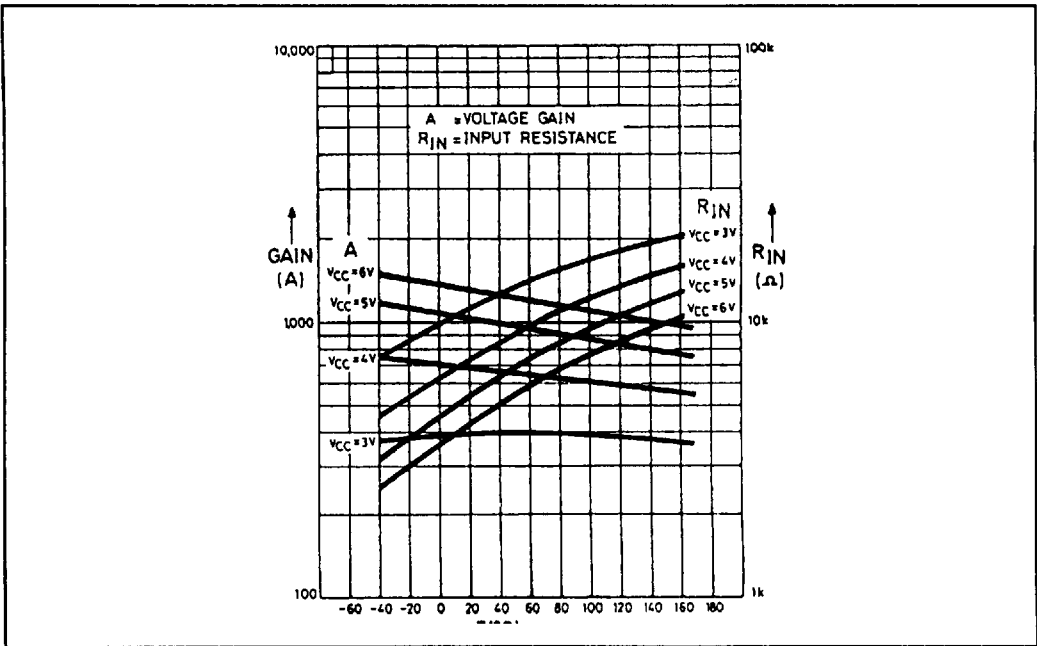

Fig.10 Gain and Input Impedance

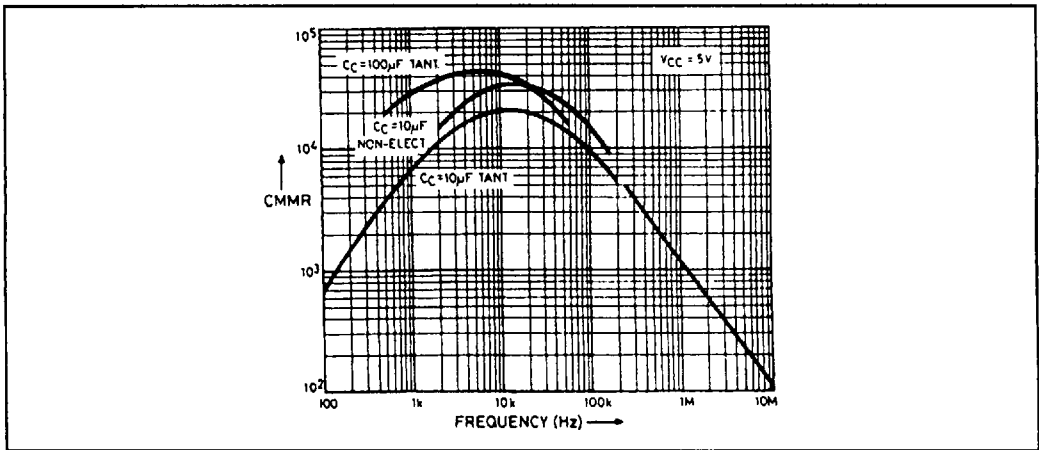

Fig.11 Common Mode Rejection Vs Frequency
 (Measured between input earth and output earth)

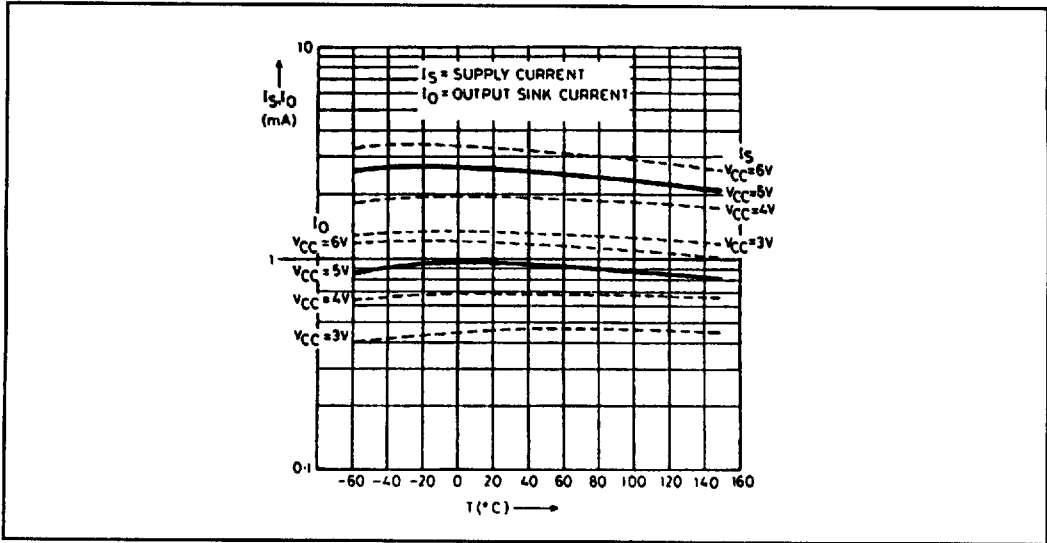

Fig.12 Supply Current and Output Sink Current

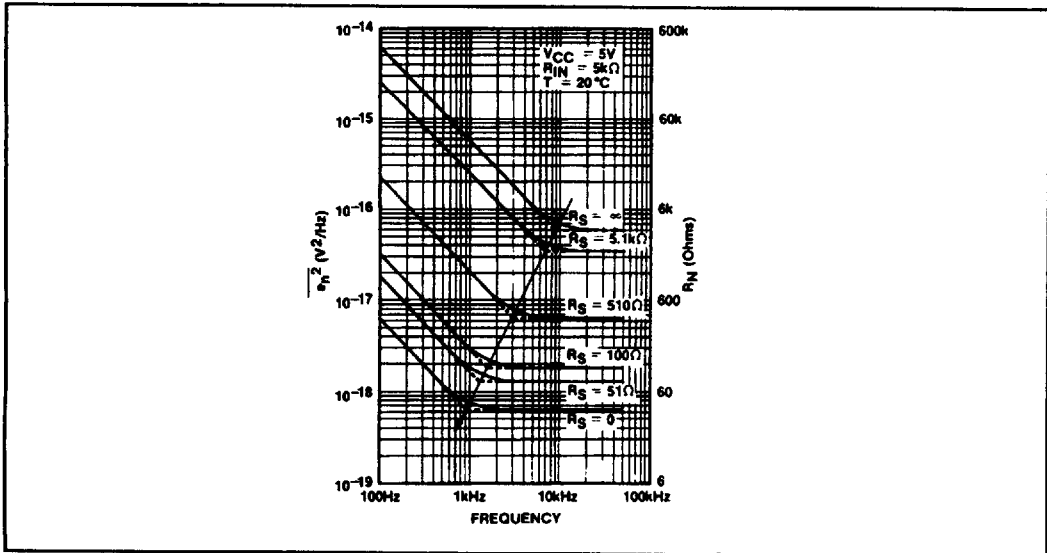

Fig.13 Noise Voltage

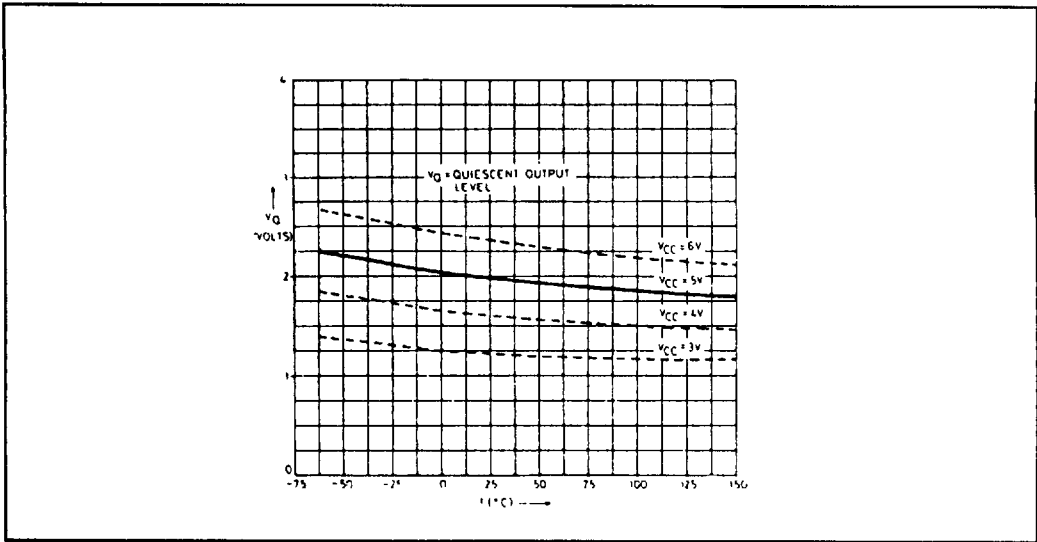

Fig. 14 Quiescent Output Level