

## 1 Form A Solid State Relay

### Features

- Current Limit Protection
- Isolation Test Voltage 5300 V<sub>RMS</sub>
- Typical R<sub>ON</sub> 28 Ω
- Load Voltage 350 V
- Load Current 120 mA
- High Surge Capability
- Clean Bounce Free Switching
- Low Power Consumption
- High Reliability Monolithic Receptor
- SMD lead available on tape and reel
- Equivalent to CP Clare LCA110
- Lead-free component
- Component in accordance to RoHS 2002/95/EC and WEEE 2002/96/EC

### Agency Approvals

- UL1577, File No. E52744 System Code H or J, Double Protection
- CSA - Certification 093751
- BSI/BABT Cert. No. 7980
- FIMKO Approval

### Applications

General Telecom Switching

- On/off Hook Control
- Ring Delay
- Dial Pulse
- Ground Start
- Ground Fault Protection

Instrumentation

Industrial Controls

See "Solid State Relays" (Application Note 56)

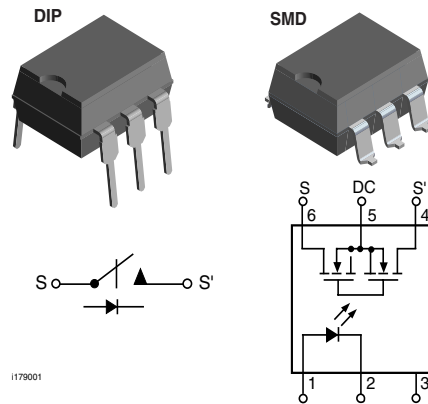

### Description

The LH1546 is robust, ideal for telecom and ground fault applications. It is a SPST normally open switch (1 Form A) that replaces electromechanical relays in many applications. It is constructed using a GaAlAs LED for actuation control and an integrated monolithic die for the switch output. The die, fabricated in a high-voltage dielectrically isolated technology, is comprised of a photodiode array, switch control circuitry and MOSFET switches. In addition, it employs current-limiting circuitry which meets FCC 68.302 and other regulatory voltage surge requirements when overvoltage protection is provided.

### Customer Specific Requirement

- Order information has been changed to identify that the product is lead free.

### Order Information

Part	Remarks
LH1546AAB-E3	Tubes, SMD-6
LH1546AABTR-E3	Tape and Reel, SMD-6
LH1546AT-E3	Tubes, DIP-6

### Absolute Maximum Ratings, $T_{amb} = 25\text{ }^{\circ}\text{C}$

Stresses in excess of the absolute Maximum Ratings can cause permanent damage to the device. Functional operation of the device is not implied at these or any other conditions in excess of those given in the operational sections of this document. Exposure to absolute Maximum Ratings for extended periods of time can adversely affect reliability.

### SSR

Parameter	Test condition	Symbol	Value	Unit
SSR output power dissipation (continuous)		$P_{diss}$	550	mW
LED continuous forward current		$I_F$	50	mA
LED reverse voltage	$I_R \leq 10\text{ }\mu\text{A}$	$V_R$	8.0	V
DC or peak AC load voltage	$I_L \leq 50\text{ }\mu\text{A}$	$V_L$	350	V
Continuous DC load current at 25 °C, Bidirectional			120	mA
Continuous DC load current at 25 °C, Unidirectional			200	mA
Ambient temperature range		$T_{amb}$	- 40 to + 85	°C
Storage temperature range		$T_{stg}$	- 40 to + 150	°C
Soldering temperature	t = 10 s max	$T_{sld}$	260	°C
Isolation test voltage	for 1.0 s	$V_{IO}$	5300	$V_{RMS}$
Isolation resistance	$V_{IO} = 500\text{ V}$ , $T_{amb} = 25\text{ }^{\circ}\text{C}$	$R_{IO}$	$\geq 10^{12}$	$\Omega$
	$V_{IO} = 500\text{ V}$ , $T_{amb} = 100\text{ }^{\circ}\text{C}$	$R_{IO}$	$\geq 10^{11}$	$\Omega$

### Electrical Characteristics, $T_{amb} = 25\text{ }^{\circ}\text{C}$

Minimum and maximum values are testing requirements. Typical values are characteristics of the device and are the result of engineering evaluations. Typical values are for information only and are not part of the testing requirements.

### Input

Parameter	Test condition	Symbol	Min	Typ.	Max	Unit
LED forward current, switch turn-on	$I_L = 100\text{ mA}$ , t = 10 ms	$I_{Fon}$		1.1	2.0	mA
LED forward current, switch turn-off	$V_L = \pm 350\text{ V}$	$I_{Foff}$	0.2	1.0		mA
LED forward voltage	$I_F = 10\text{ mA}$	$V_F$	1.15	1.26	1.45	V

### Output

Parameter	Test condition	Symbol	Min	Typ.	Max	Unit
ON-resistance, ac/dc: Pin 4 ( $\pm$ ) to 6 ( $\pm$ )	$I_F = 5.0\text{ mA}$ , $I_L = 50\text{ mA}$	$R_{ON}$		28	35	$\Omega$
ON-resistance, dc: Pin 4, 6 (+) to 5 (-)	$I_F = 5.0\text{ mA}$ , $I_L = 50\text{ mA}$	$R_{ON}$		7.0	10.0	$\Omega$
OFF-resistance	$I_F = 0\text{ mA}$ , $V_L = \pm 100\text{ V}$	$R_{OFF}$	0.5	300		$G\Omega$
Current limit ac/dc	$I_F = 5.0\text{ mA}$ , t = 5.0 ms, $V_L = 6.0\text{ V}$	$I_{LMT}$	170	210	250	mA
Off-state leakage current	$I_F = 0\text{ mA}$ , $V_L = \pm 100\text{ V}$	$I_O$		0.35	200	nA
	$I_F = 0\text{ mA}$ , $V_L = \pm 350\text{ V}$	$I_O$		0.096	1.0	nA
Output capacitance Pin 4 to 6	$I_F = 0\text{ mA}$ , $V_L = 1.0\text{ V}$	$C_O$		18		pF
	$I_F = 0\text{ mA}$ , $V_L = 50\text{ V}$	$C_O$		6.7		pF
Switch offset	$I_F = 5.0\text{ mA}$	$V_{OS}$		0.3		$\mu\text{A}$

## Transfer

Parameter	Test condition	Symbol	Min	Typ.	Max	Unit
Capacitance (input-output)	$V_{ISO} = 1.0\text{ V}$	$C_{IO}$		0.67		pF
Turn-on time	$I_F = 5.0\text{ mA}$ , $I_L = 50\text{ mA}$	$t_{on}$		1.14	3.0	ms
Turn-off time	$I_F = 5.0\text{ mA}$ , $I_L = 50\text{ mA}$	$t_{off}$		0.71	3.0	ms

## Typical Characteristics ( $T_{amb} = 25\text{ }^\circ\text{C}$ unless otherwise specified)

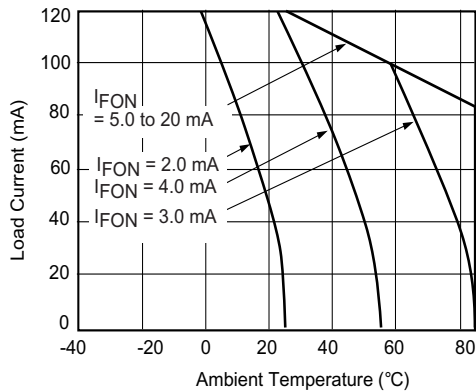

ih1546at\_00

Figure 1. Recommended Operating Conditions

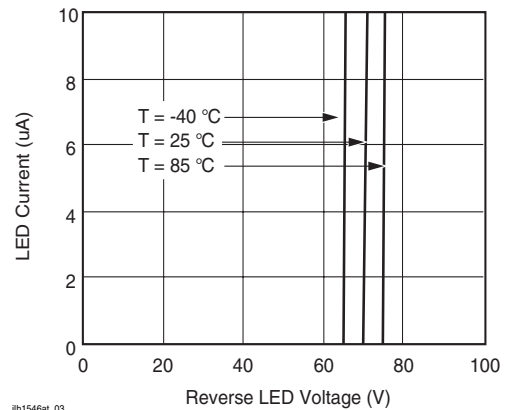

ih1546at\_03

Figure 3. LED Reverse Current vs. LED Reverse Voltage

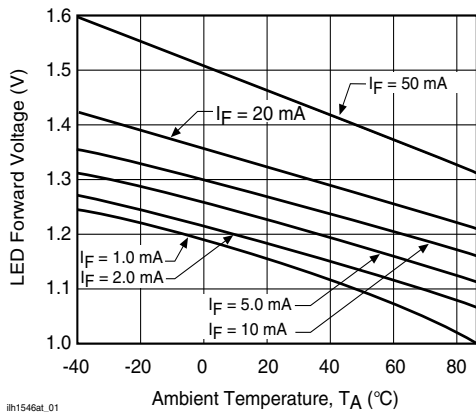

ih1546at\_01

Figure 2. LED Voltage vs. Temperature

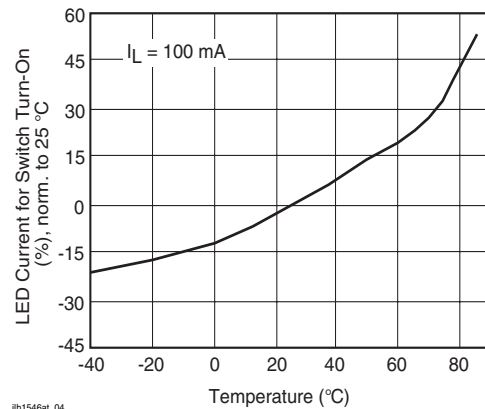

ih1546at\_04

Figure 4. LED Current for Switch Turn-on vs. Temperature

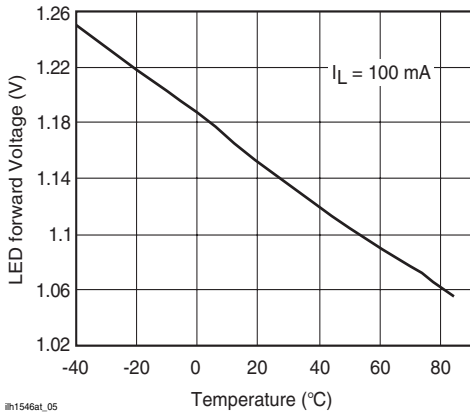

Figure 5. LED Dropout Voltage vs. Temperature

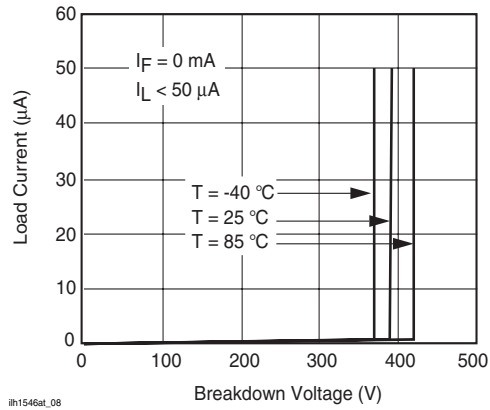

Figure 8. Switch Breakdown Voltage vs. Load Current

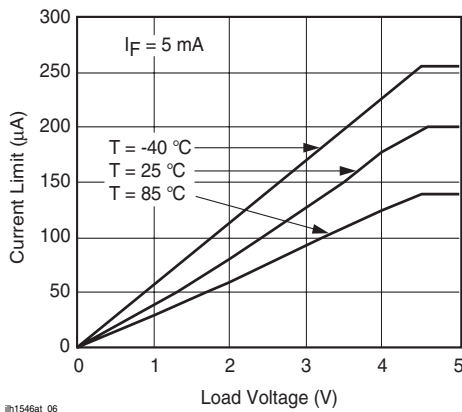

Figure 6. Load Current vs. Load Voltage

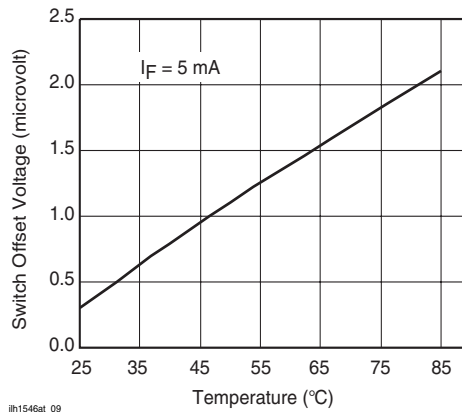

Figure 9. Switch Offset Voltage vs. LED Current

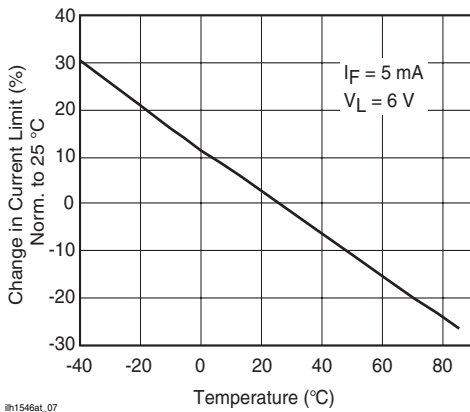

Figure 7. Current Limit vs. Temperature

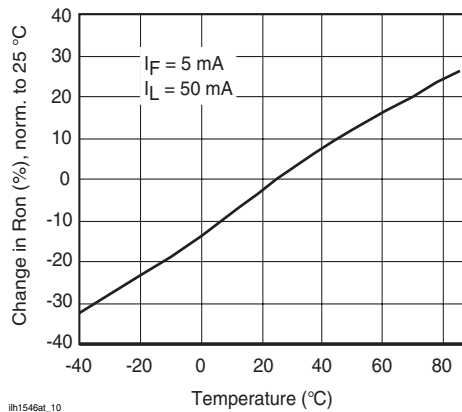

Figure 10. ON-Resistance vs. Temperature

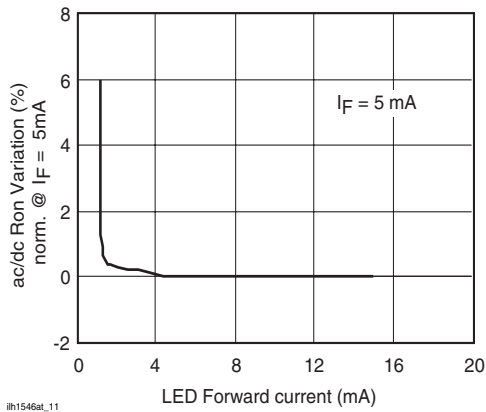

Figure 11. Variation in ON-Resistance vs. LED Current

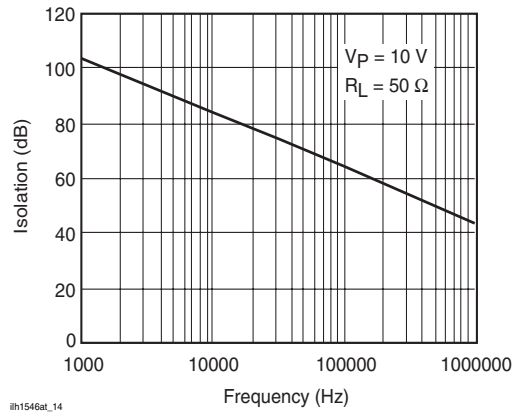

Figure 14. Output Isolation

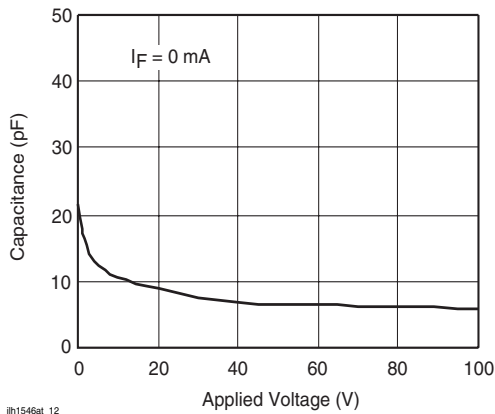

Figure 12. Switch Capacitance vs. Applied Voltage

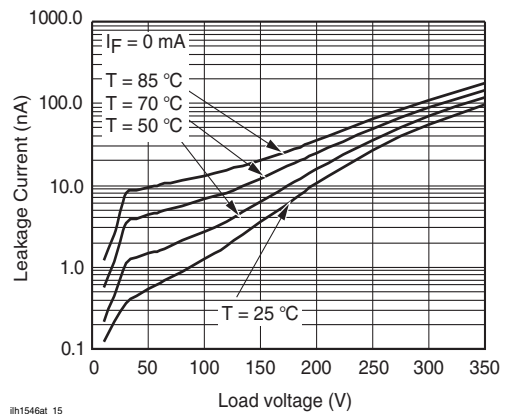

Figure 15. Leakage Current vs. Applied Voltage at Elevated Temperatures

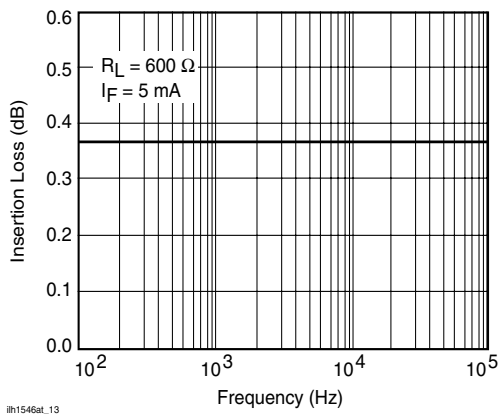

Figure 13. Insertion Loss vs. Frequency

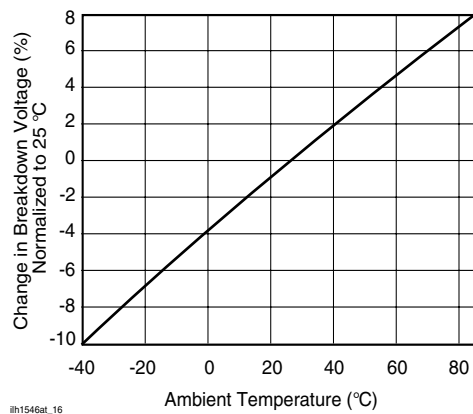

Figure 16. Switch Breakdown Voltage vs. Temperature

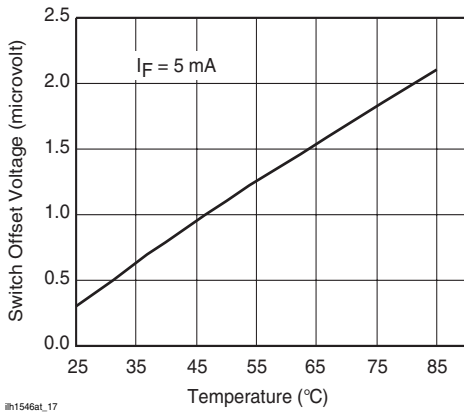

Figure 17. Switch Offset Voltage vs. Temperature

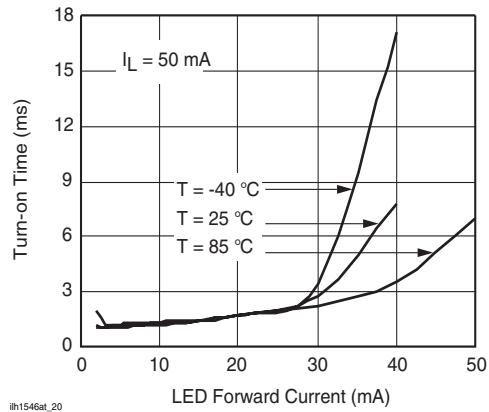

Figure 20. Turn-on Time vs. LED Current

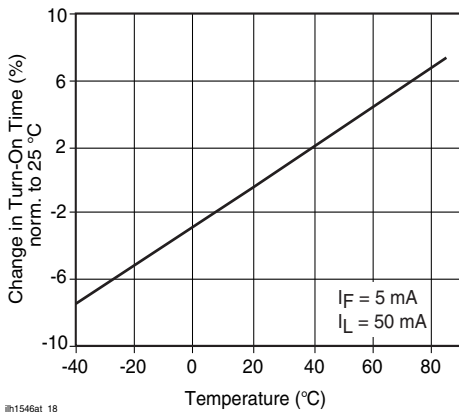

Figure 18. Turn-on Time vs. Temperature

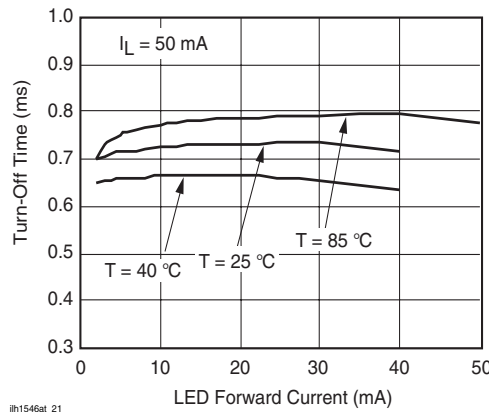

Figure 21. Turn-off Time vs. LED Current

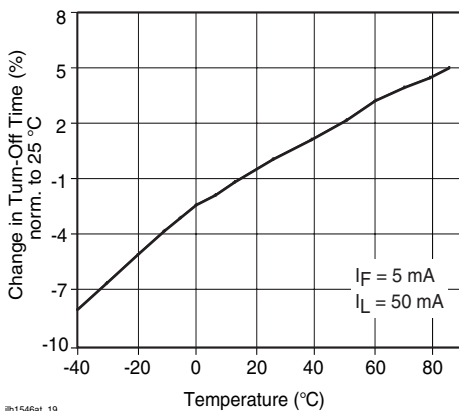
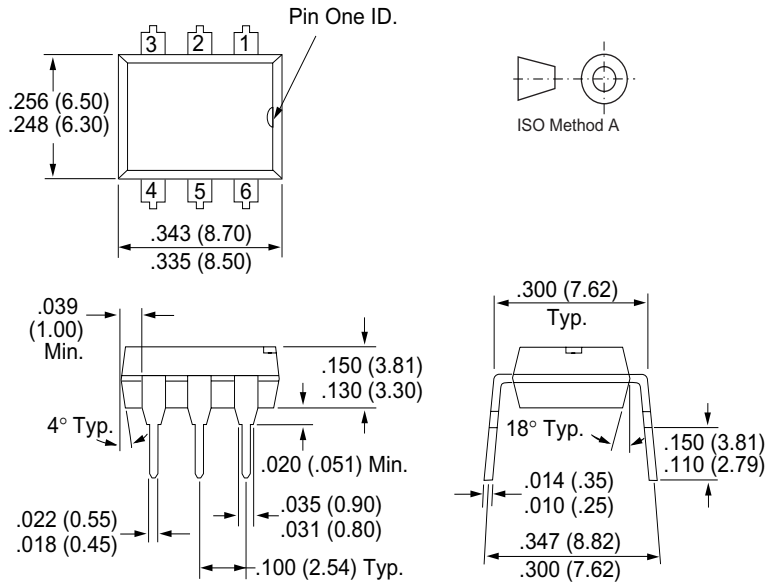

Figure 19. Turn-off Time vs. Temperature

## Package Dimensions in Inches (mm)

### DIP



## Package Dimensions in Inches (mm)

### SMD

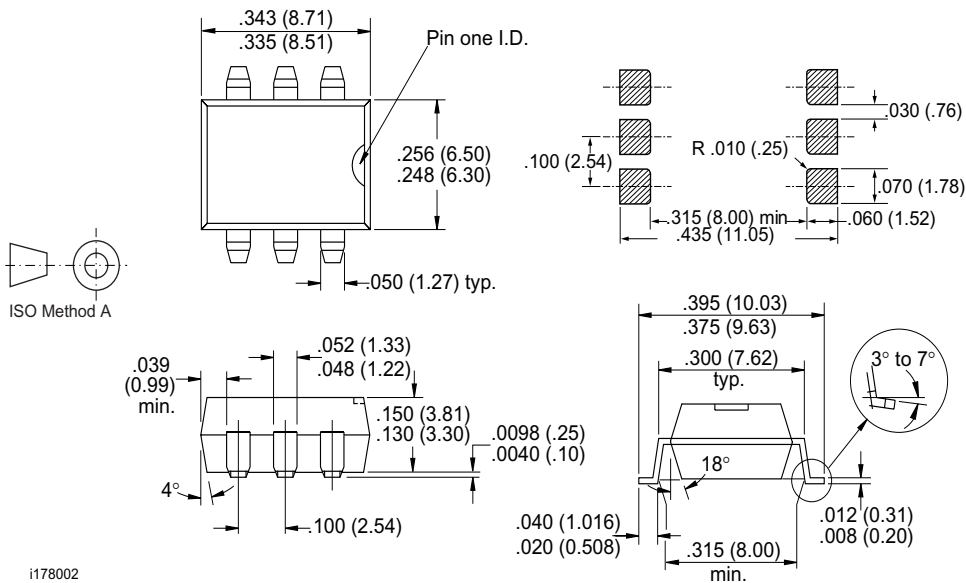

### Ozone Depleting Substances Policy Statement

It is the policy of Vishay Semiconductor GmbH to

1. Meet all present and future national and international statutory requirements.
2. Regularly and continuously improve the performance of our products, processes, distribution and operating systems with respect to their impact on the health and safety of our employees and the public, as well as their impact on the environment.

It is particular concern to control or eliminate releases of those substances into the atmosphere which are known as ozone depleting substances (ODSs).

The Montreal Protocol (1987) and its London Amendments (1990) intend to severely restrict the use of ODSs and forbid their use within the next ten years. Various national and international initiatives are pressing for an earlier ban on these substances.

Vishay Semiconductor GmbH has been able to use its policy of continuous improvements to eliminate the use of ODSs listed in the following documents.

1. Annex A, B and list of transitional substances of the Montreal Protocol and the London Amendments respectively
2. Class I and II ozone depleting substances in the Clean Air Act Amendments of 1990 by the Environmental Protection Agency (EPA) in the USA
3. Council Decision 88/540/EEC and 91/690/EEC Annex A, B and C (transitional substances) respectively.

Vishay Semiconductor GmbH can certify that our semiconductors are not manufactured with ozone depleting substances and do not contain such substances.

We reserve the right to make changes to improve technical design  
and may do so without further notice.

Parameters can vary in different applications. All operating parameters must be validated for each customer application by the customer. Should the buyer use Vishay Semiconductors products for any unintended or unauthorized application, the buyer shall indemnify Vishay Semiconductors against all claims, costs, damages, and expenses, arising out of, directly or indirectly, any claim of personal damage, injury or death associated with such unintended or unauthorized use.

Vishay Semiconductor GmbH, P.O.B. 3535, D-74025 Heilbronn, Germany  
Telephone: 49 (0)7131 67 2831, Fax number: 49 (0)7131 67 2423



## Disclaimer

All product specifications and data are subject to change without notice.

Vishay Intertechnology, Inc., its affiliates, agents, and employees, and all persons acting on its or their behalf (collectively, "Vishay"), disclaim any and all liability for any errors, inaccuracies or incompleteness contained herein or in any other disclosure relating to any product.

Vishay disclaims any and all liability arising out of the use or application of any product described herein or of any information provided herein to the maximum extent permitted by law. The product specifications do not expand or otherwise modify Vishay's terms and conditions of purchase, including but not limited to the warranty expressed therein, which apply to these products.

No license, express or implied, by estoppel or otherwise, to any intellectual property rights is granted by this document or by any conduct of Vishay.

The products shown herein are not designed for use in medical, life-saving, or life-sustaining applications unless otherwise expressly indicated. Customers using or selling Vishay products not expressly indicated for use in such applications do so entirely at their own risk and agree to fully indemnify Vishay for any damages arising or resulting from such use or sale. Please contact authorized Vishay personnel to obtain written terms and conditions regarding products designed for such applications.

Product names and markings noted herein may be trademarks of their respective owners.