



Muffin - MC24T3H - 032400 - No
 (Family) (Model) (Part #) (In Stock)

Electrical Specifications

Operating Voltage:	24 Volts
Voltage Range:	12 - 28 Volts
Power Supply:	6.7 Watts
Line Current:	0.28 Amps
Locked Rotor Current	0.86 Amps
Nominal Speed:	3700 RPM

Mechanical Specifications

Dimensions:	4.7 x 4.7 x 1.3 in
Weight	8.47 oz
Max Airflow @ 0 in H ₂ O	102.0 CFM
Max Pressure @ 0 CFM	0.350 in H ₂ O
Noise	47.8 dBA



Mechanical Drawing

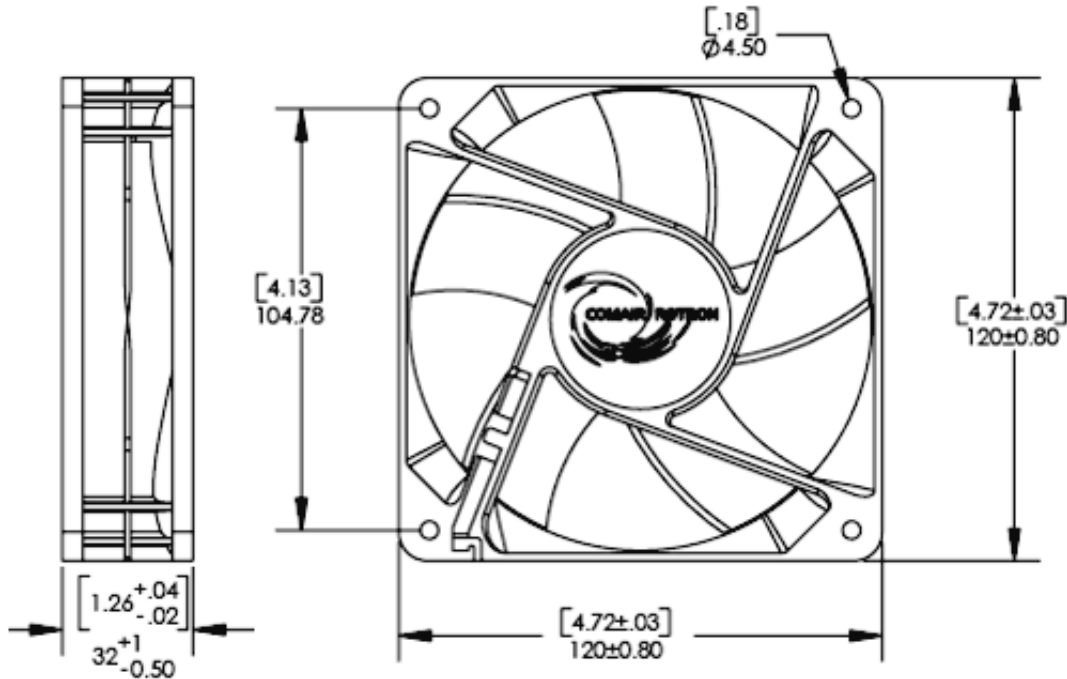

Comair Rotron, Inc.
 Phone: 619.651.2000
 sales@comairrotron.com

Comair Rotron Europe, Ltd.
 Phone: +44.1527.520525
 saleseurope@comairrotron.com

Comair Rotron Fan Company Ltd.
 Phone: +86.21.52260581
 salesasia@comairrotron.com

Print Date: Tuesday, April 3, 2012 at 23:32:05 - DC Fan Datasheet - Web Version 1.0 Rev. B



Fan Performance Curve

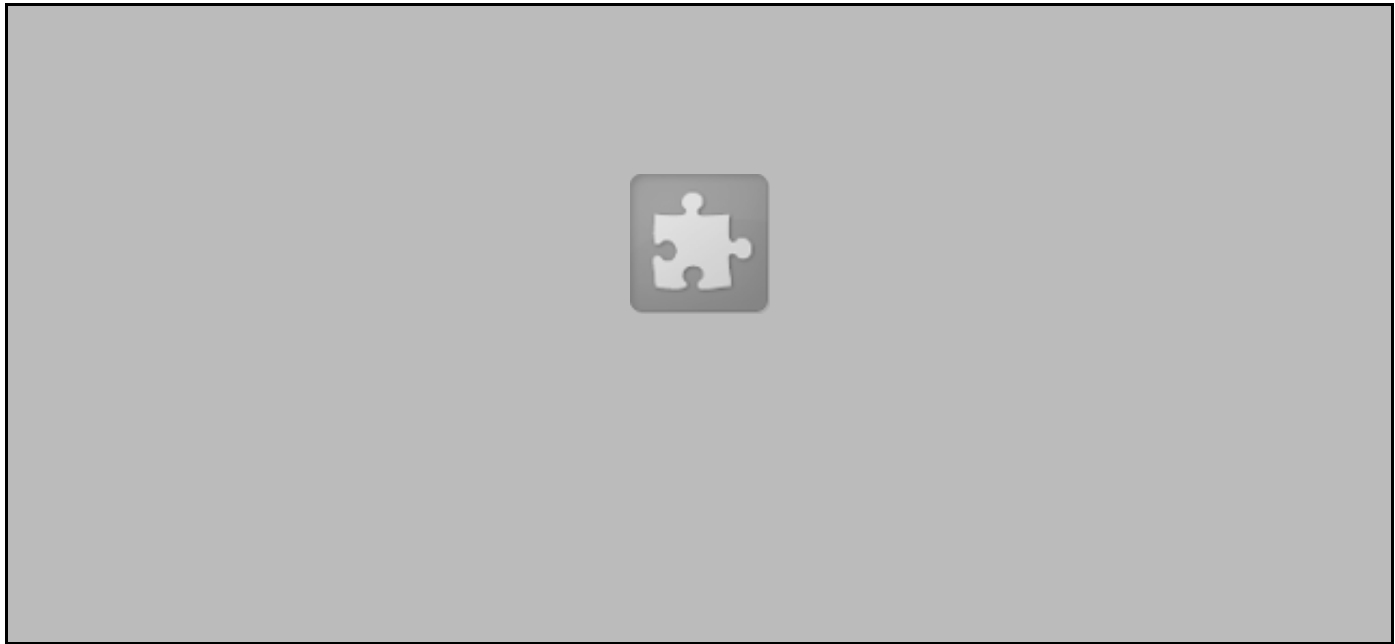

Fan Configuration Options

Muffin (Family)
 MC24T3H (Model) / **032400** (Part #)
 No (In Stock)
 305 mm [12 inch] Leads Thermistor on Zip Cord (Features)

Fan Speed: 3700 RPM
Fan Bearings: Ball Bearings
Fan Airflow Direction: Flow R (CCW Rotation)
Fan Termination: Leads

Fan Monitoring Options: No Fan Monitoring Options Selected

Fan Speed Control Option: ThermaPro-V Thermal Speed Control Option Selected

Environmental Protection Options: No Enviroshield Options Selected

Comair Rotron, Inc.
 Phone: 619.651.2000
 sales@comairrotron.com

Comair Rotron Europe, Ltd.
 Phone: +44.1527.520525
 saleseurope@comairrotron.com

Comair Rotron Fan Company Ltd.
 Phone: +86.21.52260581
 salesasia@comairrotron.com

Print Date: Tuesday, April 3, 2012 at 23:32:05 - DC Fan Datasheet - Web Version 1.0 Rev. B



Accessories (Click on part number for detailed drawing.)

477663
Mounting Clip

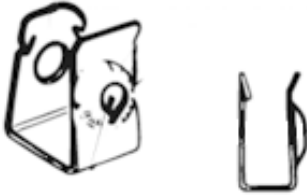

551590
Filter Assembly
Mounting Bracket Filter Frame
Filter Element
Fan Venturi Edge

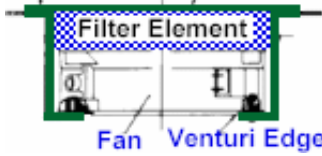

554148
Filter Guard Assembly

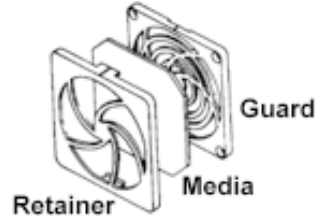

552934
Finger Guard

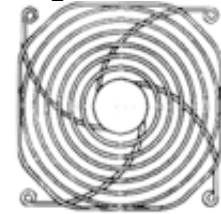

476042
Finger Guard

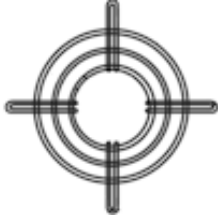

550481
Finger Guard

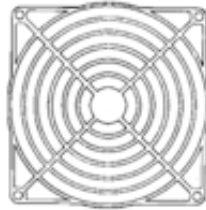

551147
Finger Guard

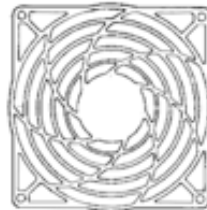

Comair Rotron, Inc.
Phone: 619.651.2000
sales@comairrotron.com

Comair Rotron Europe, Ltd.
Phone: +44.1527.520525
saleseurope@comairrotron.com

Comair Rotron Fan Company Ltd.
Phone: +86.21.52260581
salesasia@comairrotron.com

Print Date: Tuesday, April 3, 2012 at 23:32:05 - DC Fan Datasheet - Web Version 1.0 Rev. B