

ERD SERIES

10x10 SIZE SEALED CONSTRUCTION ROTARY TYPE

PIN OUT (3:3)



ERD 1xxxx
(Flat Type)

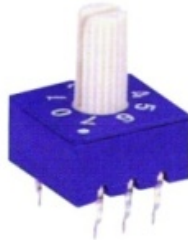

ERD 2xxxx
(Shaft Type)

PIN OUT(1:4)



ERD 4xxxx
(Flat Type)

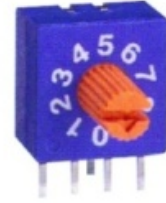

ERD 5xxxx
(Shaft Type)

FEATURES

- Molded-in terminals and fully sealed construction.
- Standard 2.54mm pin spacing.
- All plastics UL 94V-0 grade fire retardant.
- Reliable contact and long-term stability.
- Binary decimal (8 or 10 positions) and hexadecimal (16 positions), real and complementary codes available.
- Pin-out compatible with most of current equivalents.
- Gold plated contacts to ensure low contact resistance.

SPECIFICATIONS

1.ELECTRICAL

● Contact rating	switching	25mA, 24VDC
	non-switching	100mA
● Contact resistance		100mΩ Max.
● Insulation resistance		1000MΩ Min. at 100VDC
● Dielectric strength		250VAC Min. for 60seconds

2.MECHANICAL AND ENVIRONMENTAL

● Temperature rating	operating	-25°C to +70°C
	Storage	-40°C to +85°C
● Operation force		500 gf-cm Max.
● Mechanical life		2000 steps per position
● Vibration		10Hz-50Hz-10Hz for 6 Hrs
● Solderability (for through hole type)		after flux 230±5°C for 5±0.5 seconds,95% coverage
● Resistance to soldering heat (for through hole type)		260±5°C for 5±1 seconds.

- Reflow soldering heat for SMT type(reference only)

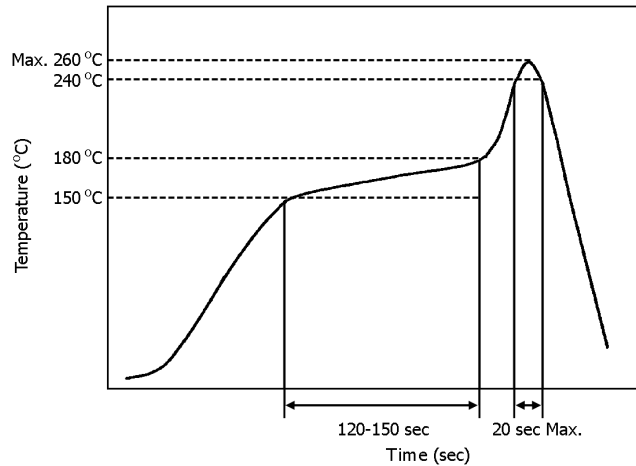

■ PART NUMBERING SYSTEM

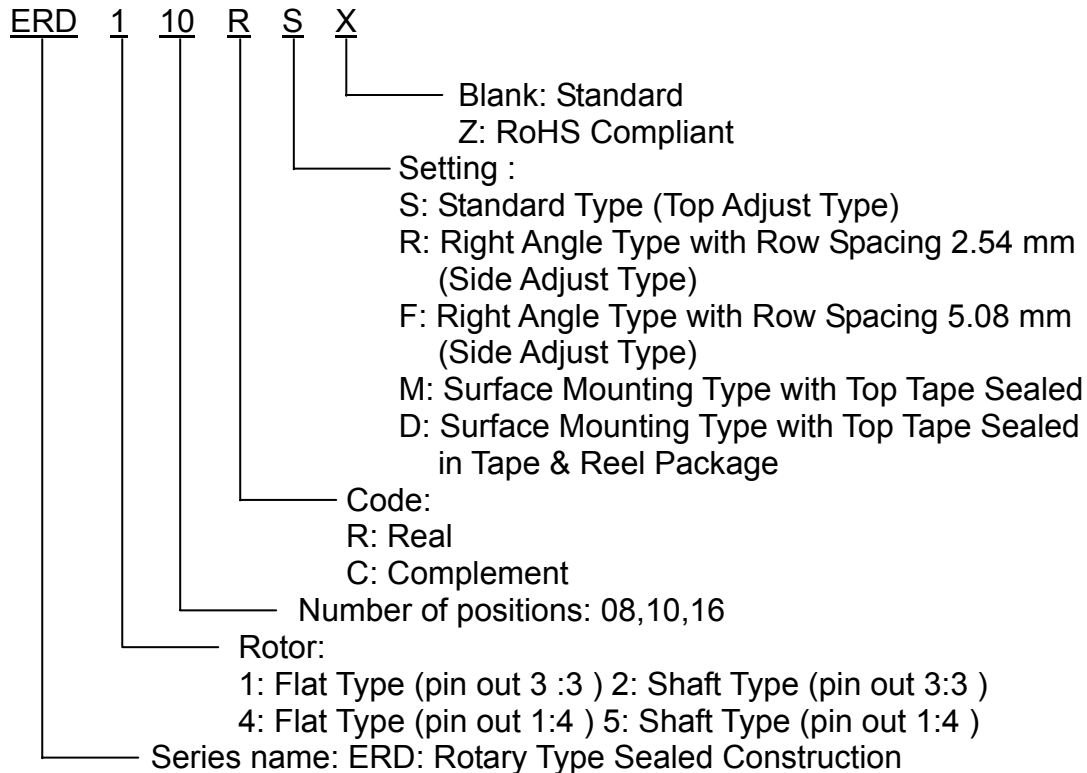

■ CODE

PIN NO.	POSITIONS															
	0	1	2	3	4	5	6	7	8	9	A	B	C	D	E	F
1	○	●	○	●	○	●	○	●	○	●	○	●	○	●	○	●
2	○	○	●	●	○	○	●	●	○	○	●	●	○	○	●	●
4	○	○	○	○	●	●	●	●	○	○	○	○	●	●	●	●
8	○	○	○	○	○	○	○	○	●	●	●	●	●	●	●	●

- ... Real Code
- Rotor color: White (3:3), Yellow (1:4)
- ... Complement Code
- Rotor color: Red (3:3), Orange (1:4)

CONSTRUCTION

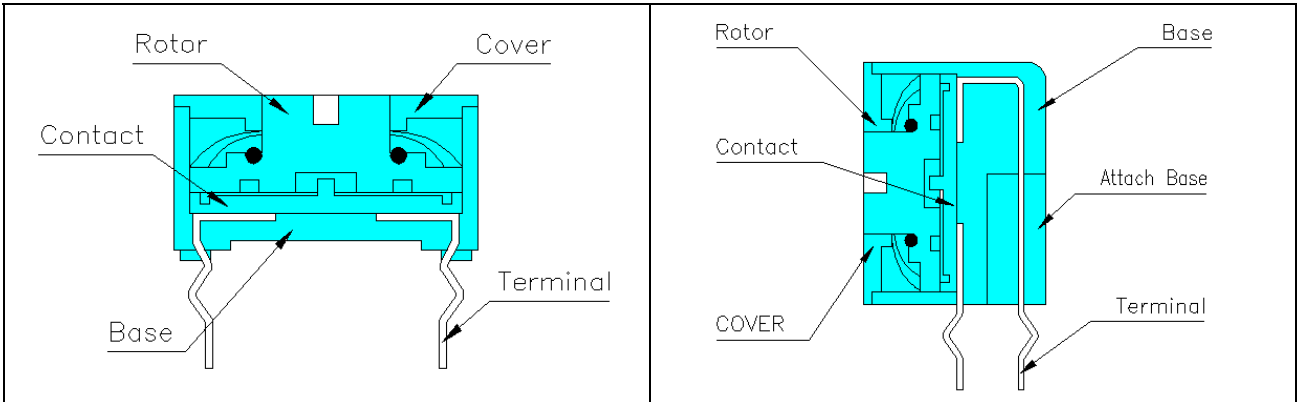

OPTIONS

1. Special marking available upon request
2. Shaft Cover
 - 418-80100(White 3:3)
 - 418-80200(Red 3:3)
 - 418-80300(Yellow 1:4)
 - 418-80400(Orange 1:4)

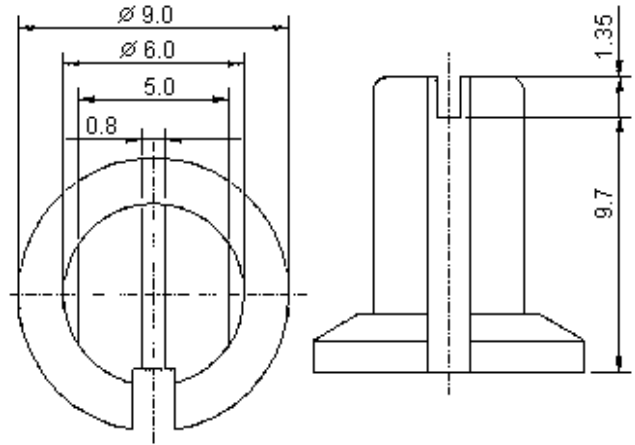
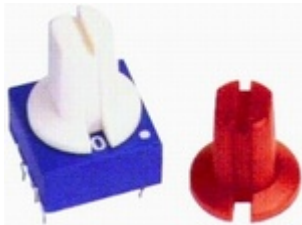

3. Tape & Reel Packaging (Per EIA STANDARD)

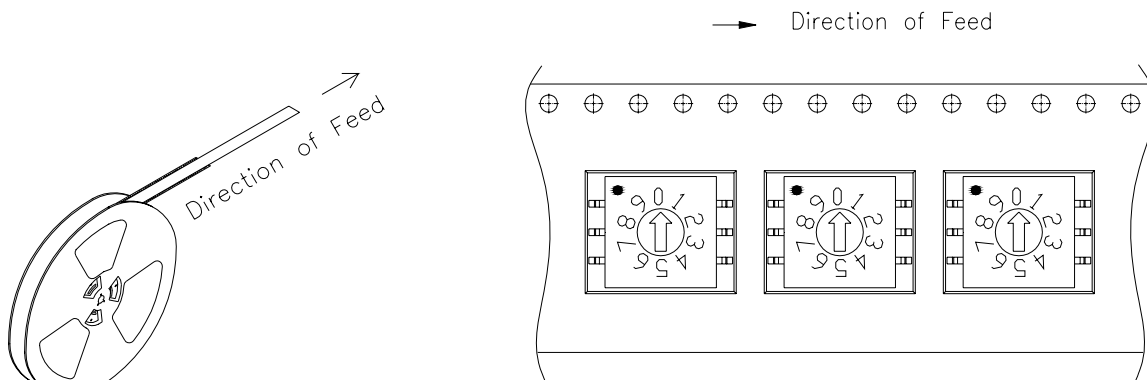

Each Reel contains 700 pcs switches with a 390mm minimum leader and a 160mm minimum trailer

INTRODUCTION to ECE ROTARY DIP SWITCH

SIZE	POSITIONS	CODE	PIN OUT	ROTOR	TYPE	PART NUMBER
10x10	8,10,16	REAL, COMPLEMENT	3:3	FLAT, SHAFT	STANDARD	ERD1xxxS,ERD2xxxS
					RIGHT ANGLE	ERD1xxxR/F,ERD2xxR/F
				FLAT	SMT	ERD1xxxM
					SMT IN T&R	ERD1xxxD
			1:4	FLAT, SHAFT	STANDARD	ERD4xxxS,ERD5xxxS
					RIGHT ANGLE	ERD4xxxR/F,ERD5xxxR/F
				FLAT	SMT	ERD4xxxM
					SMT IN T&R	ERD4xxxD

DIMENSIONS AND CIRCUITRY UNIT:mm(inch) **PIN OUT 3:3**

ERD1xxxS Flat Type

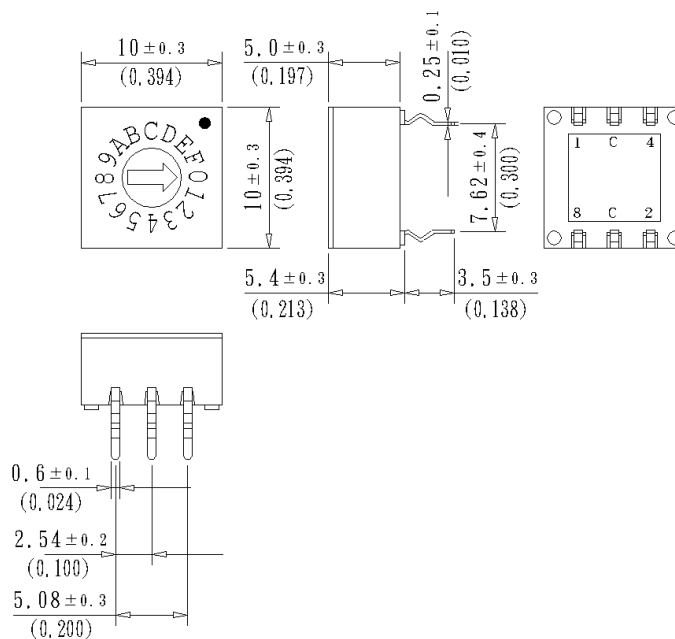

ERD2xxxS Shaft Type

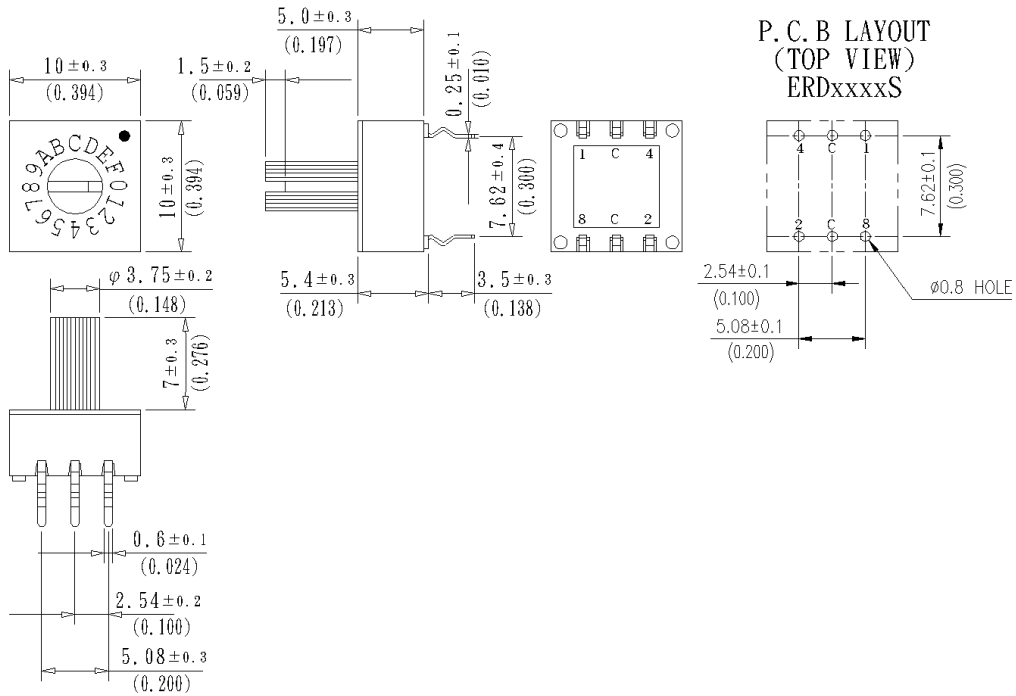

ERD1xxxR Flat Type

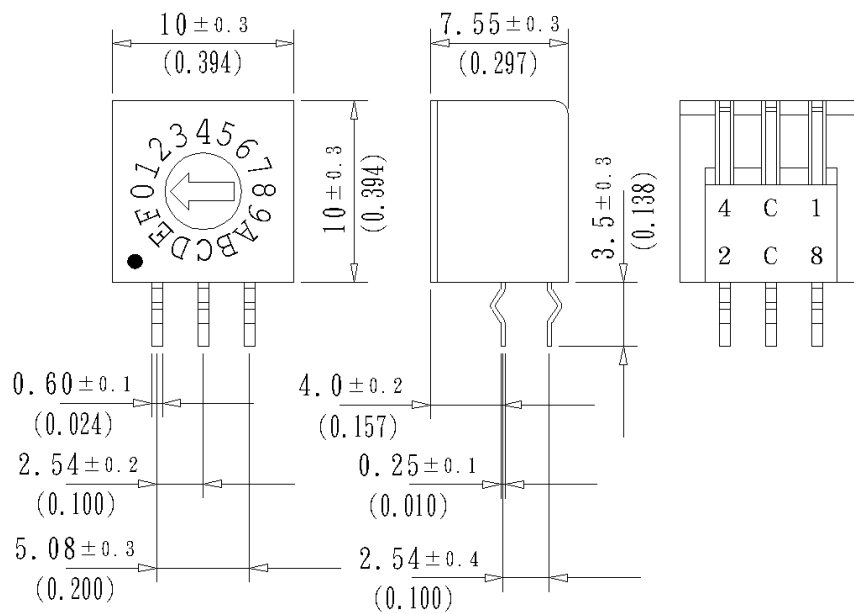

ERD2xxxR Shaft Type

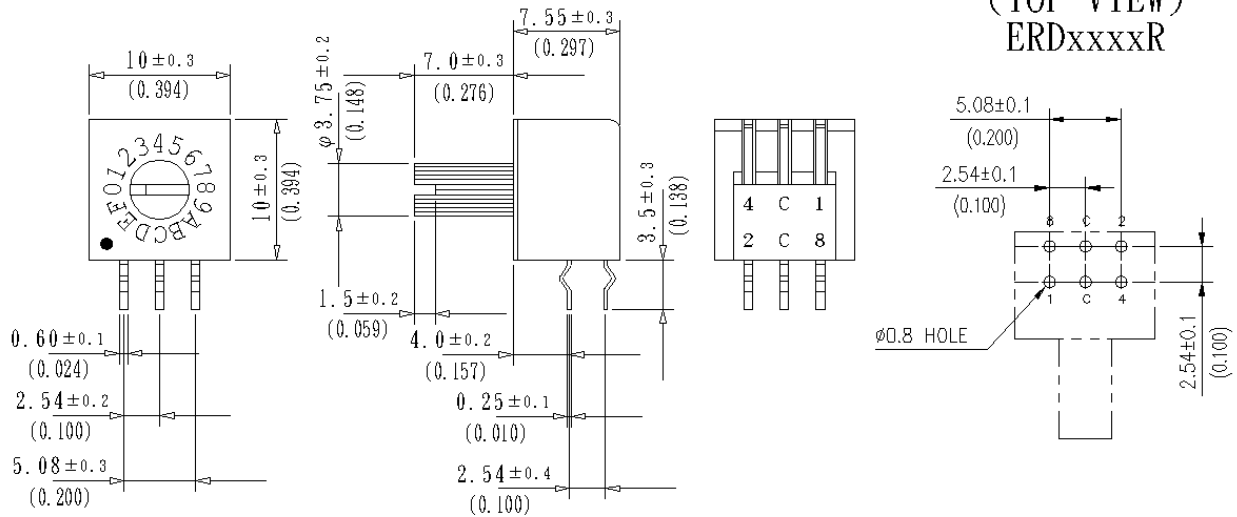

ERD1xxxF Flat Type

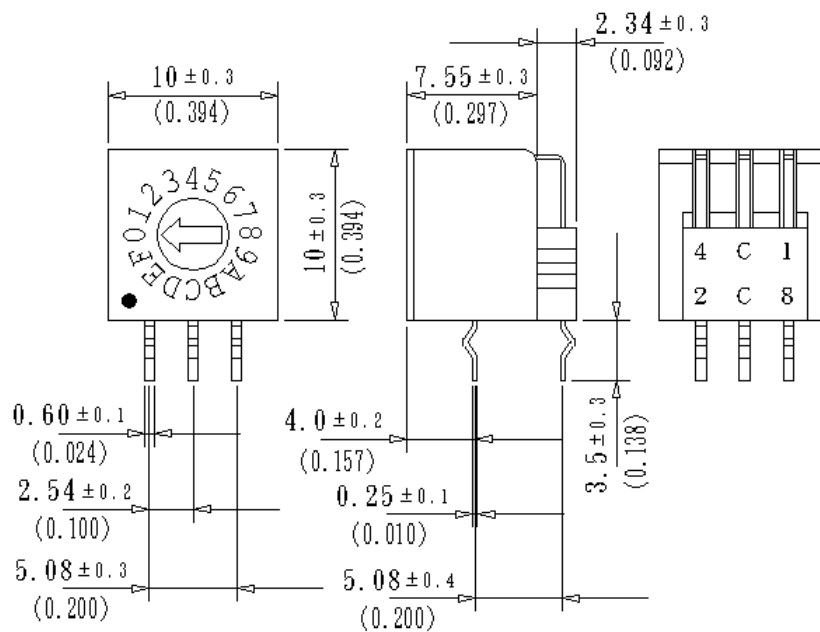

ERD2xxxF Shaft Type

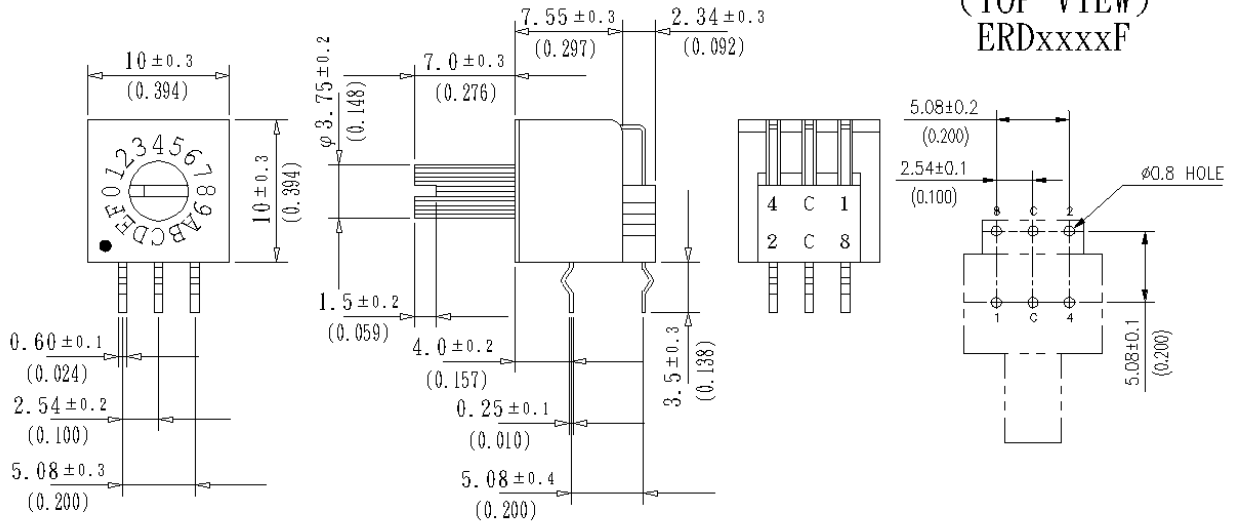

ERD1xxxM Flat Type

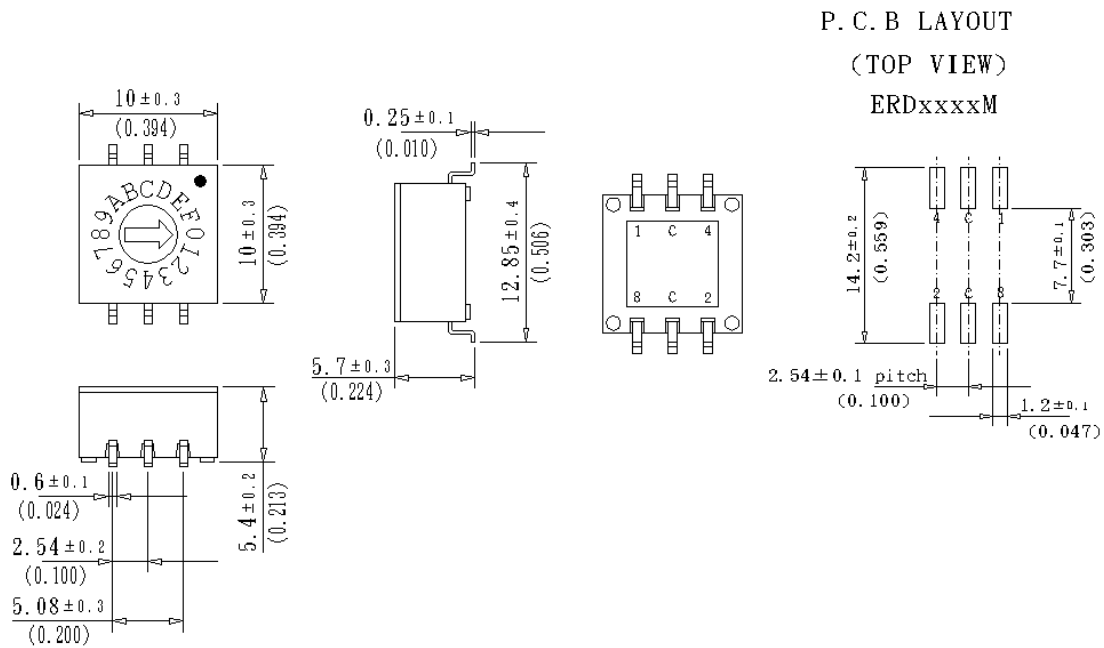

■ DIMENSIONS AND CIRCUITRY UNIT:mm(inch) PIN OUT 1:4

ERD4xxxS Flat Type

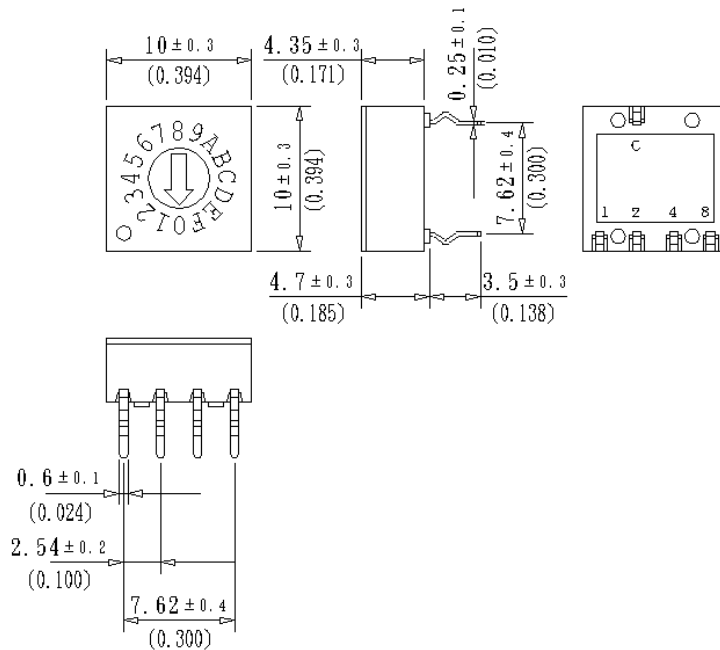

ERD5xxxS Shaft Type

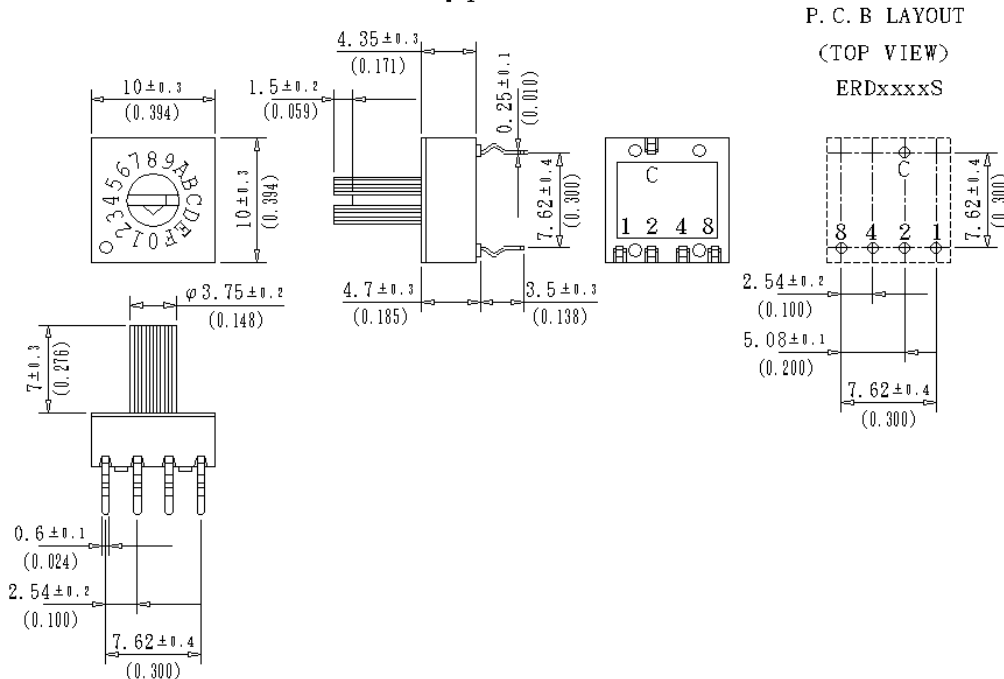

ERD4xxxR Flat Type

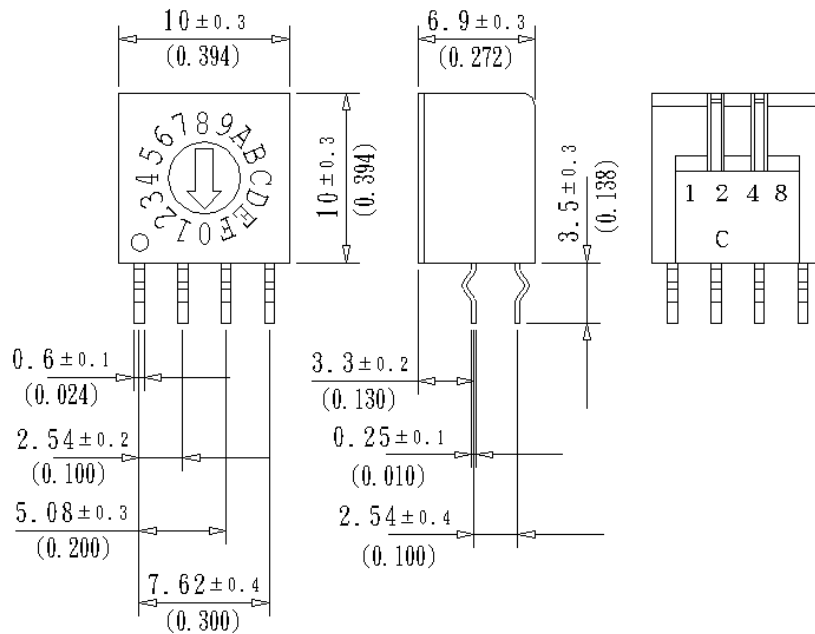

ERD5xxxR Shaft Type

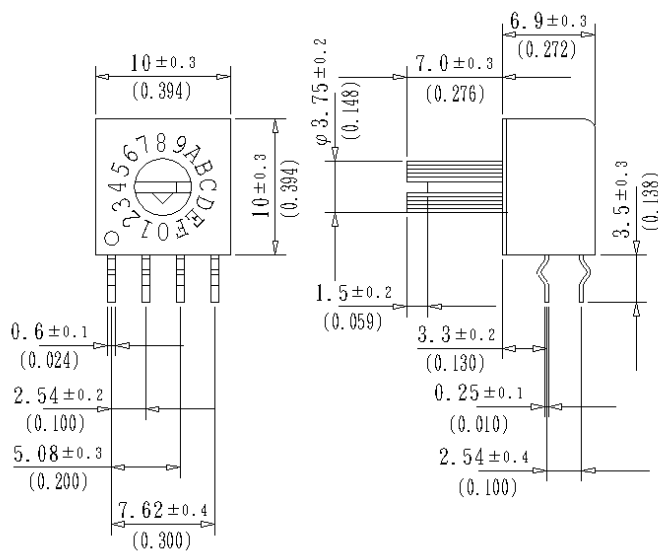

P. C. B LAYOUT (TOP VIEW) ERDxxxxR

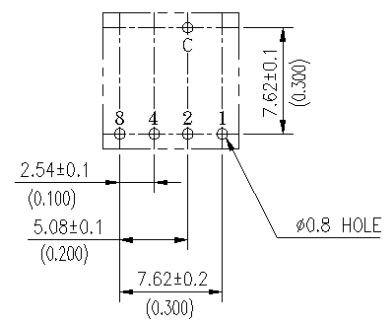

ERD4xxxF Flat Type

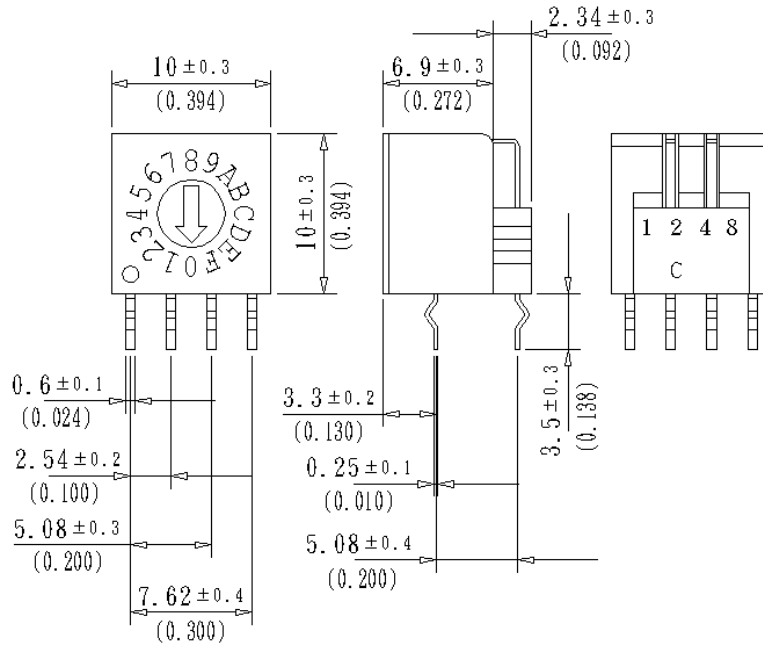

ERD5xxxF Shaft Type

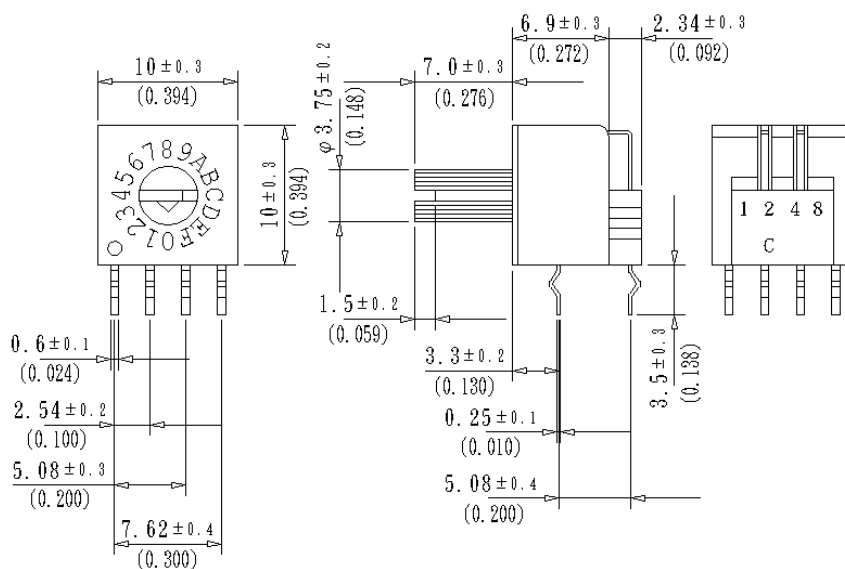

P. C. B LAYOUT (TOP VIEW) ERDxxxxF

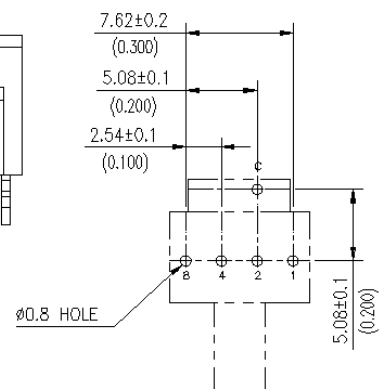

ERD4xxxM Flat Type

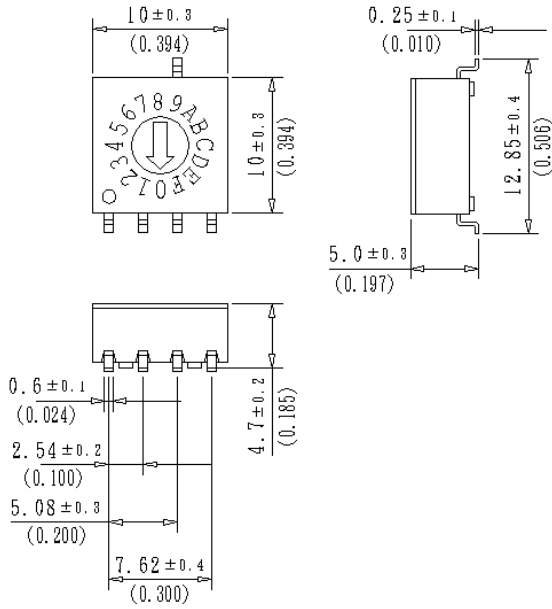

P. C. B LAYOUT

(TOP VIEW)
ERDxxxxM

