

# Plastic Optical Fiber and HCS® Fiber Cable and Connectors for Versatile Link

## Technical Data

**HFBR-RXXXXY Series (POF)**  
**HFBR-EXXXXY Series (POF)**  
**HFBR-HXXXXY Series (HCS)**  
**HFBR-VXXXXY Series (HCS)**

### Features

- Compatible with HP Versatile Link Family of Connectors and Fiber Optic Components
- 1 mm Diameter Plastic Optical Fiber (POF) in Two Grades: Low Cost Standard POF with 0.22 dB/m Typical Attenuation, or High Performance Extra Low Loss POF with 0.19 dB/m Typical Attenuation
- 200  $\mu$ m Diameter Hard Clad Silica (HCS®) Fiber with 8 dB/km Typical Attenuation, Riser or Plenum Rated Jackets, Superior Mechanical Strength

### Applications

- Industrial Data Links for Factory Automation and Plant Control
- Intra-System Links; Board-to-Board, Rack-to-Rack
- Telecommunications Switching Systems
- Computer-to-Peripheral Data Links, PC Bus Extension
- Proprietary LANs
- Digitized Video
- Medical Instruments

- Reduction of Lightning and Voltage Transient Susceptibility
- High Voltage Isolation

### Cable Description

The HFBR-R/EXXXXY series of plastic fiber optic cables are constructed of a single step-index fiber sheathed in a black polyethylene jacket. The duplex fiber consists of two simplex fibers joined with a zipcord web.

Standard attenuation and extra low loss POF cables are identical except for attenuation specifications.

The HFBR-H/VXXXXY series of hard clad silica fiber optic cables are constructed of a single step index pure silica HCS® fiber sheathed in a blue polyvinyl chloride jacket. The duplex fiber consists of two simplex fibers joined with a zipcord web. Riser and Plenum rated HCS® fiber cables are identical except for jacket materials.

Polyethylene jackets on all plastic fiber cables comply with UL VW-1 flame retardant specifications.

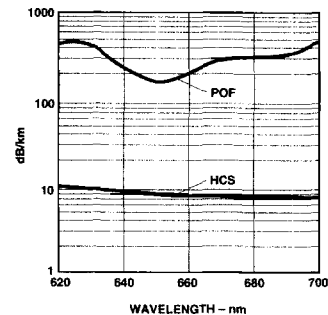
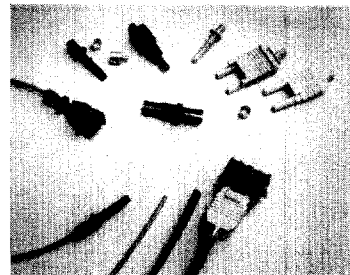

**Typical POF and HCS Attenuation**

PVC jackets on HCS® cables are either UL Riser rated or UL Plenum rated.

All series of cables are available in unconnected or connected options. Refer to the Ordering Guide for part number information.

HCS® is a registered trademark of SpecTran Corporation.

## Plastic Optical Fiber Specifications: HFBR-R/EXXYYY

### Absolute Maximum Ratings

Parameter		Symbol	Min.	Max.	Unit	Note
Storage and Operating Temperature		$T_{S,O}$	-55	+85	°C	
Recommended Operating Temperature		$T_O$	-40	+85	°C	
Installation Temperature		$T_I$	-20	+70	°C	1
Short Term Tensile Force	Single Channel	$F_T$		50	N	2
	Dual Channel	$F_T$		100	N	
Short Term Bend Radius		$r$	25		mm	3, 4
Long Term Bend Radius		$r$	35		mm	
Long Term Tensile Load		$F_T$		1	N	
Flexing				1000	Cycles	4

### Mechanical/Optical Characteristics, $T_A = -40$ to $+85^\circ\text{C}$ unless otherwise specified.

Parameter		Symbol	Min.	Typ. <sup>[5]</sup>	Max.	Unit	Condition
Cable Attenuation	Standard Cable, Type "R"	$\alpha_O$	0.15	0.22	0.27	dB/m	Source is HFBR-15XX (660 nm LED, 0.5 NA) $\ell = 50$ meters
	Extra Low Loss, Type "E"		0.15	0.19	0.23		
Reference Attenuation	Standard Cable, Type "R"	$\alpha_R$	0.12	0.19	0.24	dB/m	Source is 650 nm, 0.5 NA monochromator, $\ell = 50$ meters Note 7, Figure 1
	Extra Low Loss, Type "E"		0.12	0.16	0.19		
Numerical Aperture		NA	0.46	0.47	0.50		>2 meters
Diameter, Core and Cladding		$D_C$	0.94	1.00	1.06	mm	
Diameter, Jacket		$D_J$	2.13	2.20	2.27	mm	Simplex Cable
Propagation Delay Constant		$l/v$		5.0		ns/m	Note 6
Mass per Unit Length/Channel				5.3		g/m	Without Connectors
Cable Leakage Current		$I_L$		12		nA	50 kV, $\ell = 0.3$ meters
Refractive Index	Core	$n$		1.492			
	Cladding			1.417			

#### Notes:

1. Installation temperature is the range over which the cable can be bent and pulled without damage. Below  $-20^\circ\text{C}$  the cable becomes brittle and should not be subjected to mechanical stress.
2. Short Term Tensile Force is for less than 30 minutes.
3. Short Term Bend Radius is for less than 1 hour nonoperating.
4.  $90^\circ$  bend on 25 mm radius mandrel. Bend radius is the radius of the mandrel around which the cable is bent.
5. Typical data are at  $25^\circ\text{C}$ .
6. Propagation delay constant is the reciprocal of the group velocity for propagation delay of optical power. Group velocity is  $v=c/n$  where  $c$  is the velocity of light in free space ( $3 \times 10^8$  m/s) and  $n$  is the effective core index of refraction.
7. Note that  $\alpha_R$  rises at the rate of about  $0.0067$  dB/°C, where the thermal rise refers to the LED temperature changes above  $25^\circ\text{C}$ . Please refer to Figure 1 which shows the typical plastic optical fiber attenuation versus wavelength at  $25^\circ\text{C}$ .

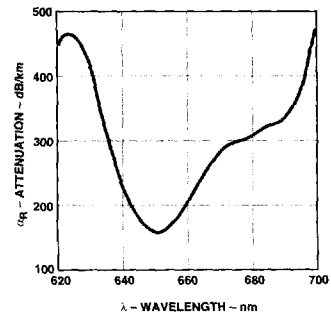

Figure 1. Typical POF Attenuation vs. Wavelength.

## Plastic Fiber Connector Styles

### Connector Description

Four connector styles are available for termination of plastic optical fiber: simplex, simplex latching, duplex and duplex latching. All connectors provide a snap-in action when mated to Versatile Link components. Simplex connectors are color coded to facilitate identification of transmitter and receiver connections. Duplex connectors are keyed so that proper orientation is ensured during insertion. If the POF cable/connector will be used at extreme operating temperatures or experience frequent and wide temperature cycling effects, the cable/connector attachment can be strengthened with an RTV adhesive (see Plastic Connectoring Instructions for more detail).

### SIMPLEX CONNECTOR STYLES

HFBR-4501/4511/4501B — Simplex

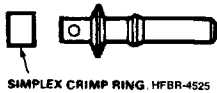

The simplex connector provides a quick and stable connection for applications that require a component-to-connector retention force of 8 Newtons (1.8 lb.). These connectors are available in gray (HFBR-4501), blue (HFBR-4511), or black (HFBR-4501B).

HFBR-4503/4513/4503B — Simplex Latching



The simplex latching connector is designed for rugged applications requiring a greater retention force — 80 Newtons (18 lb.) — than provided by a simplex nonlatching connector. When inserting the simplex latching connector into a module, the connector latch mechanism should be aligned with the top surface of the horizontal modules, or with the tall vertical side of the vertical modules. Misalignment of an inserted latching connector into either module will not result in a positive latch. The connector is released by depressing the rear section of the connector lever, and then pulling the connector assembly away from the module housing.

The simplex latching connector is available in gray (HFBR-4503), blue (HFBR-4513), or black (HFBR-4503B).

### DUPLEX CONNECTOR STYLES

HFBR-4506/4506B — Duplex

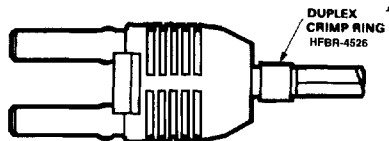

Duplex connectors provide convenient duplex cable termination and are keyed to prevent incorrect insertion into duplex configured modules. The duplex connector is compatible with dual combinations of horizontal or vertical Versatile Link components (e.g., two horizontal transmitters, two vertical receivers, a horizontal transmitter with a horizontal receiver, etc.). The duplex non-latching connector is available in parchment, off-white (HFBR-4506) or black (HFBR-4506B).

HFBR-4516/4516B — Duplex Latching

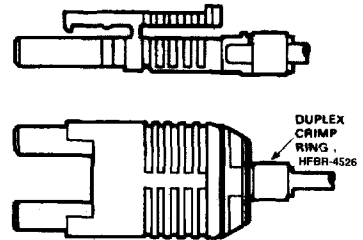

The duplex latching connector is designed for rugged applications requiring greater retention force than the nonlatching duplex connector. When inserting the duplex latching connector into a module, the connector latch mechanism should be aligned with the top surface of the dual combination of horizontal or vertical Versatile Link components. The duplex latching connector is available in gray (HFBR-4516) or black (HFBR-4516B).

### Feedthrough/Splice

HFBR-4505/4515/4506B Bulkhead Adapter

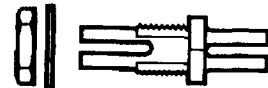

The HFBR-4505/4515 adapter mates two simplex connectors for panel/bulkhead feedthrough of HFBR-4501/4511 terminated plastic fiber cable. Maximum panel thickness is 4.1 mm (0.16 inch). This adapter can serve as a cable in-line splice using two simplex connectors. The adapters are available in gray (HFBR-4505), blue (HFBR-4515), and black (HFBR-4505B). This adapter is currently not compatible with POF duplex, POF simplex latching, or HCS connectors.

## Plastic Optical Fiber Connector Absolute Maximum Ratings

Parameter	Symbol	Min.	Max.	Unit	Note
Storage and Operating Temperature	$T_{S,O}$	-40	85	°C	1
Recommended Operating Temperature	$T_O$	-40	85	°C	1
Installation Temperature	$T_I$	0	70	°C	1
Nut Torque HFBR-4505/4515 Adapter	$T_N$		0.7	N-m	2
			100	OzF-in.	

### Notes:

- Storage and Operating Temperatures refer to the ranges over which the connectors can be used when not subjected to mechanical stress. Installation Temperature refers to the ranges over which connectors may be installed onto the fiber and over which connectors can be connected and disconnected from transmitter and receiver modules.
- Recommended nut torque is 0.57 N-m.

## Plastic Optical Fiber Connector Mechanical/Optical Characteristics

$T_A = -40$  to  $+85^\circ\text{C}$ , Unless Otherwise Specified.

Parameter	Part Number	Symbol	Min.	Typ. <sup>(1)</sup>	Max.	Units	Temp. °C	Note
Retention Force, Connector to Versatile Link Transmitters and Receivers	Simplex, HFBR-4501/4511	$F_{R-C}$	7 3	8		N	+25 -40 to +85	2
	Simplex Latching, HFBR-4503/4513		47 11	80			+25 -40 to +85	
	Duplex, HFBR-4506		7 4	12			+25 -40 to +85	
	Duplex Latching, HFBR-4516		50 15	80			+25 -40 to +85	
Tensile Force, Connector to Cable	Simplex, HFBR-4501/4511	$F_T$	8.5	22		N		3
	Simplex Latching, HFBR-4503/4513		8.5	22				
	Duplex, HFBR-4506		14	35				
	Duplex Latching, HFBR-4516		14	35				
Adapter Connector to Connector Loss	HFBR-4505/4515 with HFBR-4501/4511	$\alpha_{CC}$	0.7	1.5	2.8	dB	25	4, 5
Retention Force Connector to Adapter	HFBR-4505/4515 with HFBR-4501/4511	$F_{R-B}$	7	8		N		
Insertion Force, Connector to Versatile Link Transmitters and Receivers	Simplex, HFBR-4501/4511	$F_I$		8	30	N		6
	Simplex Latching, HFBR-4503/4513			16	35			
	Duplex, HFBR-4506			13	46			
	Duplex Latching HFBR-4516			22	51			

### Notes:

- Typical data are at  $+25^\circ\text{C}$ .
- No perceivable reduction in retention force was observed after 2000 insertions. Retention force of non-latching connectors is lower at elevated temperatures. Latching connectors are recommended for applications where a high retention force at high temperatures is desired.
- For applications where frequent temperature cycling over temperature extremes is expected, please contact Hewlett-Packard for alternate connecting techniques.
- Minimum and maximum limit for  $\alpha_{CC}$  for  $0^\circ\text{C}$  to  $+70^\circ\text{C}$  temperature range. Typical value of  $\alpha_{CC}$  is at  $+25^\circ\text{C}$ .
- Factory polish or field polish per recommended procedure.
- Destructive insertion force was typically at 178 N (40 lb.).

## Step-by-Step Plastic Cable Connectoring Instructions

The following step-by-step guide describes how to terminate plastic fiber optic cable. It is ideal for both field and factory installation. Connectors can be easily installed on cable ends with wire strippers, cutters and a crimping tool.

Finishing the cable is accomplished with the Hewlett-Packard HFBR-4593 Polishing Kit, consisting of a Polishing Fixture, 600 grit abrasive paper and 3  $\mu$ m pink lapping film (3M Company, OC3-14). The connector can be used immediately after polishing.

Materials needed for plastic fiber termination are:

1. Hewlett-Packard Plastic Optical Fiber Cable (Example: HFBR-RUS500, HFBR-RUD500, HFBR-EUS500, or HFBR-EUD500)
2. Industrial Razor Blade or Wire Cutters
3. 16 Gauge Latching Wire Strippers (Example: Ideal Stripmaster™ type 45-092).
4. HFBR-4597 Crimping Tool
5. HFBR-4593 Polishing Kit
6. One of the following connectors:
  - a) HFBR-4501/4503 Gray Simplex/Simplex Latching Connector and HFBR-4525 Simplex Crimp Ring
  - b) HFBR-4511/4513 Blue Simplex/Simplex Latching Connector and HFBR-4525 Simplex Crimp Ring
  - c) HFBR-4506 Parchment (off-white) Duplex Connector and HFBR-4526 Duplex Crimp Ring
  - d) HFBR-4516 Gray Latching Duplex Connector and HFBR-4526 Duplex Crimp Ring

### Step 1

The zip cord structure of the duplex cable permits easy separation of the channels. The channels should be separated approximately 50 mm (2.0 in) back from the ends to permit connectoring and polishing.

After cutting the cable to the desired length, strip off approximately 7 mm (0.3 in.) of the outer jacket with the 16 gauge wire strippers. Excess webbing on the duplex cable may have to be trimmed to allow the simplex or simplex latching connector to slide over the cable.

When using the duplex connector and duplex cable, the separated duplex cable must be stripped to equal lengths on each cable. This allows easy and proper seating of the cable into the duplex connector.

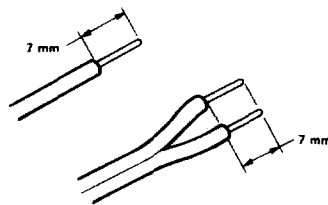

### Step 2

Place the crimp ring and connector over the end of the cable; the fiber should protrude about 3 mm (0.12 in.) through the end of the connector. Carefully position the ring so that it is entirely on the connector with the rim of the crimp ring flush with the connector, leaving a small space between the crimp ring and the flange. Then crimp the ring in place with the crimping tool. One crimp tool is used for all POF connector crimping requirements.

For applications with extreme temperature operation or frequent temperature cycling, improved connector to cable attachment can be achieved with the use of an RTV (GE Company, RTV-128 or Dow Corning 3145-RTV) adhesive. The RTV is placed into the connector prior to insertion of the fiber and the fiber is crimped normally. The connector can be polished after the RTV has cured and is then ready for use.

**Note:** By convention, place the gray connector on the transmitter cable end and the blue connector on the receiver cable end to maintain color coding (different color connectors are mechanically identical).

Simplex connector crimp rings cannot be used with duplex connectors and duplex connector crimp rings cannot be used with simplex connectors because of size differences. The simplex crimp has a dull luster appearance; the duplex ring is glossy and has a thinner wall.

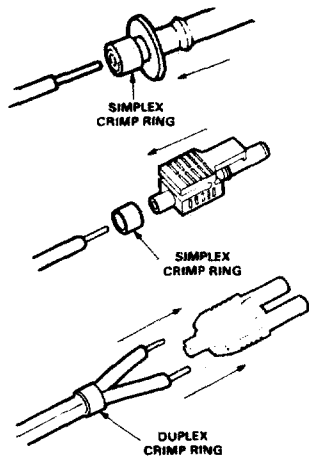

### Step 3

Any excess fiber protruding from the connector end may be cut off; however, the trimmed fiber should extend at least 1.5 mm (0.06 in) from the connector end.

Insert the connector fully into the polishing fixture with the trimmed fiber protruding from the bottom of the fixture. This plastic polishing fixture can be used to polish two simplex connectors or simplex latching connectors simultaneously, or one duplex connector.

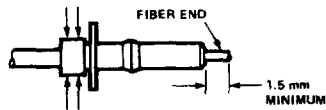

**Note:** The four dots on the bottom of the polishing fixture are wear indicators. Replace the polishing fixture when any

dot is no longer visible. Typically, the polishing fixture can be used 10 times; 10 duplex connectors or 20 simplex connectors, two at a time.

Place the 600 grit abrasive paper on a flat smooth surface, pressing down on the connector, polish the fiber and the connector using a figure eight pattern of strokes until the connector is flush with the bottom of the polishing fixture. Wipe the connector and fixture with a clean cloth or tissue.

### Step 4

Place the flush connector and polishing fixture on the dull side of the 3  $\mu$ m pink lapping film and continue to polish the fiber and connector for approximately 25 strokes. The fiber end should be flat, smooth and clean.

This cable is now ready for use.

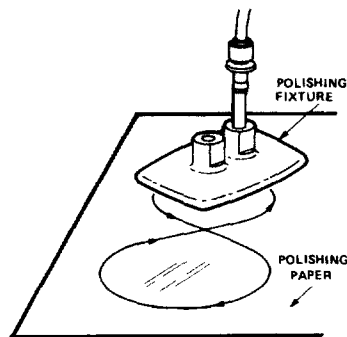

**Note:** Use of the pink lapping film fine polishing step results in approximately 2 dB improvement in coupling performance of either a transmitter-receiver link or a bulkhead/splice over a 600 grit polish alone. This fine polish is comparable to the Hewlett-Packard factory polish. The fine polishing step may be omitted where an extra 2 dB of optical power is not essential, as with short link lengths. Proper polishing of the tip of the fiber/connector face results in a tip diameter between 2.5 mm (0.098 in.) minimum and 3.2 mm (0.126 in.) maximum.

### HFBR-4593 Polishing Kit

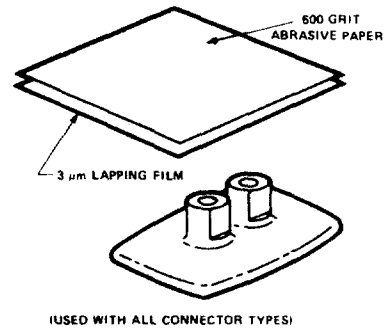

## Hard Clad Silica Fiber Specifications: HFBR-H/VXXXXY

### Absolute Maximum Ratings

Parameter		Symbol	Min.	Max.	Unit	Note
Storage/Operating Temperature		$T_{S,O}$	-40	85	°C	
Recommended Operating Temperature		$T_O$	-40	85	°C	
Installation Temperature		$T_I$	-20	85	°C	1
Short Term Tensile Force	Single Channel	$F_T$		101	N	2
	Dual Channel	$F_T$		202	N	2
Short Term Bend Radius		$r$	9		mm	3, 4
Long Term Bend Radius		$r$	15		mm	
Long Term Tensile Load		$F_T$		21	N	
Flexing				50,000	Cycles	4

### Mechanical/Optical Characteristics, $T_A = -40$ to $+85^\circ\text{C}$

Parameter		Symbol	Min.	Typ. <sup>[5]</sup>	Max.	Unit	Condition
Cable Attenuation	HCS® Cable	$\alpha_O$	5	7	10	dB/km	Source is HFBR-15X7 (650 nm LED, 0.5 NA) 0 to $+70^\circ\text{C}$
Cable Attenuation	HCS® Cable	$\alpha_O$	5	7	12	dB/km	$-40$ to $+85^\circ\text{C}$
Reference Attenuation	HCS® Cable	$\alpha_R$	6.0	8.0	10.0	dB/km	Source is 650 nm, 0.37 NA monochromator $-40$ to $+85^\circ\text{C}$
Numerical Aperture		NA	0.35	0.37	0.39		$\ell = 2$ meters
Diameter, Core		$D_{CORE}$	196	200	204	$\mu\text{m}$	
Diameter, Cladding		$D_{CLAD}$	220	230	230	$\mu\text{m}$	
Diameter, Buffer		$D_{BUFF}$	470	500	530	$\mu\text{m}$	
Diameter, Jacket		$D_J$	2.1	2.2	2.3	mm	Simplex Cable
Propagation Delay Constant		$l/v$		4.8		ns/m	Note 6
Mass per Unit Length/Channel				6.1		g/m	Without Connectors
Refractive Index	Core	$n$		1.457			
	Cladding			1.407			

#### Notes:

1. Installation temperature is the range over which the cable can be bent and pulled without damage. Below  $-20^\circ\text{C}$  the cable becomes brittle and should not be subjected to mechanical stress.
2. Less than 1 hour.
3. Less than 1 hour, non-operating.
4.  $90^\circ$  bend on 9 mm radius.
5. Typical data are at  $+25^\circ\text{C}$ .
6. Propagation delay constant is the reciprocal of the group velocity for propagation delay of optical power. Group velocity is  $v = c/n$ , where  $c$  is the velocity of light in free space ( $3 \times 10^8$  m/s) and  $n$  is the effective core index of refraction.

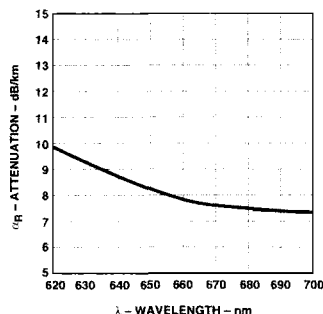

Figure 1. Typical HCS Attenuation vs. Wavelength.

## Hard Clad Silica Optical Fiber Connector Styles

### Simplex Connector Style, HFBR-4521

The simplex connector provides a quick and stable connection for applications that require a component to provide a retention force of 8 Newtons (1.8 lb.). This connector is available only in black.

## Hard Clad Silica Glass Optical Fiber Connector

### Absolute Maximum Ratings

Parameter	Symbol	Min.	Max.	Unit	Note
Storage and Operating Temperature	$T_{S,O}$	-40	85	°C	1
Recommended Operating Temperature	$T_O$	-40	85	°C	
Installation Temperature	$T_A$	0	85	°C	

**Note:**

- Storage and Operating Temperatures refer to the ranges over which the connectors can be used when not subjected to mechanical stress. Installation Temperature refers to the ranges over which connectors may be installed onto the fiber and over which connectors can be connected and disconnected from transmitter and receiver modules.

## Hard Clad Silica Glass Optical Fiber Connector

Mechanical/Optical Characteristics;  $T_A = -40$  to  $+85^\circ\text{C}$

Parameter	Part Number		Sym.	Min.	Typ. <sup>[1]</sup>	Max.	Units	Note
Retention Force Connector to Versatile Link Transmitters and Receivers	Simplex	HFBR-4521	$F_{R-C}$	3	8		N	2
Tensile Force Connector to Cable	Simplex	HFBR-4521	$F_T$	40	45		N	
Insertion Force Connector to Versatile Link Transmitters and Receivers	Simplex	HFBR-4521	$F_I$		8	30	N	3

**Notes:**

- Typical data are at  $+25^\circ\text{C}$ .
- No perceivable reduction in retention force was observed after 2000 insertions.
- Destructive insertion forces was typically at 178 N (40 lb.).



## Instructions for Step-by-Step Connector Installation for HCS® Cable



The following step-by-step guide describes how to terminate hard clad silica fiber optic cable. It is ideal for both field and factory installation. Connecting the cable is accomplished with the Hewlett-Packard HFBR-4521 Crimp and Cleave Kit consisting of a Cable Stripper Tool, Fiber Stripper Tool, Crimp Tool, and Diamond Cleave Tool. No adhesive material is needed to secure the cable in the connector, and the connector can be used immediately after cleaving. Connectors may be easily installed on the cable ends with the Crimp and Cleave Kit.

Materials needed for the terminating procedure are:

1. Hewlett-Packard HCS® Fiber Optic Cable: (Example: HFBR-HUS500, HFBR-HUD500, HFBR-VUS500)
2. HFBR-4584 Crimp and Cleave Kit
3. HFBR-4521 Black Simplex Connector and Crimp Ring (HFBR-4527)

### Step 1 - Strip Outer Jacket

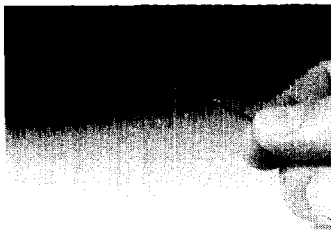

The zipcord structure of the duplex cable permits easy separation of the channels. The channels should be separated approximately 75 mm (3.0 in) back from the ends to permit connecting and cleaving. After cutting the cable to the desired length, strip off approximately 75 mm (3 in) of the outer jacket with the cable stripper tool, selecting the 1.6 cutting hole labeled on the cable stripper tool. This is done by applying a quick squeezing action to cut the cable jacket. Remove the cut cable jacket portion.

### Step 2 - Install Crimp Ring (HFBR-4527) to Fiber



Place the crimp ring over the end of the cable and rest the larger end against the unstripped cable jacket. Selecting the smaller crimp hole (front die nest), align the crimp ring in the crimp tool jaws and fully squeeze the tool handles together and release. This crimps the crimp ring to the fiber buffer.

### Step 3 - Strip Buffer

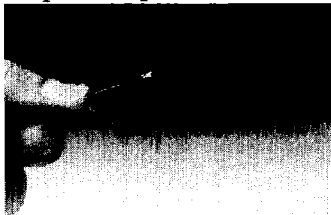

Insert the stripped cable through the guide hole of the fiber

stripper tool, inserting the crimp ring until it is fully seated in the guide tube. Holding the unstripped cable securely, squeeze the handles of the fiber stripper to cut the fiber buffer and pull straight to slightly separate the buffer.

Release the fiber stripper handles, remove the tool and carefully slide the buffer off the fiber by hand. Inspect the fiber for cladding damage (i.e., white dusty appearance). If damage has occurred, cut the damaged portion of the fiber and repeat the Strip Outer Jacket procedure. If the fiber stripper tool blade is worn, replace the tool immediately.

### Step 4 - Install Ferrule (Connector)

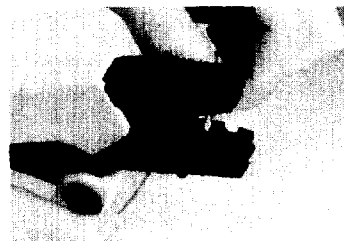

Slide the ferrule onto the fiber and into the crimp ring, carefully aligning the ferrule fully within the crimp ring. The fiber should protrude at least 35 mm (1.4 in) through the end of the ferrule. Selecting the large hole on the crimp tool (rear die nest), crimp the ring to the ferrule by fully squeezing the crimp tool handles together and releasing.

### Step 5 - Cleave Fiber



Carefully insert the ferrule into the slot on the diamond cleave tool until the ferrule rests securely in the cleave tool connector adapter.

Check to see that the fiber is positioned between the two fiber clamps and that the connector face is in proximity to the cleaving blade. If the ferrule or the fiber is not positioned correctly, remove the cable assembly and reinsert the ferrule.

Holding the cleave tool horizontally, grip the handle, leaving the index finger free. Release the ferrule, and, using the index finger, slowly depress the cleave

tool trigger until the trigger is completely down. This motion activates the fiber clamp and the diamond cleave blade to complete the fiber termination; the ferrule will snap back slightly after the cleave process. Remove the cleaved ferrule (connector assembly) from the adapter slot

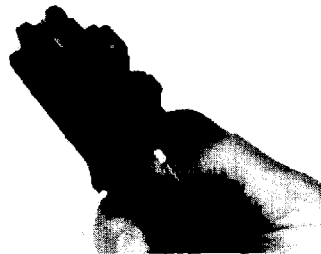

and release the cleave tool trigger. Remove the fiber remnant from the cleave tool fiber clamps and dispose of properly.

The fiber end should be flat, smooth and clean. Repeat this process for the other end of the cable, and the cable is now ready for use.

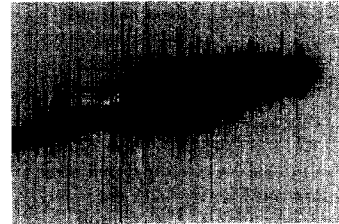

---

## Ordering Guide for POF and HCS Connectors and Accessories

### Plastic Optical Fiber Connectors

HFBR-4501	Gray Simplex Connector/Crimp Ring
HFBR-4511	Blue Simplex Connector/Crimp Ring
HFBR-4501B	Black Simplex Connector/Crimp Ring
HFBR-4503	Gray Simplex Latching Connector with Crimp Ring
HFBR-4513	Blue Simplex Latching Connector with Crimp Ring
HFBR-4503B	Black Simplex Latching Connector with Crimp Ring
HFBR-4506	Parchment Duplex Connector with Crimp Ring
HFBR-4506B	Black Duplex Connector with Crimp Ring
HFBR-4516	Gray Duplex Latching Connector with Crimp Ring
HFBR-4516B	Black Duplex Latching Connector with Crimp Ring
HFBR-4505	Gray Adapter (Bulkhead/Feedthrough)
HFBR-4515	Blue Adapter (Bulkhead/Feedthrough)
HFBR-4505B	Black Adapter (Bulkhead/Feedthrough)

### Plastic Optical Fiber Accessories

HFBR-4525	1000 Simplex Crimp Rings
HFBR-4526	500 Duplex Crimp Rings
HFBR-4593	Polishing Kit (one polishing tool, two pieces 600 grit abrasive paper, and two pieces 3 $\mu$ m pink lapping film)
HFBR-4597	Plastic Fiber Crimping Tool

### HCS® Fiber Connectors

HFBR-4521	Black Simplex Connector/Crimp Ring
-----------	------------------------------------

### HCS® Fiber Accessories

HFBR-4527	100 Simplex Crimp Rings
HFBR-4584	Crimp and Cleave Termination Kit (one Fiber Strip tool, one Cable Strip tool, one Crimp tool, one Scissors and one Diamond Cleave Tool)

## Ordering Guide for POF and HCS Cable

Four steps are required to determine the proper part number for a desired cable.

### Step 1

#### Select the cable type.

POF: Standard (**R**) or Extra Low Loss (**E**) Attenuation Cable.

HCS: Riser (**H**) or Plenum (**V**) rated cable.

### Step 2

#### Select the connector style.

POF: Simplex, Simplex Latching, Duplex, or Duplex Latching.

HCS: Simplex only (non-latching).

### Step 3

#### Select Simplex or Duplex cable.

### Step 4

#### Determine the cable length.

To determine the appropriate part number, select the letter corresponding to your selection and fill in the appropriate

information, as in the chart below.

#### For Example:

HFBR-RUD500 is a Standard Attenuation, Unconnected, Duplex, 500 meter cable.

HFBR-ELS001 is an Extra Low Loss Attenuation, Latching Simplex Connected, Simplex, 1 meter cable.

HFBR-RMD010 is a Standard Attenuation, Standard Duplex Connected, Duplex, 10 meter cable.

HFBR-RND100 is a Standard Attenuation, Standard Simplex Connected, Duplex, 100 meter cable.

#### Cable Length Tolerances:

The plastic cable length tolerances are: +10%/-0%.

**Note:** 0.1 meter Standard Attenuation Simplex lengths are available: 0.5 meter Standard Attenuation Simplex and Duplex lengths are also available. The

lengths are ordered as HFBR-xxx1DM or HFBR-xxx5DM. Cables of 1 to 10 meter lengths in 1 decimeter increments are also available. This cable is ordered as HFBR-xxxxyD where "yy" is the length of the cable. For example, a 1.5 meter Standard Attenuation, Standard Simplex Connected, Simplex cable would be ordered as HFBR-RNS15D.

**NOTE:** By convention, pre-connected simplex POF cables have gray and blue colored connectors on the opposite ends of the same fiber; although oppositely colored, the connectors are mechanically identical. For duplex POF cables with simplex connectors, the same rule applies to each fiber and adjacent terminations use complimentary colored connectors. For duplex POF cables with duplex connectors similar rules apply using color coded markings on the duplex fiber cable. Pre-connected simplex HCS cables have identically colored BLACK connectors on both ends of the fiber.

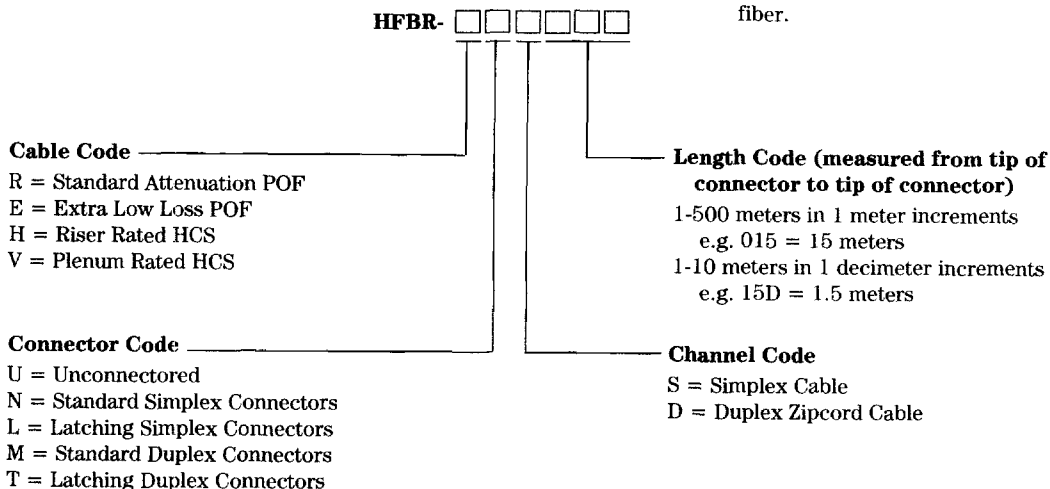

# Connector Applications

## Attachment to Hewlett-Packard Versatile Link Fiber Optic Components

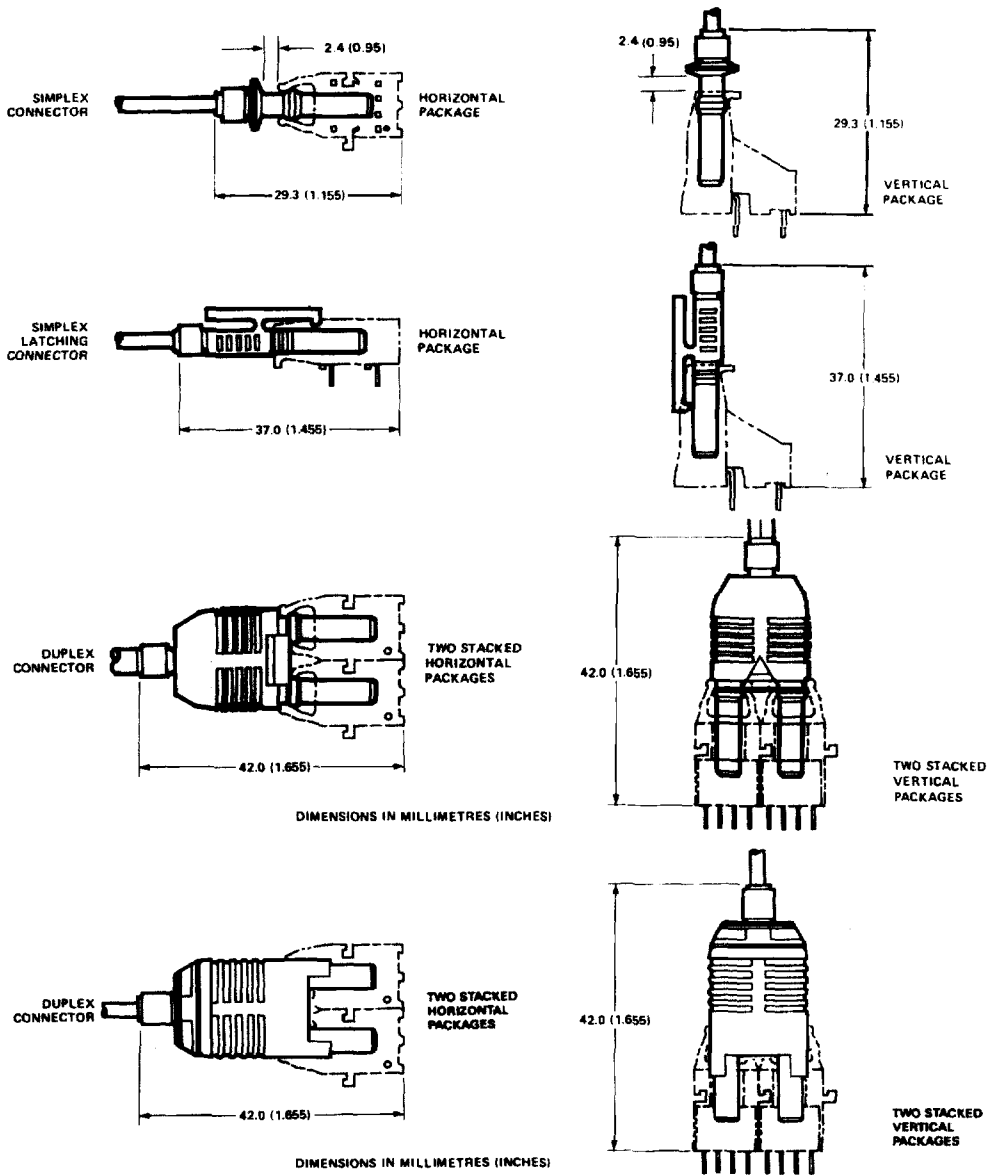

## Bulkhead Feedthrough or Panel Mounting for HFBR-4501/4511/4501B Simplex Connectors

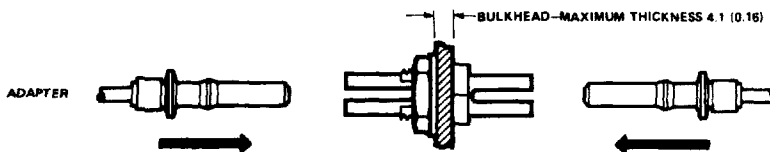

## Versatile Link Mechanical Dimensions

All dimensions in mm (inches).

All dimensions  $\pm 0.25$  mm unless otherwise specified.

### Fiber Optic Cable Dimensions

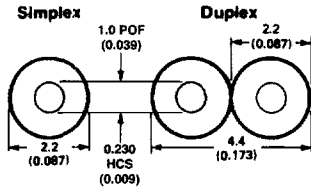

### Panel Mounting - Bulkhead Feedthrough

THREE TYPES OF PANEL/BULKHEAD HOLES CAN BE USED

DIMENSIONS IN mm (INCHES)  
 ALL DIMENSIONS  $\pm 0.2$  mm

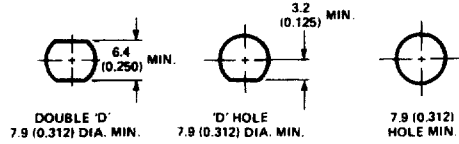

### HFBR-4505 (Gray)/4515 (Blue)/4505B (Black) Adapters

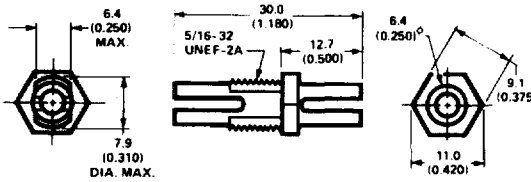

### Bulkhead Feedthrough with Two HFBR-4501/4511/4501B Connectors

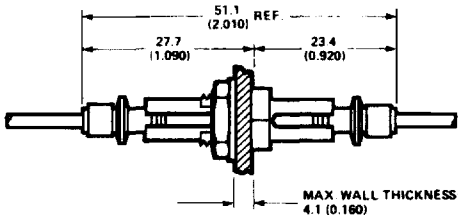

## Versatile Link Mechanical Dimensions, continued

**HFBR-4516 (Parchment)/4516B (Black) Duplex Latching Connector**

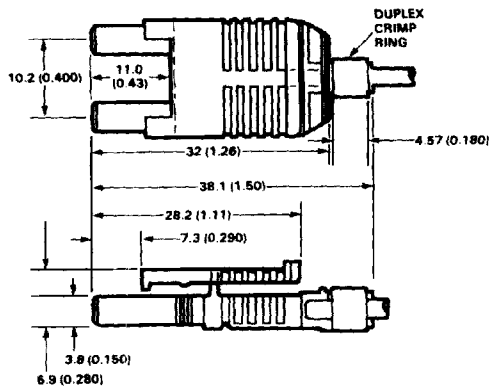

**HFBR-4506 (Parchment)/4506B (Black) Duplex Connector**

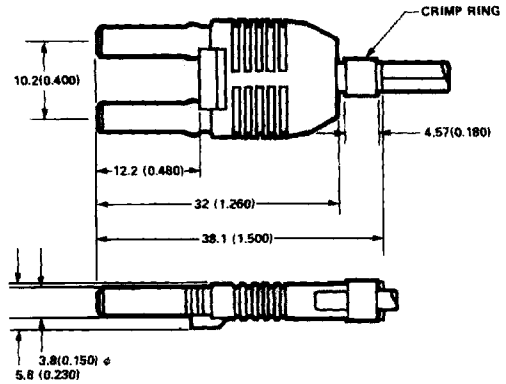

**HFBR-4503 (Gray)/4513 (Blue)/4503 (Black) Simplex Latching Connector**

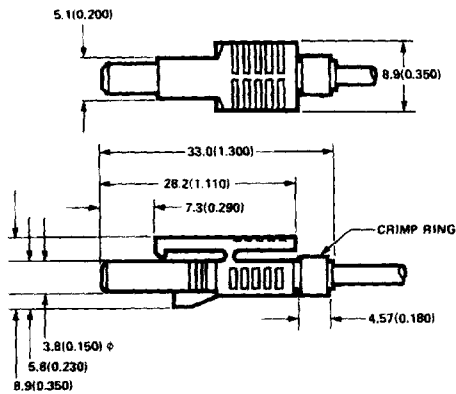

**HFBR-4501 (Gray)/4511 (Blue)/4501 (Black) Simplex Connector**

