

LOC	DIST	REVISIONS REVISIONI			
P	LTR REV	DESCRIPTION DESCRIZIONE	DATE DATA	DWN DIS.	APVD APP.
	B	(FIRST ISSUE) PRIMA EMISSIONE ET00-0364-99	18AUG98	G.S.	A.G.
	B1	RELEASED FOR PRODUCTION (ET00-0109-00)	24MAY00	M.S.	O.C.
	B2	ADDED P/N -5 AND -6 (ET00-0199-03)	06NOV2003	F.A.	O.C.
	B3	RELEASED FOR PROD. P/N -5/-6 ET00-0109-04	16JUN04	F.A.	O.C.

D  
C  
B  
A

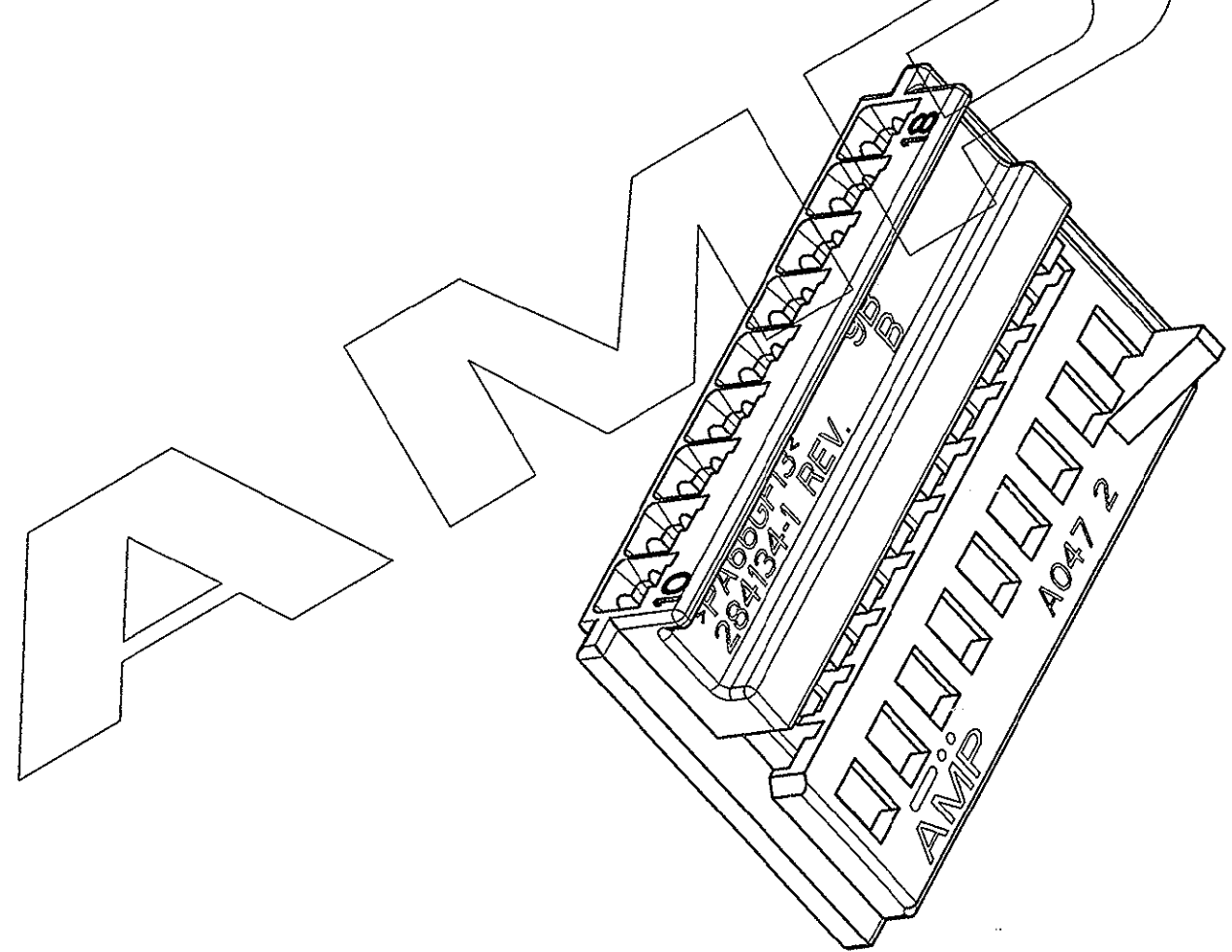
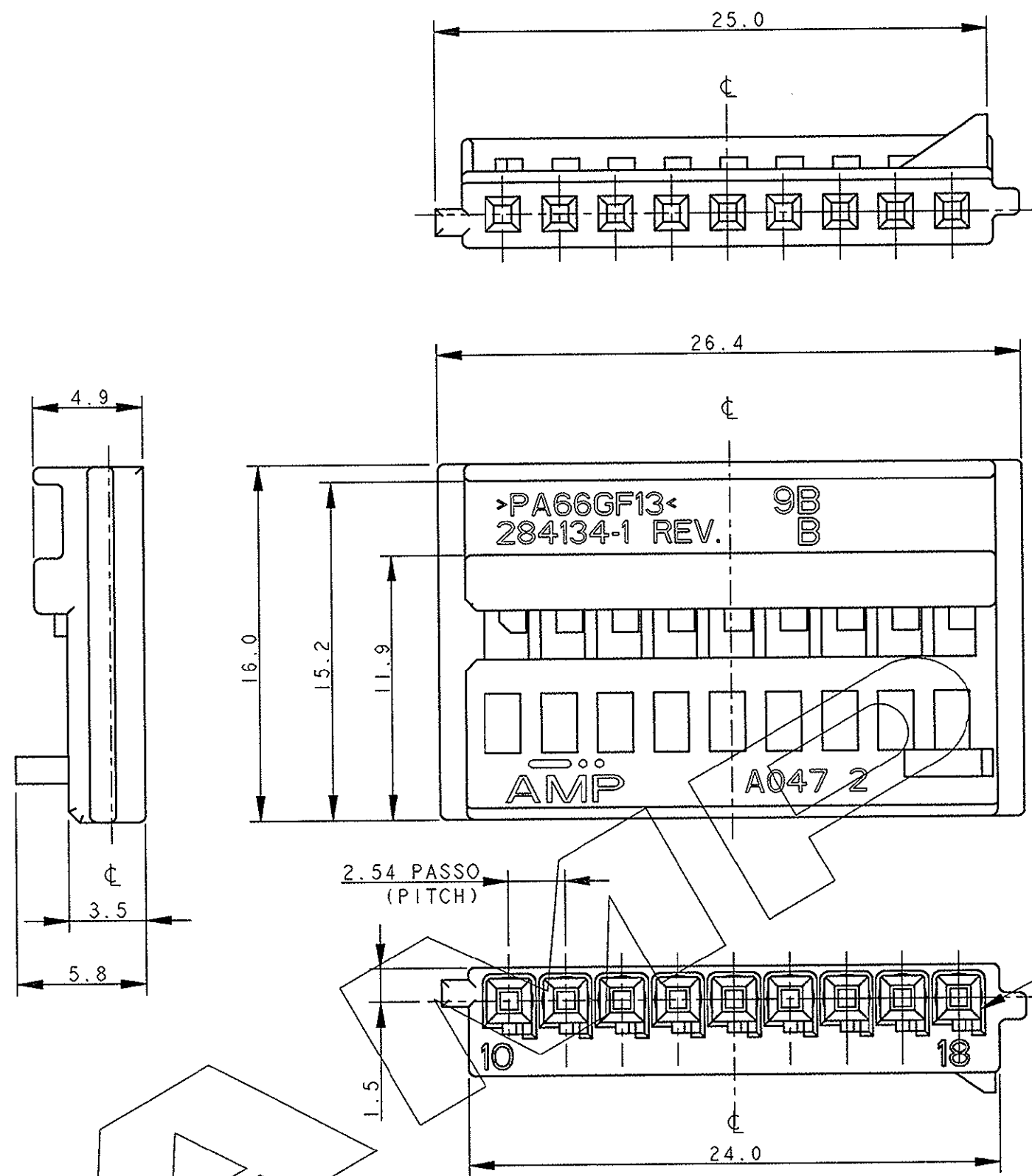

9 CAV. FOR MICRO QUADLOK CONTACT P/N 928999-1  
(9 CAV. PER CONTATTI MICRO QUADLOK P/N 928999-1)

NOTES: (NOTE:)

⚠ HOUSING MATERIAL: PA 6.6 G.F COLOUR BLACK  
(MATERIALE BLOCCHETTO: PA 6.6 CARICA VETRO COLORE NERO)

284134-1 COME MOSTRATO (AS SHOWN)

<small>THIS DRAWING IS A CONTROLLED DOCUMENT FOR TYCO ELECTRONICS CORPORATION. IT IS SUBJECT TO CHANGE AND THE CONTROLLING ENGINEERING ORGANIZATION SHOULD BE CONTACTED FOR THE LATEST REVISION.</small> <small>QUESTO DISEGNO È UN DOCUMENTO DI PROPRIETÀ E RESPONSABILITÀ DELL'AMP INCORPORATED. È SOGGETTO A VARIAZIONI. PER OTTENERE L'ULTIMA REVISIONE DEL DISEGNO CONTATTARE L'UFFICIO TECNICO RESPONSABILE.</small>		DWN/DIS. G. STELLA 16JUN97 CHK/CONT. A. GENTA 16JUN97 APVD/APP. A. BRUNI 16JUN97	<b>tyco</b> Electronics AMP Italia S.p.A. Collegno, C.so F.lli Cervi 15
DIMENSIONS: DIMENSIONI: mm 	TOLERANCES UNLESS OTHERWISE SPECIFIED: TOLLERANZE: SE NON DIVERSAMENTE SPECIFICATO 0 PLC/DEC ±0.3 1 PLC/DEC ±0.3 2 PLC/DEC ±0.3 3 PLC/DEC ± 4 PLC/DEC ± ANGLES/ANGOLI ±1°	NAME NONE PRODUCT SPEC SPEC DI PRODOTTO 108-20182 APPLICATION SPEC SPEC DI APPLICAZIONE	9 POS. PLUG HOUSING FOR MICRO QUADLOK CRIMP CONTACT
MATERIAL / MATERIALE 	FINISH FINITURA 	WEIGHT PESO - SIZE A3 CAGE CODE 00779 DRAWING NO. C-284134	RESTRICTED TO -
CUSTOMER DRAWING DISEGNO PER CLIENTE SOLO PER RIFERIMENTO		SCALE SCALA 4:1	SHEET FOGLIO 1 OF DI 5 REV B3

LOC	DIST	REVISIONS REVISIONI			
P	LTR REV	DESCRIPTION DESCRIZIONE	DATE DATA	DWN DIS.	APVD APP.
	-	VEDI FOGLIO 1 (SEE SHEET 1)	-	-	-

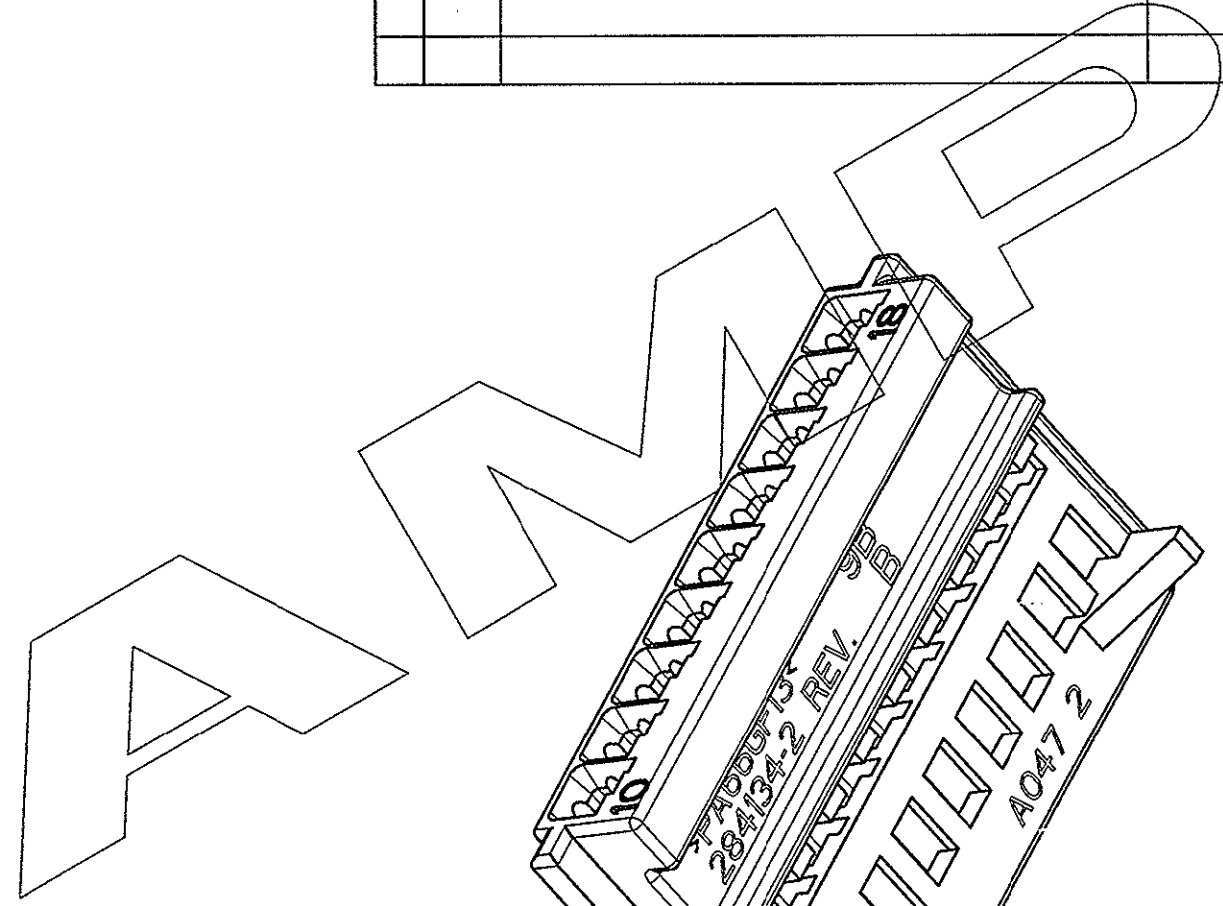
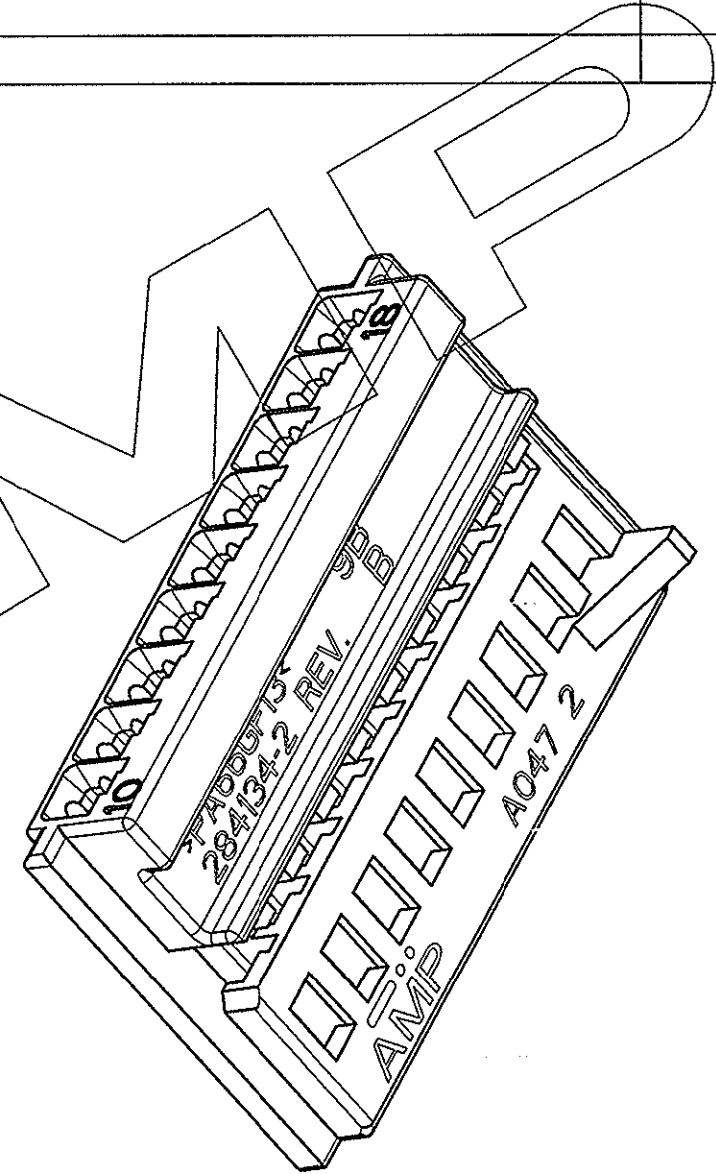
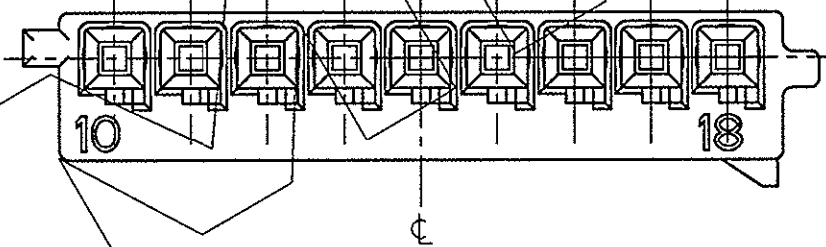
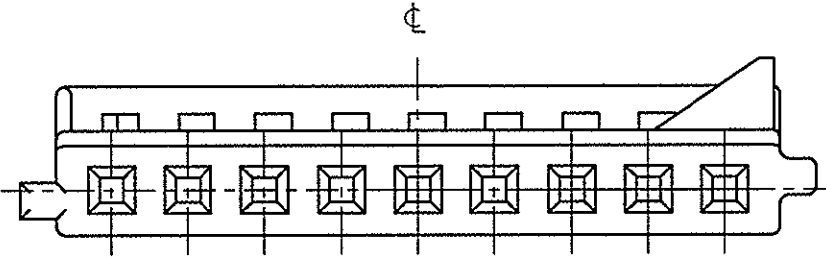
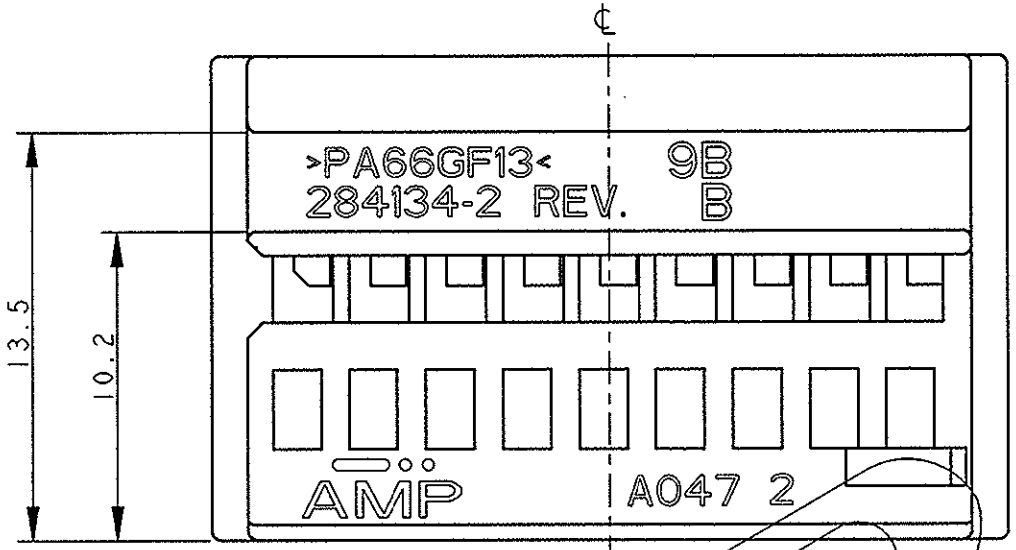
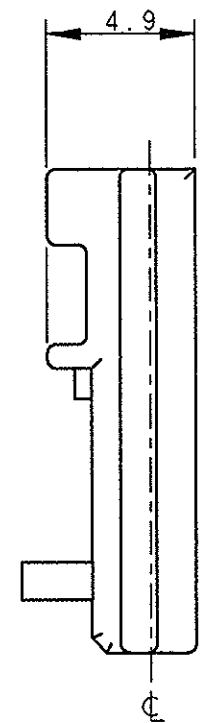

NOTES: (NOTE:)

- 1) HOUSING MATERIAL: PA 6.6 G.F COLOUR GRAY  
(MATERIALE BLOCCHETTO: PA 6.6 CARICA VETRO COLORE GRIGIO)
- 2) FOR MISSING DIMENSION AN NOTES SEE P/N 284134-1 SHEET 1  
(PER NOTE E DIMENSIONI MANCANTI VEDI P/N 284134-1 FOGLIO 1)

284134-2 COME MOSTRATO (AS SHOWN)

<small>THIS DRAWING IS A CONTROLLED DOCUMENT FOR TYCO ELECTRONICS CORPORATION                  IT IS SUBJECT TO CHANGE AND THE CONTROLLING ENGINEERING ORGANIZATION                  SHOULD BE CONTACTED FOR THE LATEST REVISION.                  QUESTO DISEGNO E' UN DOCUMENTO DI PROPRIETA' E RESPONSABILITA' DELL'                  AMP INCORPORATED. E' SOGGETTO A VARIAZIONI. PER OTTENERE L'ULTIMA                  REVISIONE DEL DISEGNO CONTATTARE L'UFFICIO TECNICO RESPONSABILE.</small>		DWN/DIS. 16JUN97 G. STELLA CHK/CONT. 16JUN97 A. GENTA APVD/APP. 16JUN97 A. BRUNI		<b>tyco</b> Electronics AMP Italia S.p.A. Collegno, C.so F.lli Cervi 15	
DIMENSIONS: DIMENSIONI: mm		TOLERANCES UNLESS OTHERWISE SPECIFIED: TOLLERANZE: SE NON DIVERSAMENTE SPECIFICATO		NAME NONE 9 POS. PLUG HOUSING FOR MICRO QUADLOK CRIMP CONTACT	
		0 PLC/DEC ±0.3 1 PLC/DEC ±0.3 2 PLC/DEC ±0.3 3 PLC/DEC ± 4 PLC/DEC ± ANGLES/ANGOLI ±1°		PRODUCT SPEC SPEC DI PRODOTTO 108-20182	
MATERIAL MATERIALE		FINISH FINITURA		APPLICATION SPEC SPEC DI APPLICAZIONE	
				SIZE CAGE CODE DRAWING NO A3 00779 C-284134	
WEIGHT PESO		CUSTOMER DRAWING DISEGNO PER CLIENTE SOLO PER RIFERIMENTO		RESTRICTED TO -	
		SCALE SCALA 4:1		SHEET FOGLIO 2 OF 5	
				REV B3	

LOC	DIST	REVISIONS			
P	LTR	DESCRIPTION	DATE	DWN	APVD
-	-	VEDI FOGLIO 1 (SEE SHEET 1)	-	-	-

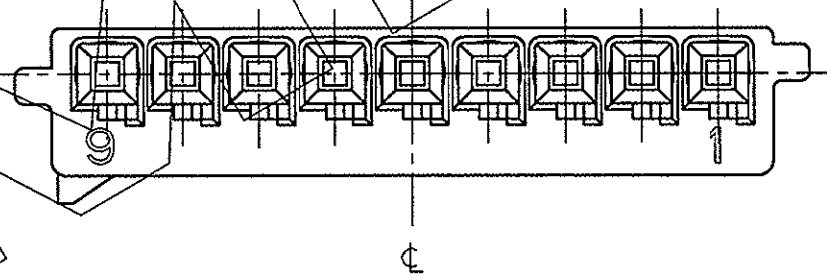
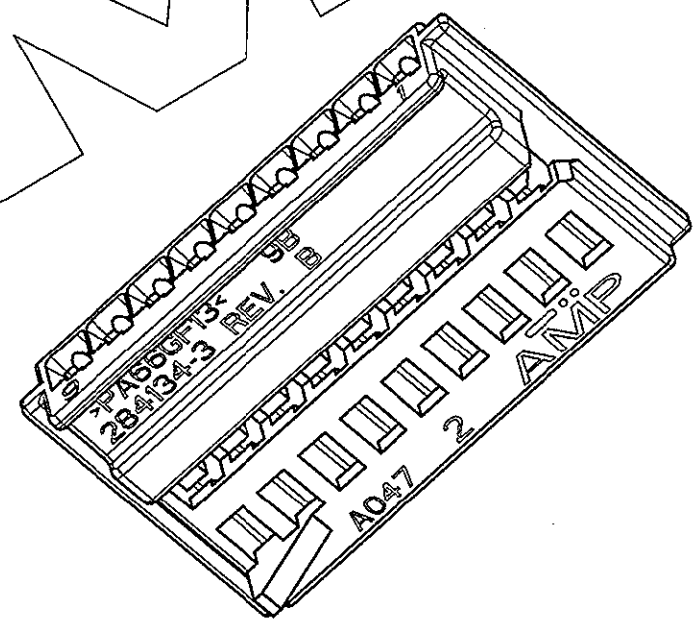
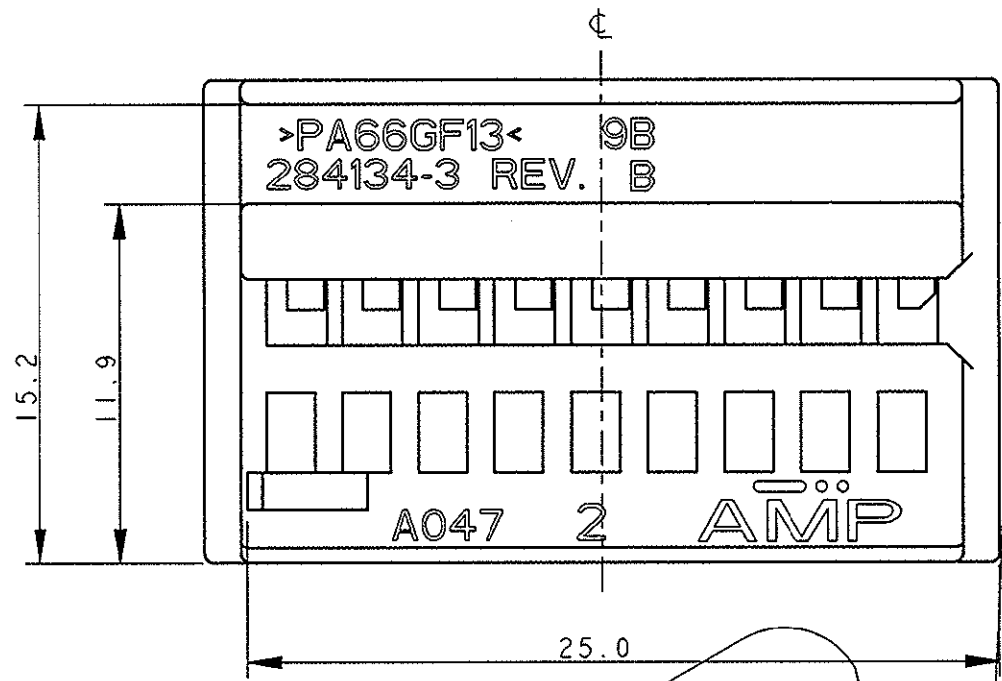
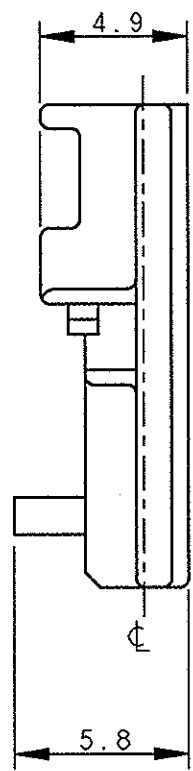

NOTES: (NOTE:)  
 1) HOUSING MATERIAL: PA 6.6 GLASS FILLED BLUE COLOUR  
 (MATERIALE BLOCCHETTO: PA 6.6 CARICATO VETRO COLORE BLUE)  
 2) FOR MISSING DIMENSIONS AN NOTES SEE P/N 284134-1 SHEET 1  
 (PER NOTE E DIMENSIONI MANCANTI VEDI P/N 284134-1 FOGLIO 1)

284134-3 COME MOSTRATO (AS SHOWN)

<small>THIS DRAWING IS A CONTROLLED DOCUMENT FOR TYCO ELECTRONICS CORPORATION                  IT IS SUBJECT TO CHANGE AND THE CONTROLLING ENGINEERING ORGANIZATION                  SHOULD BE CONTACTED FOR THE LATEST REVISION.</small>		DWN G. STELLA 16 JUN 97	<b>tyco</b> AMP Italia S.p.A. Collegno, C.so F.lli Cervi 15	
DIMENSIONS: mm		CHK A. GENTA 16 JUN 97	NAME 9 POS. PLUG HOUSING FOR MICRO QUADLOK CRIMP CONTACT	
TOLERANCES UNLESS OTHERWISE SPECIFIED: 0 PLC ± 0.3 1 PLC ± 0.3 2 PLC ± 0.3 3 PLC ± - 4 PLC ± - ANGLES ± 1°		APVD A. BRUNI 16 JUN 97	PRODUCT SPEC 108-20182	
MATERIAL 		PRODUCT SPEC -	APPLICATION SPEC -	RESTRICTED TO -
FINISH 		WEIGHT -	SIZE A3	CAGE CODE 00779
CUSTOMER DRAWING			DRAWING NO C-284134	SCALE 4:1
			SHEET 3	OF 5
			REV B3	

P	LTR	DESCRIPTION	DATE	DWN	APVD
-	-	VEDI FOGLIO 1 (SEE SHEET 1)	-	-	-

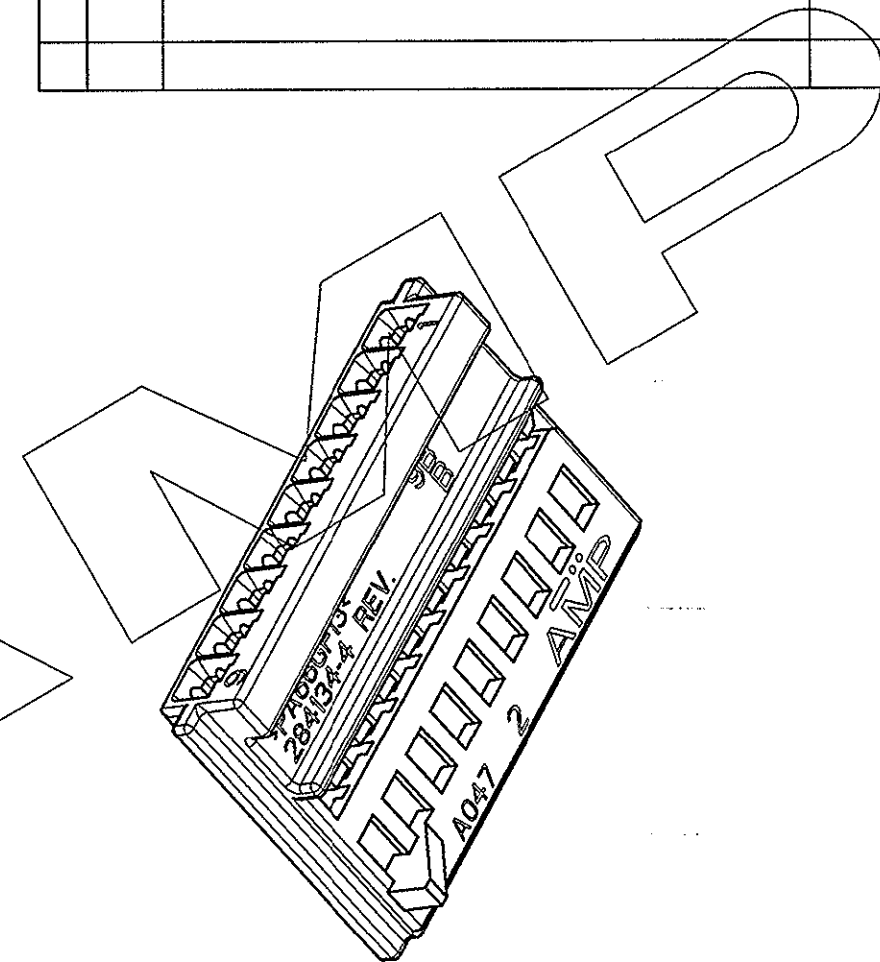
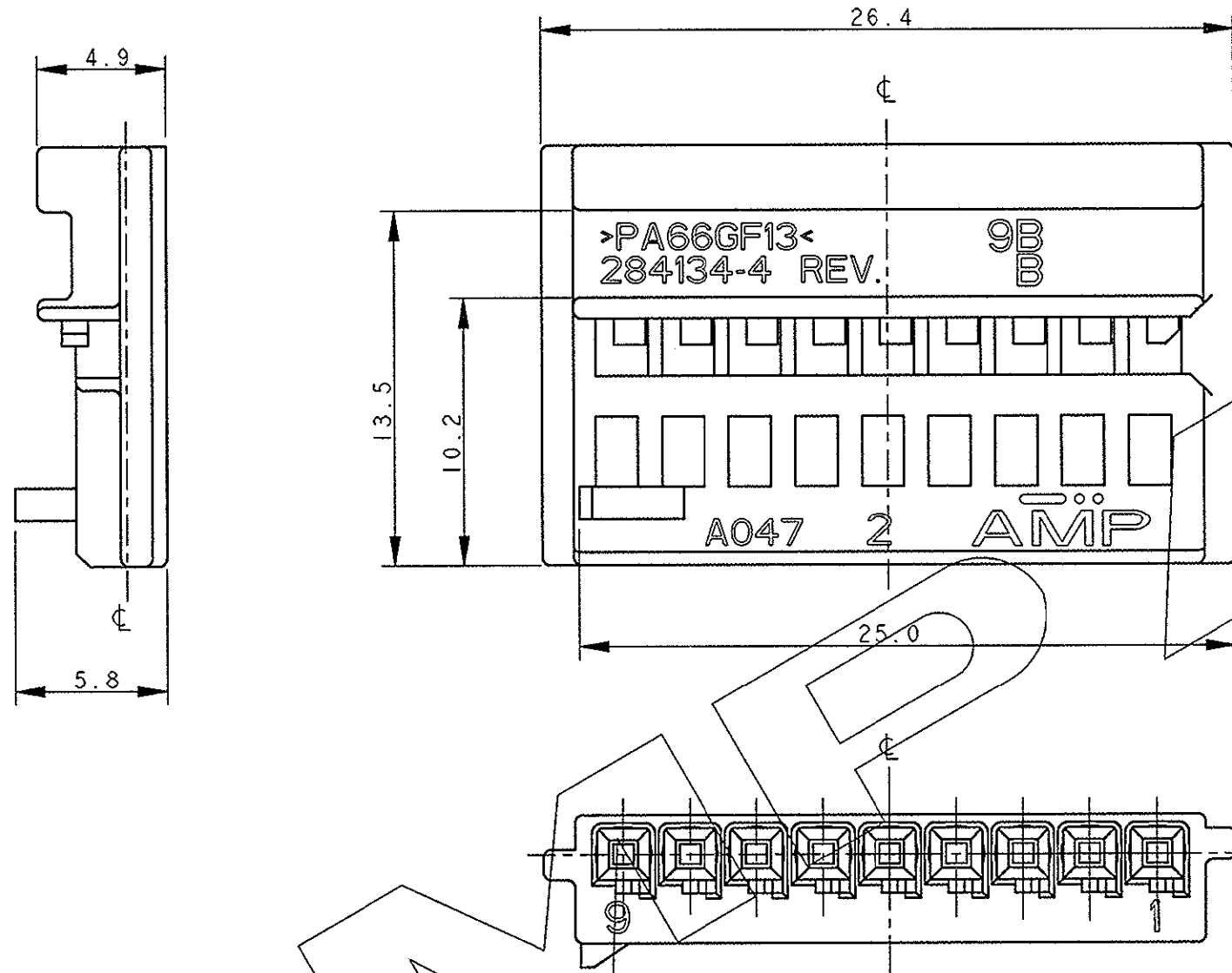

NOTES: (NOTE)

1) HOUSING MATERIAL: PA 6.6 GLASS FILLED BROWN COLOUR (MATERIALE BLOCCHETTO: PA 6.6 CARICATO VETRO COLORE MARRONE)

2) FOR MISSING DIMENSIONS AN NOTES SEE P/N 284134-1 SHEET 1 (PER NOTE E DIMENSIONI MANCANTI VEDI P/N 284134-1 FOGLIO 1)

284134-4 COME MOSTRATO (AS SHOWN)

<small>THIS DRAWING IS A CONTROLLED DOCUMENT FOR TYCO ELECTRONICS CORPORATION IT IS SUBJECT TO CHANGE AND THE CONTROLLING ENGINEERING ORGANIZATION SHOULD BE CONTACTED FOR THE LATEST REVISION.</small>		DWN G. STELLA 16JUN97			AMP Italia S.p.A. Collegno, C.so F.lli Cervi 15
DIMENSIONS: mm		CHK A. GENTA 16JUN97	NAME 9 POS. PLUG HOUSING FOR MICRO QUADLOK CRIMP CONTACT		
		APVD A. BRUNI 16JUN97	PRODUCT SPEC 108-20182		
TOLERANCES UNLESS OTHERWISE SPECIFIED: 0 PLC ± 0.3 1 PLC ± 0.3 2 PLC ± 0.3 3 PLC ± - 4 PLC ± - ANGLES ± 1°		APPLICATION SPEC -	SIZE A3	CAGE CODE 00779	DRAWING NO C-284134
MATERIAL 		WEIGHT -	RESTRICTED TO -		
FINISH 		CUSTOMER DRAWING		SCALE 4:1	SHEET 4 OF 5
				REV B3	

LOC	DIST	REVISIONS			
P	LTR	DESCRIPTION	DATE	DWN	APVD
A1	-	-	-	-	-
		VEDI FOGLIO 1 (SEE SHEET 1)			

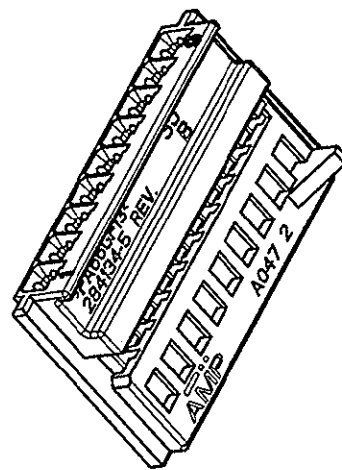
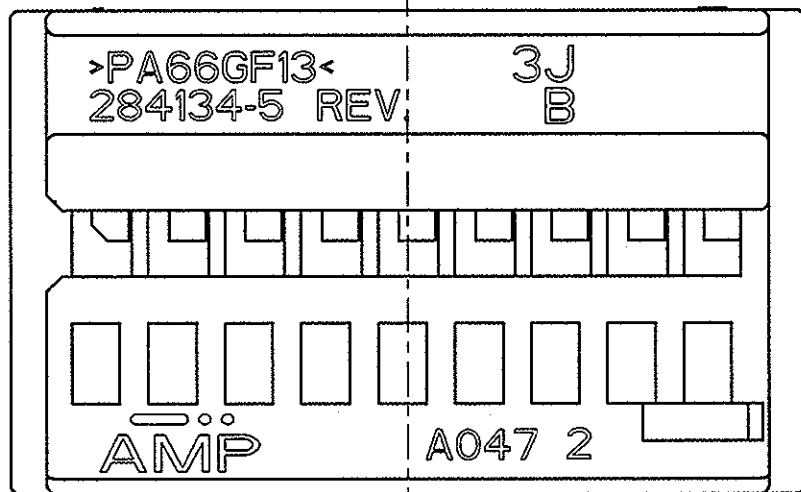

SCALE 2:1

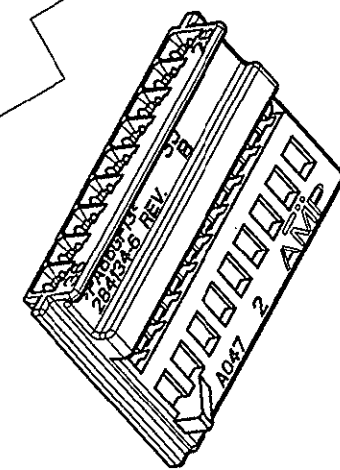
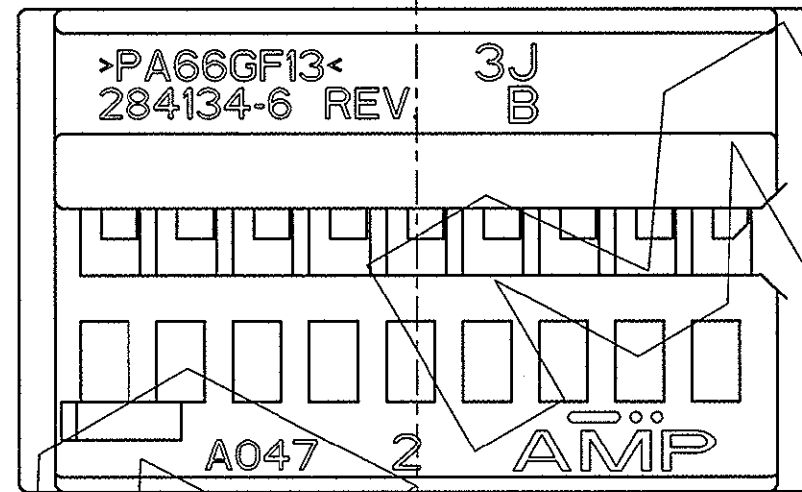
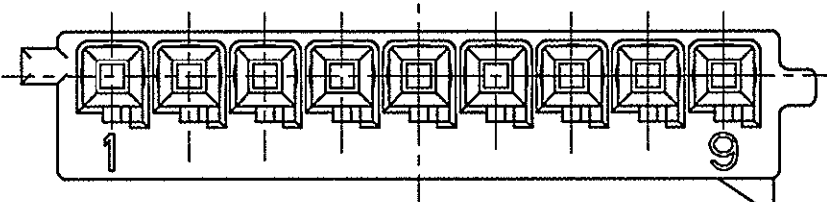

SCALE 2:1

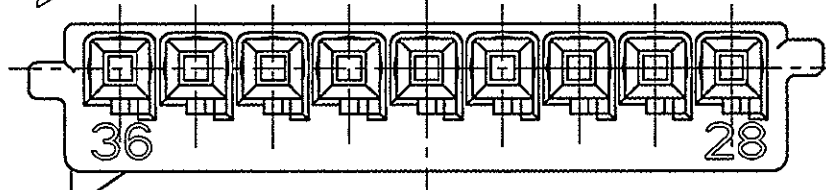

284134-6 COME MOSTRATO (AS SHOWN)

NOTES: (NOTE)

- 1) HOUSING MATERIAL: PA 6.6 G.F COLOUR GREEN (MATERIALE BLOCCHETTO: PA 6.6 CARICA VETRO COLORE VERDE)
- 2) FOR MISSING DIMENSIONS AN NOTES SEE P/N 284134-1 SHEET 1 (PER NOTE E DIMENSIONI MANCANTI VEDI P/N 284134-1 FOGLIO 1)

284134-5 COME MOSTRATO (AS SHOWN)

NOTES: (NOTE)

- 1) HOUSING MATERIAL: PA 6.6 G.F COLOUR WHITE (MATERIALE BLOCCHETTO: PA 6.6 CARICA VETRO COLORE BIANCO)
- 2) FOR MISSING DIMENSIONS AN NOTES SEE P/N 284134-3 SHEET 3 (PER NOTE E DIMENSIONI MANCANTI VEDI P/N 284134-3 FOGLIO 3)

<small>THIS DRAWING IS A CONTROLLED DOCUMENT FOR TYCO ELECTRONICS CORPORATION IT IS SUBJECT TO CHANGE AND THE CONTROLLING ENGINEERING ORGANIZATION SHOULD BE CONTACTED FOR THE LATEST REVISION.</small>		DWN G. STELLA 16JUN97	<b>tyco</b> AMP Italia S.p.A. Collegno, C.so F.lli Cervi 15	
DIMENSIONS: mm		CHK A. GENTA 16JUN97	NAME 9 POS. PLUG HOUSING FOR MICRO QUADLOK CRIMP CONTACT	
TOLERANCES UNLESS OTHERWISE SPECIFIED: 0 PLC ±0.3 1 PLC ±0.3 2 PLC ±0.3 3 PLC ± 4 PLC ± ANGLES ±1°		APVD A. BRUNI 16JUN97	DRAWING NO A3 00779 C=284134	
MATERIAL -		PRODUCT SPEC 108-20182	RESTRICTED TO -	
FINISH -		APPLICATION SPEC -	SCALE 5:1 SHEET 5 OF 5 REV B3	
WEIGHT -		CUSTOMER DRAWING		

# Mouser Electronics

Authorized Distributor

Click to View Pricing, Inventory, Delivery & Lifecycle Information:

[TE Connectivity:](#)

[284134-1](#)