

Power cable - SAC-5P-10,0-PUR/M12FRK PE - 1414817

Please be informed that the data shown in this PDF Document is generated from our Online Catalog. Please find the complete data in the user's documentation. Our General Terms of Use for Downloads are valid (<http://phoenixcontact.com/download>)



Power cable, 5-position, PUR halogen-free, black-gray RAL 7021, Socket angled M12, K-coded, on free cable end, cable length: 10 m, for AC current up to 16 A/690 V

Your advantages

- ✓ Easy and safe: 100% electrically tested plug-in components
- ✓ High-performance: AC connectors for up to 16 A and 690 V AC
- ✓ Protection against mismatching, thanks to special K-coding
- ✓ Our standard: robust halogen-free PUR cable



Key Commercial Data

Packing unit	1 pc
GTIN	 4 055626 034508
GTIN	4055626034508

Technical data

Dimensions

Length of cable	10 m
-----------------	------

Ambient conditions

Ambient temperature (operation)	-25 °C ... 85 °C (Plug / socket)
Degree of protection	IP65
	IP67

General

Rated current at 40°C	16 A
Rated voltage	690 V AC
Number of positions	5
Color handle area	black
Insulation resistance	≥ 100 MΩ

Power cable - SAC-5P-10,0-PUR/M12FRK PE - 1414817

Technical data

General

Coding	K - Power
Standards/regulations	M12 connector IEC 61076-2-111
Status display	No
Protective circuit/component	unwired
Overvoltage category	III
Degree of pollution	3
Insertion/withdrawal cycles	≥ 100
Torque	0.4 Nm (M12 connector)

Material

Flammability rating according to UL 94	V0
Contact material	CuSn
Contact surface material	Ni/Au
Contact carrier material	PA
Material of grip body	PA
Material, knurls	Zinc die-cast, nickel-plated

Standards and Regulations

Standard designation	M12 connector
Standards/regulations	IEC 61076-2-111
Flammability rating according to UL 94	V0

Cable

Cable type	PUR halogen-free black
Cable type (abbreviation)	PUR
UL AWM style	22078 / 11560 (90 °C / 1000 V)
Conductor cross section	5x 2.5 mm ²
AWG power supply	14
Conductor structure, voltage supply	141x 0.15 mm
Core diameter including insulation	2.8 mm ±0.1 mm
Thickness, insulation	≥ 0.36 mm
Wire colors	Black 1, black 2, black 3, black 4, green/yellow
External sheath, color	black-gray RAL 7021
Outer sheath thickness	approx. 1.15 mm
External cable diameter D	9.7 mm ±0,3 mm
Minimum bending radius, fixed installation	5 x D
Minimum bending radius, flexible installation	10 x D
Number of bending cycles	4000000
Minimum bending radius, drag chain applications	10 x D
Traversing path	10 m
Traversing rate	3 m/s
Acceleration	10 m/s ²

Power cable - SAC-5P-10,0-PUR/M12FRK PE - 1414817

Technical data

Cable

Cable weight	189 kg/km
Outer sheath, material	PUR
Material conductor insulation	PP
Conductor material	Bare Cu litz wires
Insulation resistance	≥ 1 GΩ*km (at 20 °C)
Conductor resistance	≤ 8 Ω/km (at 20 °C)
Nominal voltage, cable	≤ 1000 V AC
Test voltage, cable	≥ 10000 V AC (Spark test)
Flame resistance	According to UL 758/1581 (Cable Flame)
	according to UL 758/1581 FT1
	According to DIN EN 60332-1-2
Halogen-free	in accordance with DIN VDE 0472 part 815
	in accordance with DIN EN 50267-2-1
Resistance to oil	according to DIN EN 60811-404, 168 h at 100 °C
Other resistance	Hydrolysis and microbe resistant as per VDE 0282 section 10
	Low adhesion
	abrasion-resistant
	Resistant to salt water
Ambient temperature (operation)	-50 °C ... 90 °C (cable, fixed installation)
	-30 °C ... 90 °C (cable, flexible installation)

Environmental Product Compliance

China RoHS	Environmentally Friendly Use Period = 50
	For details about hazardous substances go to tab "Downloads", Category "Manufacturer's declaration"

Drawings

Schematic diagram

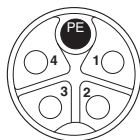

Pin assignment of M12 socket, 5-pos., K-coded, socket side view

Cable cross section

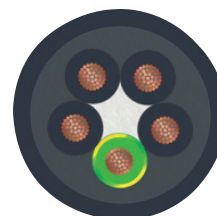

PUR halogen-free black [PUR]

Power cable - SAC-5P-10,0-PUR/M12FRK PE - 1414817

Diagram

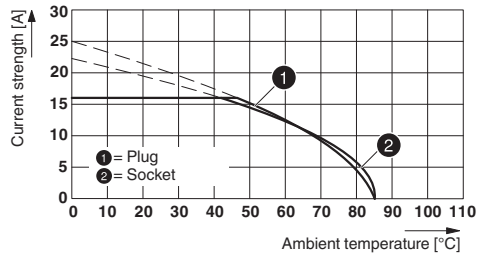

Dimensional drawing

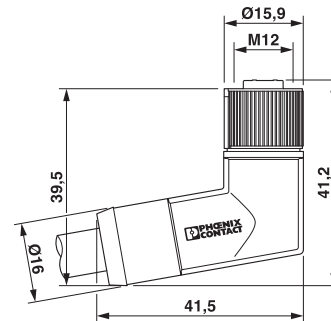

M12 x 1 socket, angled

Circuit diagram



Contact assignment of the M12 socket

Approvals

Approvals

Approvals

UL Listed / cUL Listed / EAC / cULus Listed

Ex Approvals

Approval details

UL Listed		http://database.ul.com/cgi-bin/XYV/template/LISEXT/1FRAME/index.htm	E468743
Nominal voltage UN	600 V		
Nominal current IN	16 A		
mm ² /AWG/kcmil	14		

Power cable - SAC-5P-10,0-PUR/M12FRK PE - 1414817

Approvals

cUL Listed		http://database.ul.com/cgi-bin/XYV/template/LISEXT/1FRAME/index.htm	E468743
------------	---	---	---------

Nominal voltage UN	600 V
Nominal current IN	16 A
mm ² /AWG/kcmil	14

EAC		RU C- DE.AI30.B.00767
-----	---	--------------------------

cULus Listed	
--------------	---

Phoenix Contact 2019 © - all rights reserved
<http://www.phoenixcontact.com>

PHOENIX CONTACT GmbH & Co. KG
Flachsmarktstr. 8
32825 Blomberg
Germany
Tel. +49 5235 300
Fax +49 5235 3 41200
<http://www.phoenixcontact.com>