

TOSHIBA LED DISPLAY

TLRA336S, TLRA337S

ULTRA BRIGHT AND LOW CURRENT DRIVE RED COLOR 1DIGIT COMPACT PACKAGE NUMERICAL DISPLAY

- 8.0mm (0.3") Character Height.
- Gray Color Coated Only on Surface.
- Available Both Polarity of Connections, Common Cathode or Common Anode.
- High Efficiency at Low Current.
- Luminous Intensity Ranking Performed Uniform Display, @2mA / segment.

PRODUCT LINE UP

TLRA336S/TLRA337S	GaAlAs RED
-------------------	------------

TYPE No. vs FULLY DISPLAY FONT

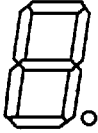
COMMON CATHODE	COMMON ANODE	FULLY DISPLAY FONT
TLRA336S	TLRA337S	

MAXIMUM RATINGS (Ta = 25°C)

CHARACTERISTIC	SYMBOL	RATING	UNIT
DC Forward Current / seg.	I_F (DC) / seg	20	mA
Pulse Forward Current / seg. (Note)	I_{FP} / seg	110	mA
DC Reverse Voltage / seg.	V_R	6	V
Operating Temperature Range	T_{opr}	-40~85	°C
Storage Temperature Range	T_{stg}	-40~85	°C

Note : Pulse Width = 1ms, Duty Ratio = 1 / 10

ELECTRICAL-OPTICAL CHARACTERISTICS (Ta = 25°C)

TYPE No.	EMITTING WAVE LENGTH			LUMINOUS INTENSITY I_V / seg			FORWARD VOLTAGE V_F / seg				REVERSE CURRENT I_R / seg		LUMINOUS INTENSITY MATCHING RATIO I_V -M	
	λ_p	$\Delta\lambda$	I_F /seg	Min.	Typ.	I_F /seg	Min.	Typ.	Max.	I_F /seg	Max.	V_R /seg	Max.	I_F /seg
TLRA Series	660	25	2	0.80	2.80	2	1.3	1.6	2.05	2	100	6	2.3	2
UNIT	nm		mA	mcd		mA	V			mA	μ A	V	—	mA

PRECAUTION

Please be careful of the following.

- Soldering temperature should be less than 260°C for 3 seconds at 2.0mm from the seating plane.

961001EAC2

● TOSHIBA is continually working to improve the quality and the reliability of its products. Nevertheless, semiconductor devices in general can malfunction or fail due to their inherent electrical sensitivity and vulnerability to physical stress. It is the responsibility of the buyer, when utilizing TOSHIBA products, to observe standards of safety, and to avoid situations in which a malfunction or failure of a TOSHIBA product could cause loss of human life, bodily injury or damage to property. In developing your designs, please ensure that TOSHIBA products are used within specified operating ranges as set forth in the most recent products specifications. Also, please keep in mind the precautions and conditions set forth in the TOSHIBA Semiconductor Reliability Handbook.

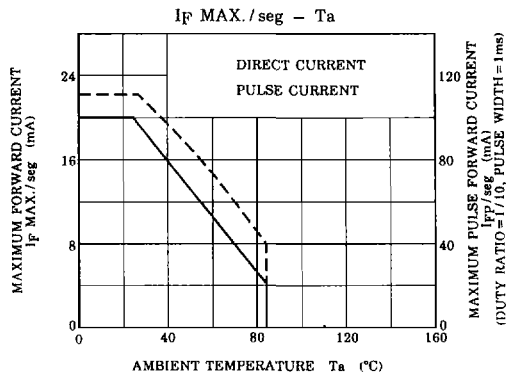
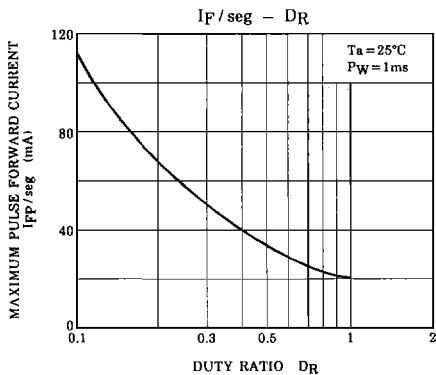
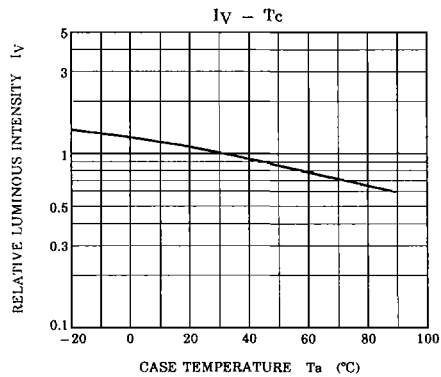
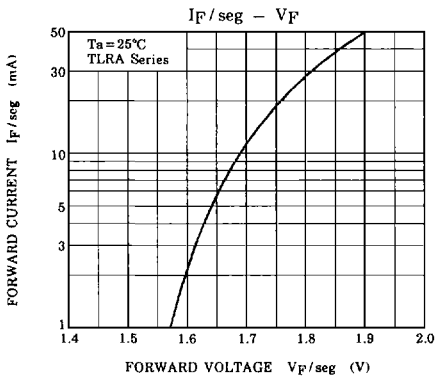
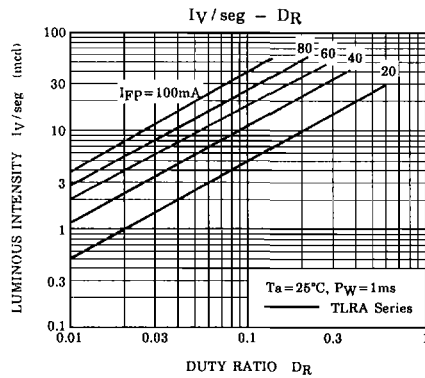
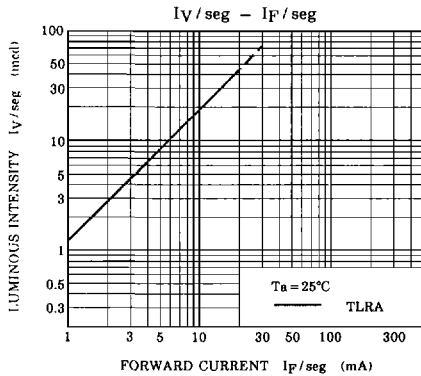

961001EAC2'

- Gallium arsenide (GaAs) is a substance used in the products described in this document. GaAs dust and fumes are toxic. Do not break, cut or pulverize the product, or use chemicals to dissolve them. When disposing of the products, follow the appropriate regulations. Do not dispose of the products with other industrial waste or with domestic garbage.
- The information contained herein is presented only as a guide for the applications of our products. No responsibility is assumed by TOSHIBA CORPORATION for any infringements of intellectual property or other rights of the third parties which may result from its use. No license is granted by implication or otherwise under any intellectual property or other rights of TOSHIBA CORPORATION or others.
- The information contained herein is subject to change without notice.

OUTLINE DIMENSIONS

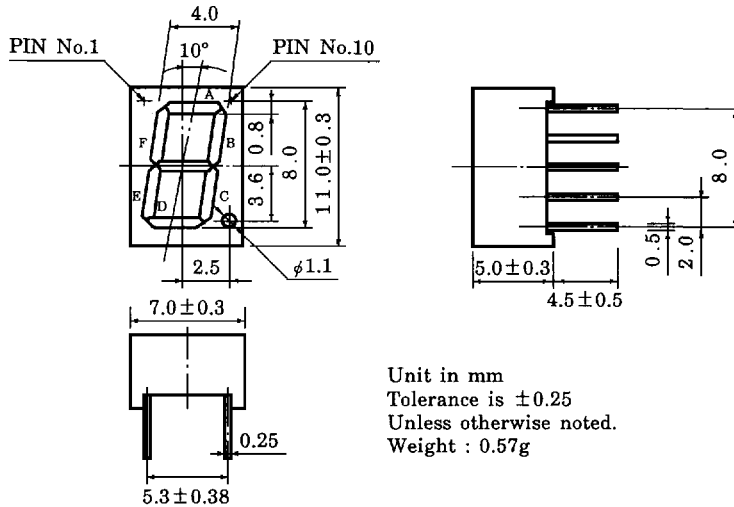

PIN CONNECTION

336S Series		337S Series	
PIN No.	CONNECTION	PIN No.	CONNECTION
1	Anode A	1	Cathode A
2	Anode F	2	Cathode F
3	Anode G	3	Cathode G
4	Anode E	4	Cathode E
5	Anode D	5	Cathode D
6	Cathode Dp (Right Hand)	6	Cathode Dp (Right Hand)
7	Anode Dp (Right Hand)	7	Anode Dp (Right Hand)
8	Anode C	8	Cathode C
9	Common Cathode	9	Common Anode
10	Anode B	10	Cathode B