

- ◆ CMOS
- ◆ Mini Mold Package
- ◆ Highly Accurate: $\pm 2\%$ ($\pm 1\%$)
- ◆ Low Power Consumption $1.0\mu\text{A Typ.}$ ($V_{\text{IN}}=2\text{V}$)

Applications

- Microprocessor reset circuits
- Memory battery back-up circuits
- Power-on reset circuits
- Power failure detection
- System battery life and charge voltage monitors

General Description

The XC61A is a highly precise detector series manufactured using CMOS and laser trimming technologies.

The series is very accurate and offers standard voltage sourced low power consumption. The series consists of hysteresis, output driver, and linear characterised delay circuits, together with a comparator. Detect voltage is extremely accurate with minimal temperature drift. Both CMOS and N-channel open drain output configurations are available.

Integrating the above functions in a single, mini-molded package, the XC61A series offers significant space saving and high-density mounting, suitable for use with portable products.

Features

Highly accurate: Detect voltage $\pm 2\%$ ($\pm 1\%$ for semi-custom products)

Low power consumption: Typ. $1.0\mu\text{A}$ ($V_{\text{IN}}=2\text{V}$)

Selectable detect voltage: Range 2.1V ~ 6.0V in 0.1V increments.

Operating voltage: From 0.7V ~ 10.0V.

Temperature Characteristics: Typ. $\pm 100\text{ppm}/^\circ\text{C}$

Output configuration: N-channel open drain or CMOS

Ultra small package: SOT-23 (150mW) mini-mold SOT-89 (500mW) mini-power mold

*TO-92 (300mW) packages also available. (order basis)

Pin Configuration

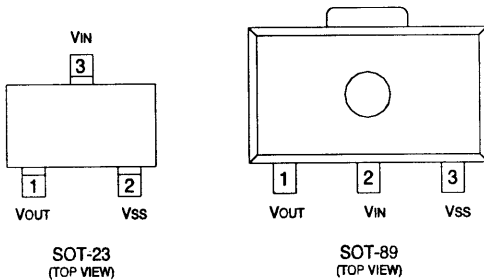

Pin Assignment

PIN NUMBER		PIN NAME	FUNCTION
SOT-23	SOT-89		
3	2	V_{IN}	Supply voltage input
2	3	V_{SS}	Ground
1	1	V_{OUT}	Output

Block Diagram

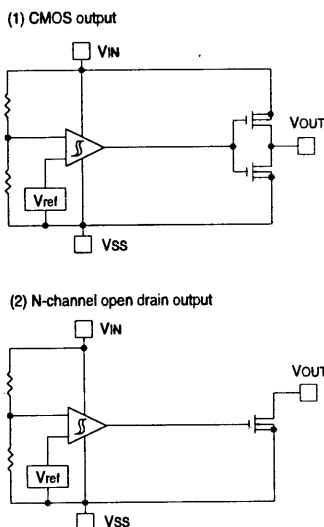

Absolute Maximum Ratings

$T_a=25^\circ\text{C}$

PARAMETER	SYMBOL	RATINGS	UNITS
Input Voltage	V_{IN}	12	V
Output Voltage	V_{OUT}	$V_{\text{SS}}-0.3 \sim V_{\text{IN}}+0.3$	V
Output Current	I_{OUT}	50	mA
Continuous Total Power Dissipation	SOT-23	150	mW
	SOT-89	500	
Operating Ambient Temperature	T_{opr}	$-30 \sim +80$	$^\circ\text{C}$
Storage Temperature	T_{stg}	$-40 \sim +125$	$^\circ\text{C}$

Electrical Characteristics

Ta=25°C

PARAMETER	SYMBOL	CONDITIONS	MIN	TYP	MAX	UNITS
Detect Voltage	V _{DF}		V _{DF} ×0.98	V _{DF}	V _{DF} ×1.02	V
Hysteresis Range	V _{HYS}		×0.02	×0.05	×0.08	V
Supply Current	I _{SS}	V _{IN} =1.5V =2.0V =3.0V =4.0V =5.0V		0.9 1.0 1.3 1.6 2.0	2.6 3.0 3.4 3.8 4.2	μA
Operating Voltage	V _{IN}	V _{DF} =2.1~6.0V	0.7		10.0	V
Output Current	I _{OUT}	N-ch V _{DS} =0.5V V _{IN} =1.0V =2.0V =3.0V =4.0V =5.0V		2.2 7.7 10.1 11.5 13.0		mA
		N-ch V _{DS} =2.1V V _{IN} =8.0V (CMOS Output)		-10.0		
Temperature Characteristics	ΔV _{DF} /(ΔT _{opr} V _{DF})	-30°C ≤ T _{opr} ≤ 80°C		±100		ppm/°C
Delay Time(Release Voltage →Output Inversion)	t _{DLY} (V _{DR} →V _{OUT} Inversion)				0.2	ms

- Note: 1. The products that have 1% Detect Voltage (V_{DF}) accuracy are semi-custom products.
 2. An additional resistor connected between the Vin pin and the supply voltage may cause alterations in the characteristics due to the increasing values of V_{DR}.

Notes on Use

Where a resistor (R_{IN}) is connected between V_{IN} and the power supply, use the N-ch open drain configuration. In order to prevent oscillation please ensure that R_{IN} = 1kΩ or less and that C = 0.1μF or more.

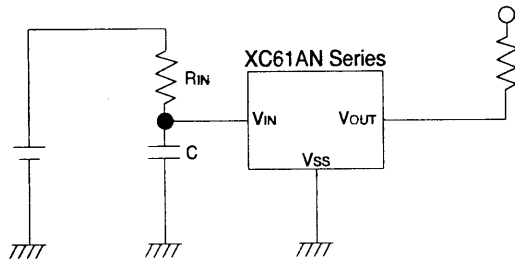

Diagram : Circuit with input resistor connected.

Functional Description

The following designators ①-⑥ refer to the timing diagram below:

- ① When the Input Voltage (V_{IN}) is higher than the Detect Voltage (V_{DF}) level, output at the V_{OUT} pin is equal to V_{IN}. (High impedance exists with the N-channel open drain output configuration).
- ② When the Input Voltage (V_{IN}) falls below the Detect Voltage (V_{DF}) level, the Output Voltage (V_{OUT}) is equal to the Ground Voltage (V_{SS}) level.
- ③ When the Input Voltage (V_{IN}) falls below the Minimum Operating Voltage (V_{MIN}) level, output becomes unstable. In this condition, if there is an output pull-up, V_{IN} will be the output.
- ④ When the Input Voltage (V_{IN}) rises above the ground voltage (V_{SS}) level, output becomes unstable between the Ground Voltage (V_{SS}) level and the Minimum Operating Voltage (V_{MIN}) level. Between the V_{MIN} and V_{DR} levels the Ground Voltage (V_{SS}) level is maintained.
- ⑤ When the Input Voltage (V_{IN}) rises above the Detect Release Voltage (V_{DR}) level, output at the V_{OUT} pin is equal to V_{IN}. (High impedance exists with the N-channel open drain output configuration).
- ⑥ The difference between V_{DR} and V_{DF} represents the hysteresis range.

Timing Diagram

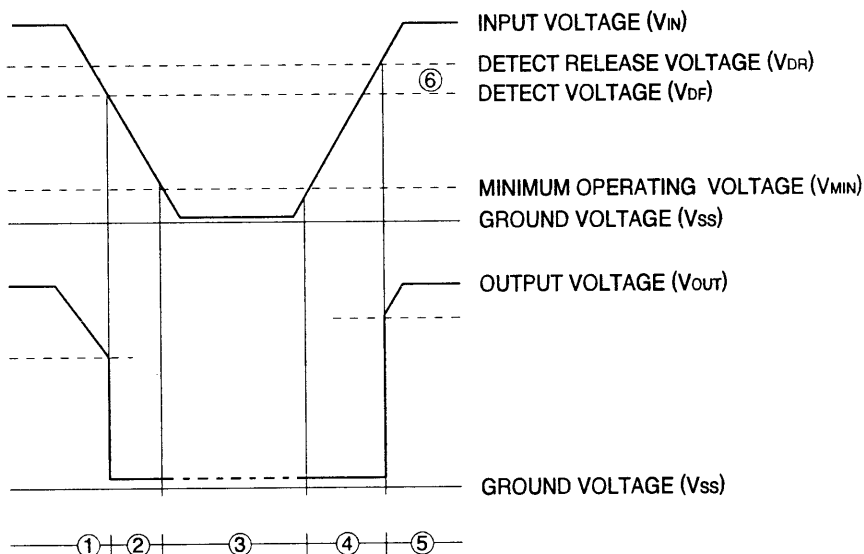

Ordering Information

XC61Axxxxxxx

↑↑↑↑↑
a b c d e f

DESIGNATOR	DESCRIPTION	DESIGNATOR	DESCRIPTION
a	<u>Output Configuration</u> C=CMOS Output N=N-Channel Open Drain	d	<u>Detect Accuracy</u> 1=±1% (Semi -custom products) 2=±2%
b	<u>Detect Voltage</u> e.g.25=2.5V 38=3.8V	e	<u>Package Type</u> M=SOT-23 P=SOT-89 T=TO-92
c	<u>Output Delay</u> Standard products have no delay. 0=No Delay (Standard product) Custom products which have customer specified delay time are available.	f	<u>Device Orientation</u> R=Embossed Tape (Orientation of Device:Right) L=Embossed Tape (Orientation of Device:Left) H=Paper Tape (TO-92) B=Bag (TO-92)

Marking

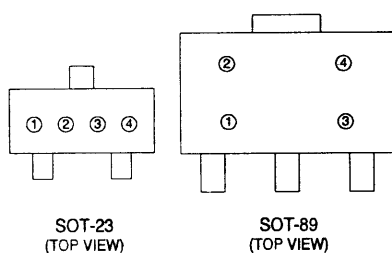

① Configuration and Integral Number of Detect Voltage

DESIGNATOR	CONFIGURATION	VOLTAGE(V)	DESIGNATOR	CONFIGURATION	VOLTAGE(V)
A	CMOS	0.②	K	N-channel	0.②
B	CMOS	1.②	L	N-channel	1.②
C	CMOS	2.②	M	N-channel	2.②
D	CMOS	3.②	N	N-channel	3.②
E	CMOS	4.②	P	N-channel	4.②
F	CMOS	5.②	R	N-channel	5.②
H	CMOS	6.②	S	N-channel	6.②

② Decimal Point of Detect Voltage

DESIGNATOR	VOLTAGE(V)	DESIGNATOR	VOLTAGE(V)
0	①.0	5	①.5
1	①.1	6	①.6
2	①.2	7	①.7
3	①.3	8	①.8
4	①.4	9	①.9

③ Output delay time

DESIGNATOR	DELAY TIME (ms)
0	No Delay

Note: Symbol '0' is Standard spec.

④ Assembly Lot Number

Based on internal standards.

XC61AC Characteristics

(1) SUPPLY CURRENT vs. INPUT VOLTAGE

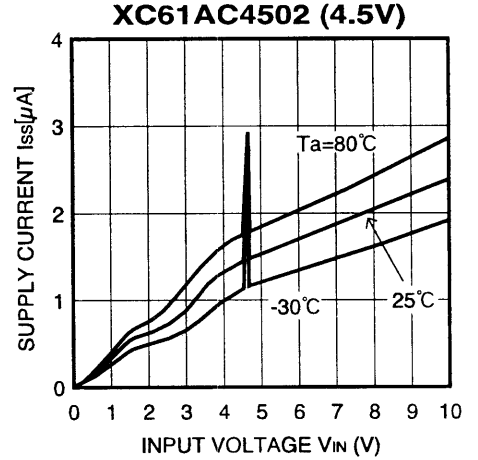
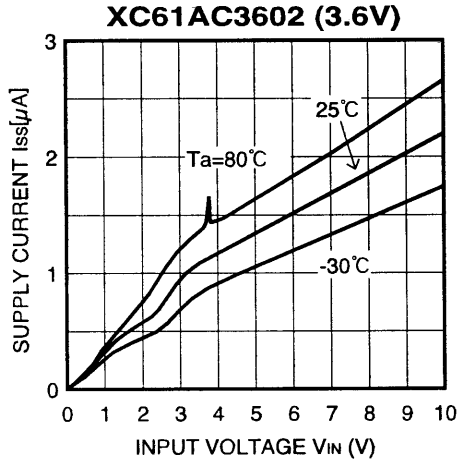
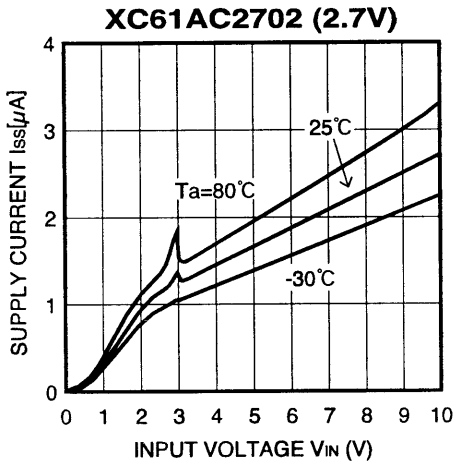

(2) DETECT & RELEASE VOLTAGE vs. TEMPERATURE

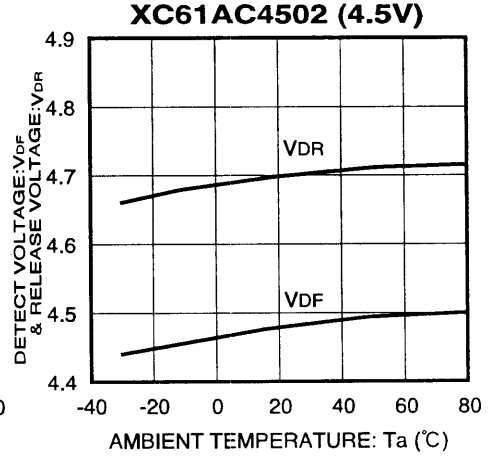
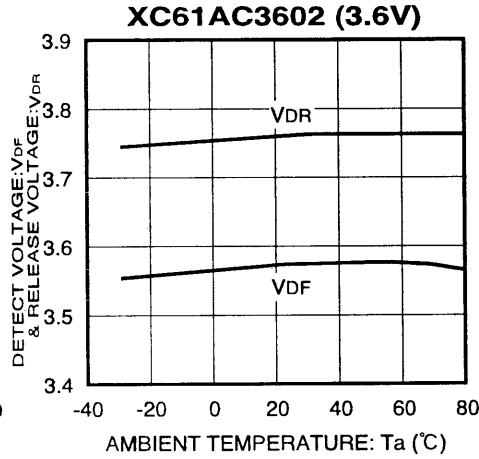
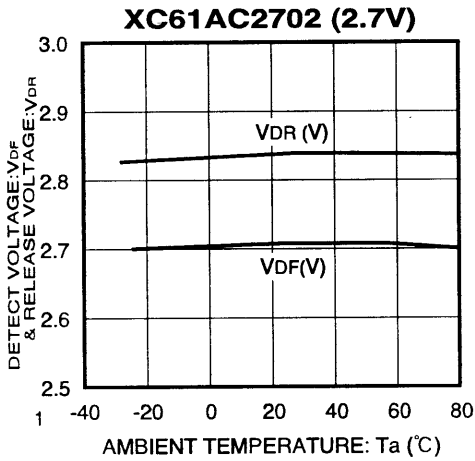

(3) OUTPUT VOLTAGE vs. INPUT VOLTAGE

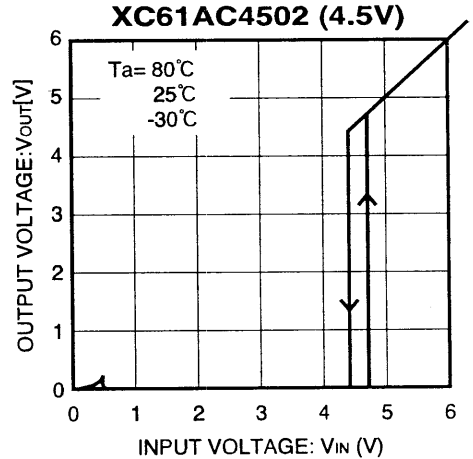
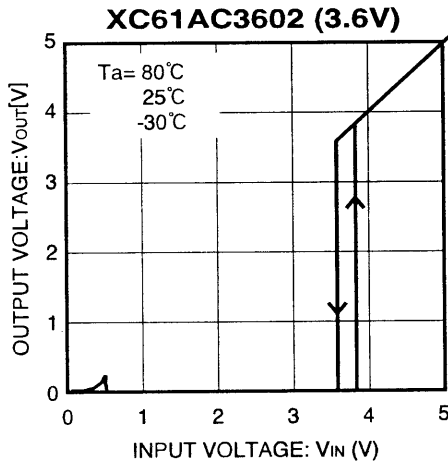
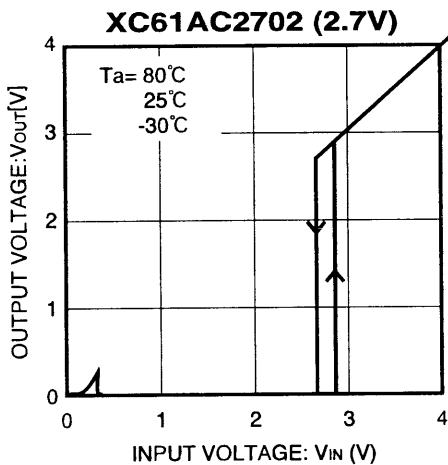

XC61AC Characteristics

(4) N-CH DRIVER OUTPUT CURRENT vs. V_{DS}

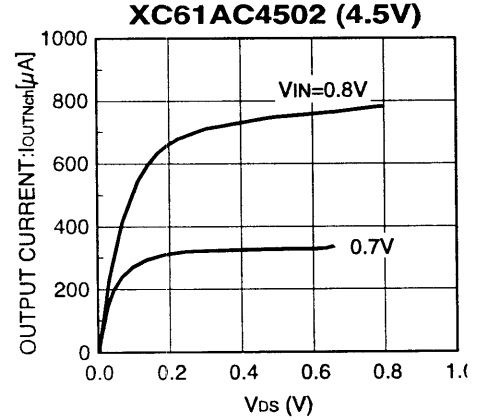
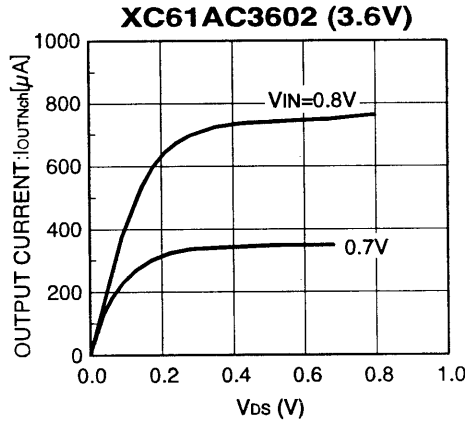
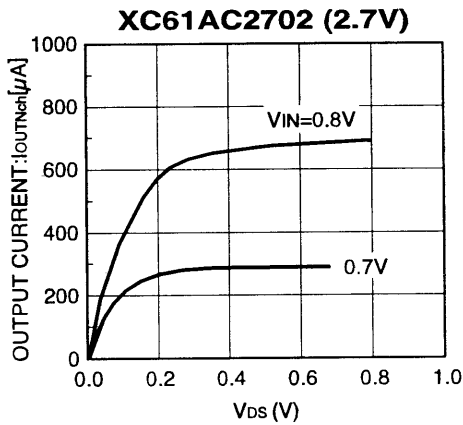
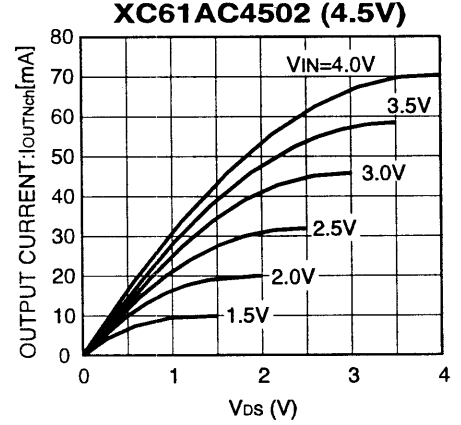
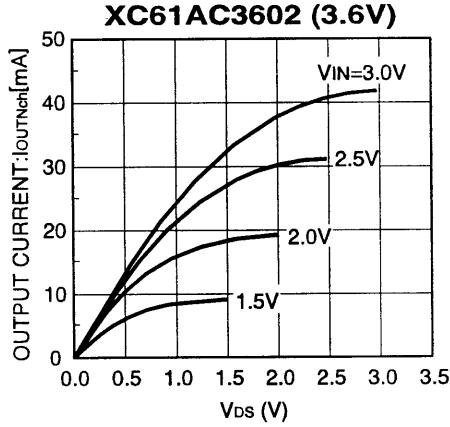
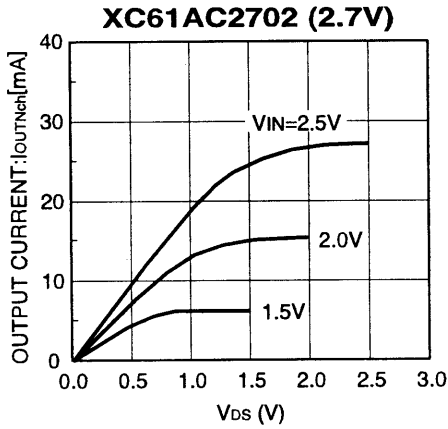

(5) N-CH DRIVER OUTPUT CURRENT vs. INPUT VOLTAGE

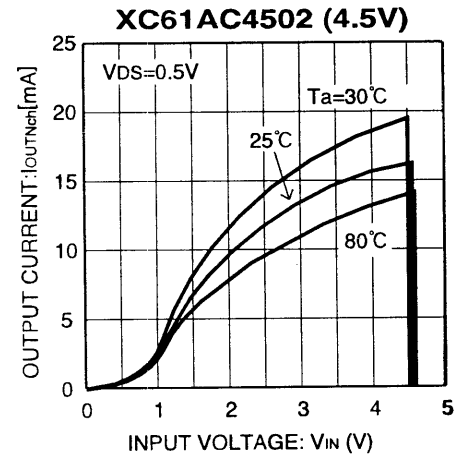
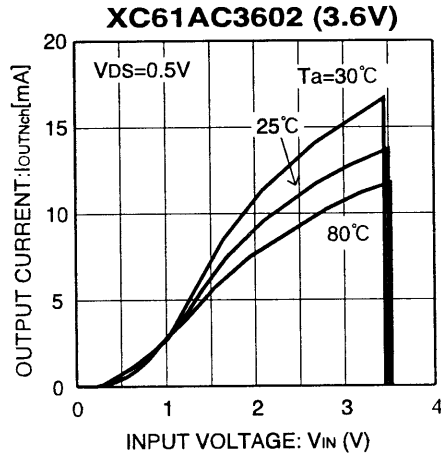
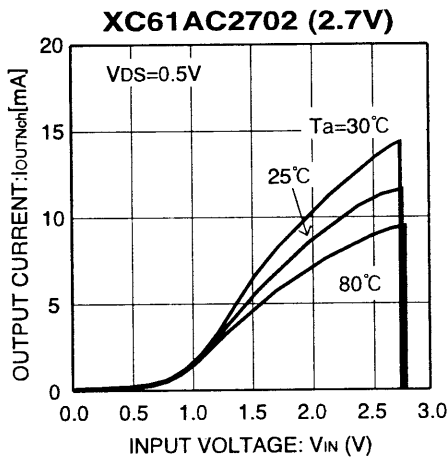

(6) P-CH DRIVER OUTPUT CURRENT vs. INPUT CURRENT

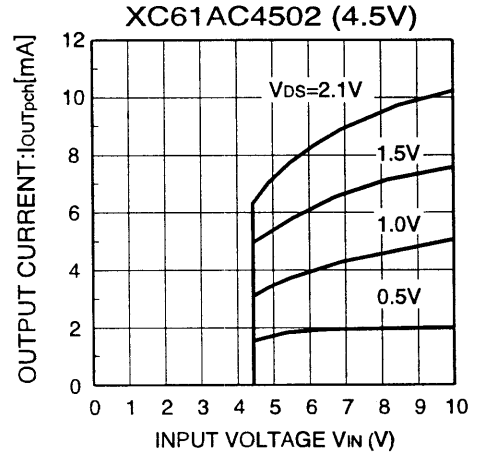
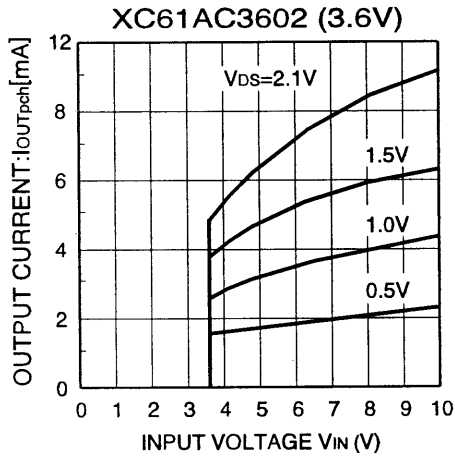
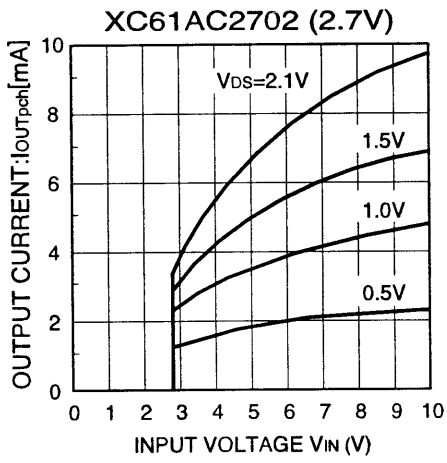

Packaging Information

All dimensions shown in mm.

SOT-23

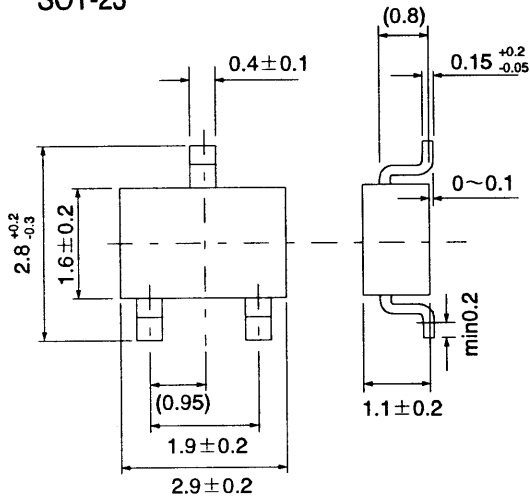

SOT-25

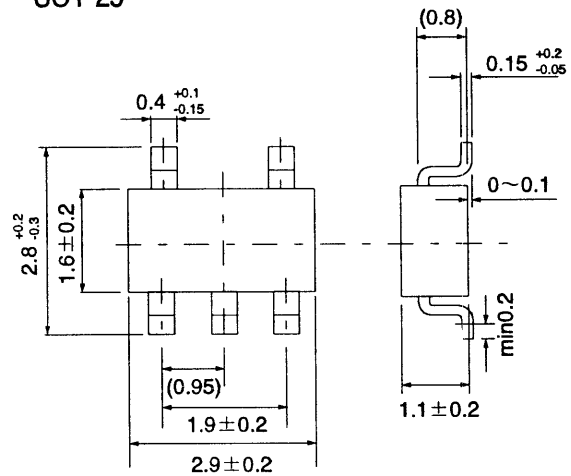

SOT-26

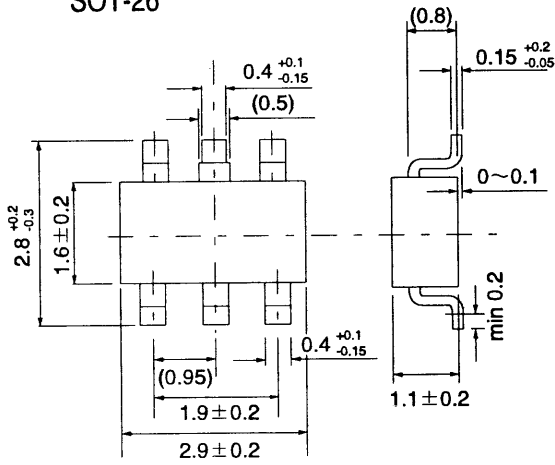

SOT-89

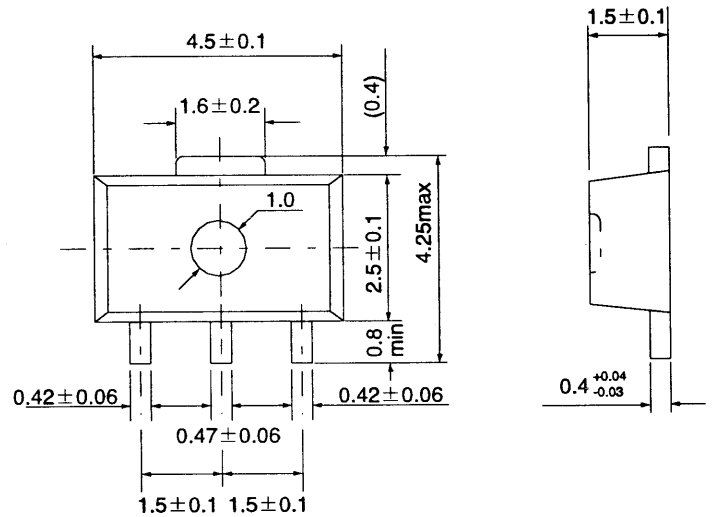

SOT-89-5

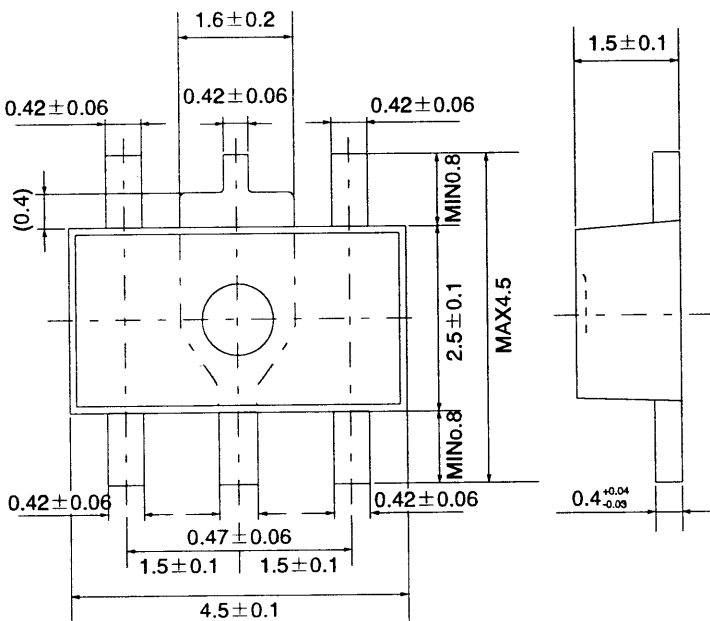

SOP-8

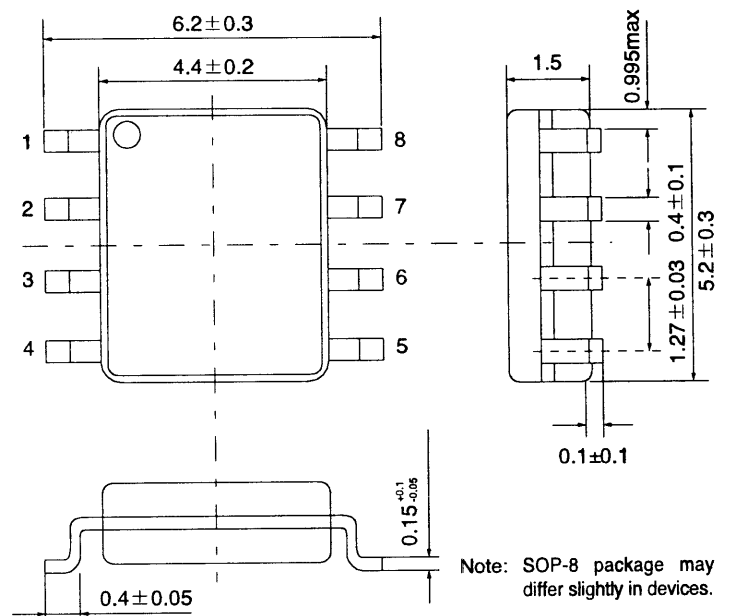

Note: SOP-8 package may differ slightly in devices.