

Home Products Quick Quote My Parts List Site Map Contact Us



EQUA34 Series Oscillator

Temperature Compensated Voltage Controlled Quartz Crystal Clock Oscillators TCVCXO LVCMOS (CMOS) 2.8Vdc 6 Pad 2.5mm x 3.2mm Ceramic Surface Mount (SMD)



Revision A 09/09/2015

Electrical Specifications

Nominal Frequency	10.000MHz to 200.000MHz <i>Some frequencies within this range may not be available.</i>
Frequency Stability	Inclusive of Operating Temperature Range, at $V_{DD}=2.8V_{DC}$, at $V_C=1.5V_{DC}$ $\pm 5.0\text{ppm}$ Maximum $\pm 3.0\text{ppm}$ Maximum $\pm 2.5\text{ppm}$ Maximum $\pm 2.0\text{ppm}$ Maximum $\pm 1.5\text{ppm}$ Maximum $\pm 1.0\text{ppm}$ Maximum
Frequency Stability vs. Frequency Tolerance	At $25^\circ\text{C} \pm 2^\circ\text{C}$, at $V_{DD}=2.8V_{DC}$, at $V_C=1.5V_{DC} \pm 0.1V_{DC}$, Pre-Reflow $\pm 2.0\text{ppm}$ Maximum $\pm 1.5\text{ppm}$ Maximum $\pm 1.0\text{ppm}$ Maximum
Frequency Stability vs. Input Voltage	$\pm 0.2\text{ppm}$ Maximum ($\pm 5\%$)
Frequency Stability vs. Load	$\pm 0.2\text{ppm}$ Maximum ($\pm 2\text{pF}$)
Frequency Stability vs. Reflow	$\pm 1.0\text{ppm}$ Maximum (at 25°C , 24 hours after reflow, 1 time)
Frequency Stability vs. Aging	$\pm 1\text{ppm/Year}$ Maximum (at 25°C)
Operating Temperature Range	0°C to $+50^\circ\text{C}$ -10°C to $+60^\circ\text{C}$ 0°C to $+70^\circ\text{C}$ -20°C to $+70^\circ\text{C}$ -30°C to $+60^\circ\text{C}$ -30°C to $+75^\circ\text{C}$ -30°C to $+85^\circ\text{C}$ -40°C to $+85^\circ\text{C}$
Supply Voltage	$2.8V_{DC} \pm 5\%$
Input Current	Unloaded 20mA Maximum over Nominal Frequency of 10MHz to 50MHz 25mA Maximum over Nominal Frequency of 50.000001MHz to 100MHz 30mA Maximum over Nominal Frequency of 100.000001MHz to 200MHz
Output Voltage Logic High (Voh)	$I_{OH} = -4\text{mA}$ 90% of V_{DD} Minimum
Output Voltage Logic Low (Vol)	$I_{OL} = +4\text{mA}$ 10% of V_{DD} Maximum
Rise/Fall Time	Measured at 10% to 90% of Waveform 3nSec Maximum
Duty Cycle	Measured at 50% of Waveform 50 $\pm 5\%$

Load Drive Capability	15pF Maximum
Output Logic Type	CMOS
Control Voltage	1.5V _{DC} ±1.0V _{DC}
Frequency Deviation	±8ppm Minimum
Linearity	10% Maximum
Transfer Function	Positive Transfer Characteristic
Modulation Bandwidth	Measured at -3dB 10kHz Minimum
Input Impedance	1MΩ Minimum
Phase Noise	Click to Open Phase Noise Table
Output Control Function	Output Enable (OE)
Output Control Input Voltage Logic High (V_{Ih})	90% of V _{DD} Minimum or No Connect to Enable Output
Output Control Input Voltage Logic Low (V_{Il})	10% of V _{DD} Maximum to Disable Output (High Impedance)
Output Enable Time	100nSec Maximum
Output Disable Time	50nSec Maximum
Output Enable Current	Without Load (Pin 2 = Ground) 15mA Maximum
RMS Phase Jitter	Click to Open RMS Phase Jitter Table
Period Jitter (Deterministic)	0.2pSec Typical
Period Jitter (Random)	2pSec Typical
Period Jitter (RMS)	3pSec Maximum
Period Jitter (pk-pk)	30pSec Maximum
Start Up Time	10mSec Maximum
Storage Temperature Range	-55°C to +125°C

Phase Noise

All Values are Typical

Nominal Frequency: 10MHz to 50MHz

<i>Offset</i>	<i>Phase Noise</i>
10Hz	-64dBc/Hz
100Hz	-96dBc/Hz
1kHz	-124dBc/Hz
10kHz	-131dBc/Hz
100kHz	-132dBc/Hz
1MHz	-149dBc/Hz
10MHz	-157dBc/Hz
20MHz	-159dBc/Hz

Nominal Frequency: 50.000001MHz to 100MHz

<i>Offset</i>	<i>Phase Noise</i>
10Hz	-58dBc/Hz
100Hz	-90dBc/Hz
1kHz	-118dBc/Hz
10kHz	-125dBc/Hz
100kHz	-126dBc/Hz
1MHz	-145dBc/Hz
10MHz	-155dBc/Hz
20MHz	-157dBc/Hz

Nominal Frequency: 100.000001MHz to 156.249999MHz

<i>Offset</i>	<i>Phase Noise</i>
10Hz	-57dBc/Hz
100Hz	-86dBc/Hz
1kHz	-114dBc/Hz
10kHz	-121dBc/Hz
100kHz	-122dBc/Hz
1MHz	-141dBc/Hz
10MHz	-151dBc/Hz
20MHz	-153dBc/Hz

Nominal Frequency: 156.25MHz to 200MHz

<i>Offset</i>	<i>Phase Noise</i>
10Hz	-58dBc/Hz
100Hz	-86dBc/Hz
1kHz	-110dBc/Hz
10kHz	-116dBc/Hz
100kHz	-117dBc/Hz
1MHz	-136dBc/Hz
10MHz	-146dBc/Hz
20MHz	-148dBc/Hz

RMS Phase Jitter

Fj=12kHz to 20MHz (Random)

<i>Nominal Frequency Range</i>	<i>RMS Phase Jitter</i>
10MHz to 50MHz	1.5pSec Maximum
50.000001MHz to 100MHz	1.4pSec Maximum
100.000001MHz to 200MHz	1.3pSec Maximum

Mechanical Dimensions

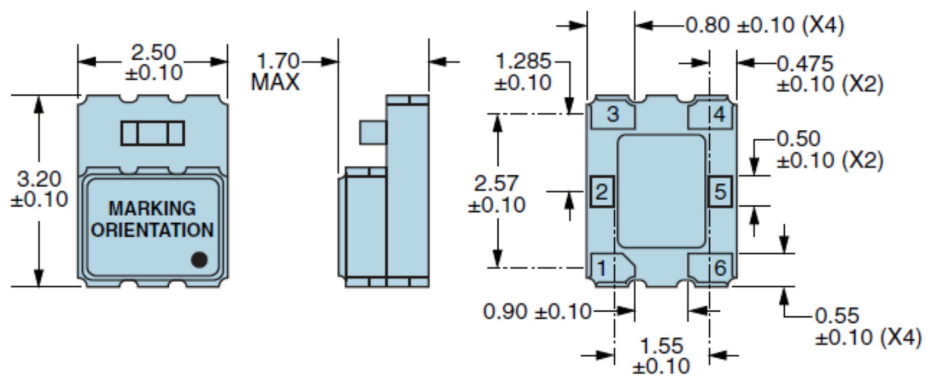

Terminal Plating Thickness: Gold (0.3 to 1.0 μ m) over Nickel (1.27 to 8.89 μ m).

All Dimensions in Millimeters

Pin 1: Control Voltage

Pin 2: Output Enable (OE)

Pin 3: Case/Ground

Pin 4: Output

Pin 5: Do Not Connect

Pin 6: Supply Voltage

Marking Specifications

Line 1:

EXXXXXX

- E = Ecliptek Designator
- XXXXXX = Nominal Frequency in MHz (5 digits + Decimal)

Line 2:

XXXXX

- XXXXX = Ecliptek Manufacturing Identifier

Environmental and Mechanical Specifications

ESD Susceptibility	MIL-STD-883, Method 3015, Class 1, HBM: 1500V
Fine Leak Test	MIL-STD-883, Method 1014, Condition A
Flammability	UL94-V0
Gross Leak Test	MIL-STD-883, Method 1014, Condition C
Mechanical Shock	MIL-STD-883, Method 2002, Condition B
Moisture Resistance	MIL-STD-883, Method 1004
Moisture Sensitivity	J-STD-020, MSL 1
Resistance to Soldering Heat	MIL-STD-202, Method 210, Condition K
Resistance to Solvents	MIL-STD-202, Method 215
Solderability	MIL-STD-883, Method 2003
Temperature Cycling	MIL-STD-883, Method 1010, Condition B
Vibration	MIL-STD-883, Method 2007, Condition A
Thermal Resistance (θ_{JA})	45°C/W (degrees Celsius per Watt)
Thermal Resistance (θ_{JC})	19°C/W (degrees Celsius per Watt)

Test Circuit for CMOS Output

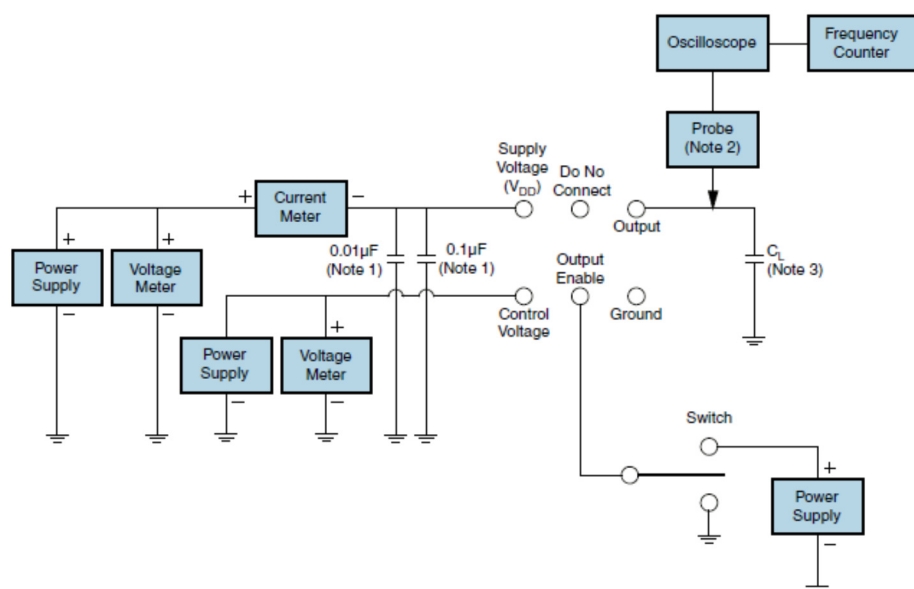

Note 1: An external $0.01\mu\text{F}$ ceramic bypass capacitor in parallel with a $0.1\mu\text{F}$ high frequency ceramic bypass capacitor close (less than 2mm) to the package ground and supply voltage pin is required.

Note 2: A low input capacitance ($<12\text{pF}$), 10X attenuation factor, high impedance ($>10\text{Mohms}$), and high bandwidth ($>300\text{MHz}$) passive probe is recommended.

Note 3: Capacitance value C_L includes sum of all probe and fixture capacitance.

Recommended Solder Pad Dimensions

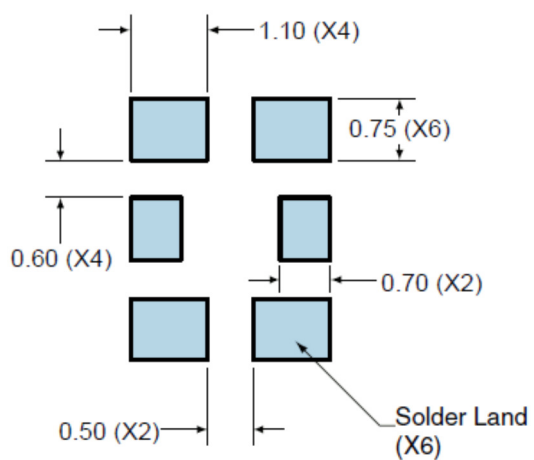

Tolerances = ± 0.1
All Dimensions in Millimeters

Solder Reflow Profile

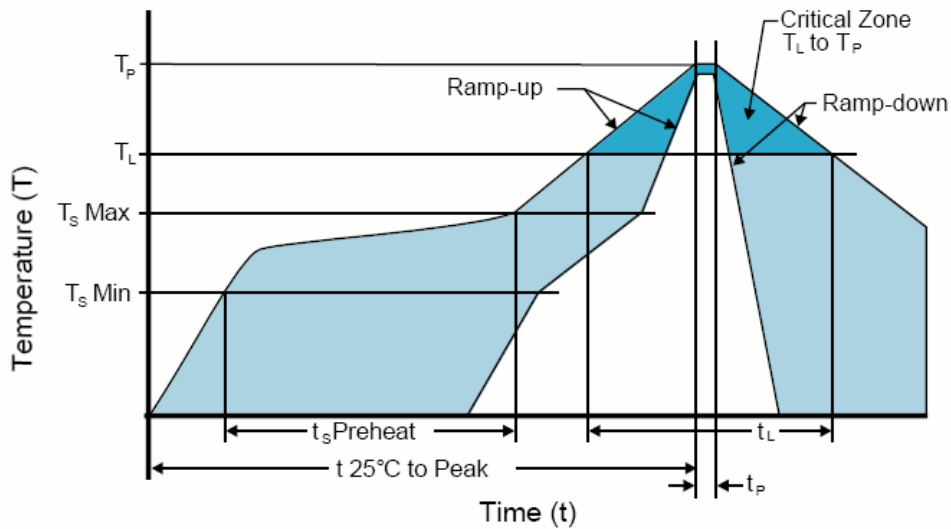

High Temperature Infrared/Convection

Note: Temperatures shown are applied to body of device.

T_S MAX to T_L (Ramp-up Rate)	3°C/Second Maximum
Preheat	
- Temperature Minimum (T _S MIN)	150°C
- Temperature Typical (T _S TYP)	175°C
- Temperature Maximum (T _S MAX)	200°C
- Time (t _s)	60 - 180 Seconds
Ramp-up Rate (T_L to T_P)	3°C/Second Maximum
Time Maintained Above:	
- Temperature (T _L)	217°C
- Time (t _L)	60 - 150 Seconds
Peak Temperature (T_P)	260°C Maximum for 10 Seconds Maximum
Target Peak Temperature (T_P Target)	250°C +0/-5°C
Time within 5°C of actual peak (t_p)	20 - 40 Seconds
Ramp-down Rate	6°C/Second Maximum
Time 25°C to Peak Temperature (t)	8 Minutes Maximum
Moisture Sensitivity Level	Level 1

Low Temperature Infrared/Convection 240°C

Note: Temperatures shown are applied to body of device.

T_S MAX to T_L (Ramp-up Rate)	5°C/Second Maximum
Preheat	
- Temperature Minimum (T _S MIN)	N/A
- Temperature Typical (T _S TYP)	150°C
- Temperature Maximum (T _S MAX)	N/A
- Time (t _S)	60 - 120 Seconds
Ramp-up Rate (T_L to T_P)	5°C/Second Maximum
Time Maintained Above:	
- Temperature (T _L)	150°C
- Time (t _L)	200 Seconds Maximum
Peak Temperature (T_P)	240°C Maximum
Target Peak Temperature (T_P Target)	240°C Maximum 2 Times / 230°C Maximum 1 Time
Time within 5°C of actual peak (t_p)	10 Seconds Maximum 2 Times / 80 Seconds Maximum 1 Time
Ramp-down Rate	5°C/Second Maximum
Time 25°C to Peak Temperature (t)	N/A
Moisture Sensitivity Level	Level 1

High Temperature Manual Soldering

Note: Temperatures shown are applied to body of device.
260°C Maximum for 5 Seconds Maximum, 2 times Maximum.

Low Temperature Manual Soldering

Note: Temperatures shown are applied to body of device.
185°C Maximum for 10 Seconds Maximum, 2 times Maximum.

1 - Build A Part Number

Select the parameters that meet your requirements and then click Next

Frequency in Megahertz (10 to 200):
Some frequencies within this range may not be available

Frequency Stability vs. Frequency Tolerance:

Operating Temperature Range:







Frequency Stability:

Packaging Options:

 Next

2 - Next Page

Access these Part Number specific resources and tools

-  [P/N Specific Data Sheet](#)
-  [Automated Quick Quote](#)
-  [Request Sample](#)
-  [Download IPC-1752](#)
-  [My Parts List !\[\]\(857406e19829adad1cf8e66fac11e2a2_img.jpg\)](#)
-  [My Part Number !\[\]\(128483df0d03e5950dab30368495e022_img.jpg\)](#)

Part Numbering Guide

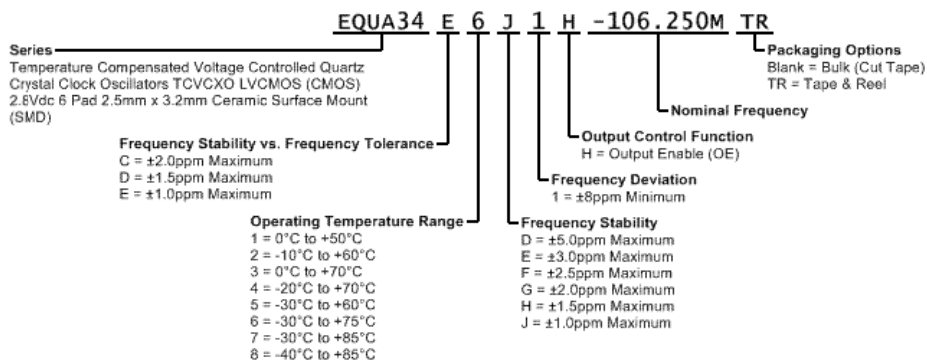

TOOLS

- [Quick Quote](#)
- [SmartSearch](#)
- [Compliance Documents](#)
- [Chipset Cross Reference](#)
- [Competitor Cross Reference](#)

PRODUCT

- [Crystals](#)
- [Oscillators](#)
- [Part Search](#)
- [REACH Resources](#)
- [RoHS Resources](#)
- [End of Life](#)

ECLIPTEK

- [Authorized Distributors](#)
- [Contact](#)
- [About](#)
- [News](#)
- [Our Quality](#)
- [ISO9001](#)
- [Feedback](#)

TERMS

- [Privacy Policy](#)
- [Terms of Sale](#)
- [Legal](#)