

ohne Verriegelung
without interlocking

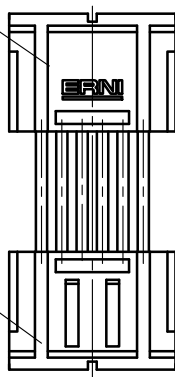

mit Verriegelung
with interlocking

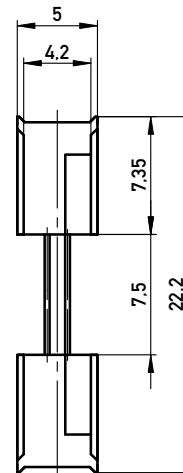
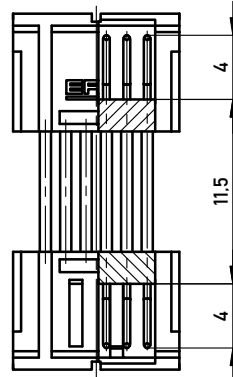
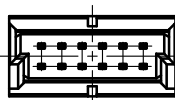

Verpackt in Tray -tray packaging
Verpackungseinheit 84 Stück -packaging unit 84

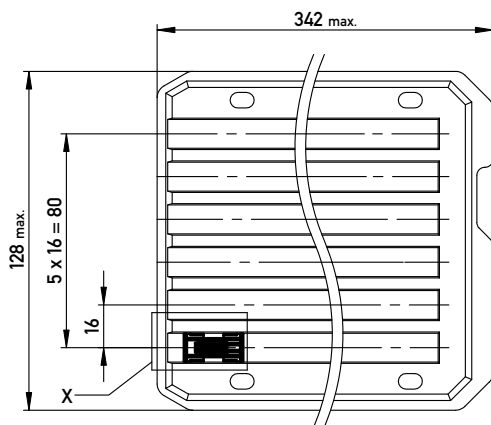

Einzelheit X (M 2:1)
detail X

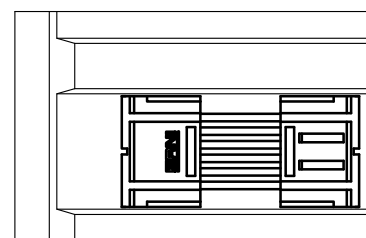

Adapterstück für board-to-board Abstand von 24mm (beidseitig verbaut mit Federleiste: 154805, Low Profile)
Adapter for board-to-board height 24mm (in combination with two female connectors: 154805, low profile)

Copyright by ERNI GmbH Proprietary notice pursuant to ISO 16016 to be observed.	Information:		Tolerances	 All Dimensions in mm	Scale	3:1
	All rights reserved. Only for Information. To ensure that this is the latest version of this drawing, please contact one of the ERNI companies before using.		Subject to modification without prior notice. Drawing will not be updated.		Designation 1,27 DRC Adapterstück BTB 24mm <i>12-polig</i>	
E01	25.06.2008	www.ERNI.com		364096		I
Index	Date			Class	DRCBTB	A3