

Transformers for LCD Backlight Inverter

Type: **FJ09M, 11M, 15M, 11MH, 18MH, 20MH, 23MH FJ10, FJ10L**

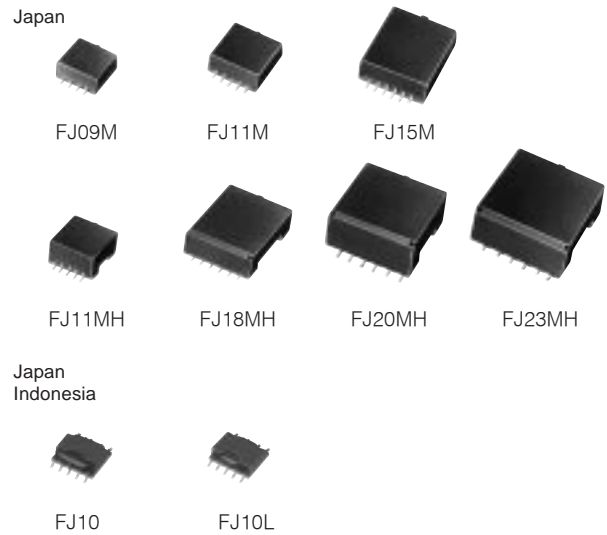

For backlighting inverter of LC Panel
Small, thin and high accuracy of dimensions

Industrial Property : Utility models 3 (pending)

■ Features

- Miniature and thin
- Excel in safety by molding structure
- Suitable for automatic mounter

■ Recommended Applications

- Color View Finders
- Digital still cameras
- Note type personal computers
- Word processors
- LCD TV
- High type (inch) LCD displays

■ Explanation of Part Numbers

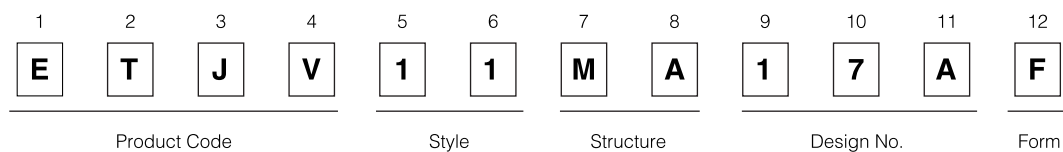

● FJ09M,11M,15M,11MH (Embossed Carrier Taping)

FJ10, FJ10L (Embossed Carrier Taping)

Quantity	500 pcs/1 reel	1000 pcs/1 reel
Quantity/shipping Box	1000 pcs/2 reels	2000 pcs/2 reels

● FJ18MH,20MH (Tray pack)

FJ23MH (Tray pack)

Quantity/shipping Box	200 pcs	100 pcs
-----------------------	---------	---------

Example of Applications

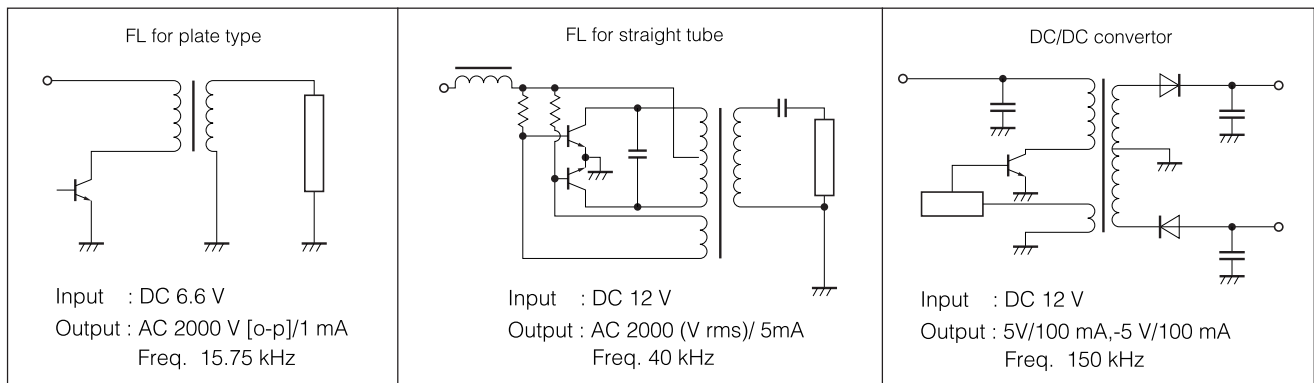

Example of Application Characteristics

Types	Input Volt. (V)	Max. Power (W)	Efficiency (%)	Open Volt.
FJ09M	3 to 6	1.0	75 to 85	2400 V[o-p]
FJ11M	3 to 12	2.0		1200 (V rms) max.
FJ15M	3 to 24	4.0	75 to 85	1600 (V rms) max.
FJ11MH	3 to 12	3.0		1200 (V rms) max.
FJ18MH	3 to 24	6.0		1800 (V rms) max.
FJ18MHV		4.0		2000 (V rms) max.
FJ20MH		10.0		2000 (V rms) max.
FJ23MH		18.0		2000 (V rms) max.
FJ23MHV		13.0		2100 (V rms) max.
FJ10		3 to 6		1.5
FJ10L				

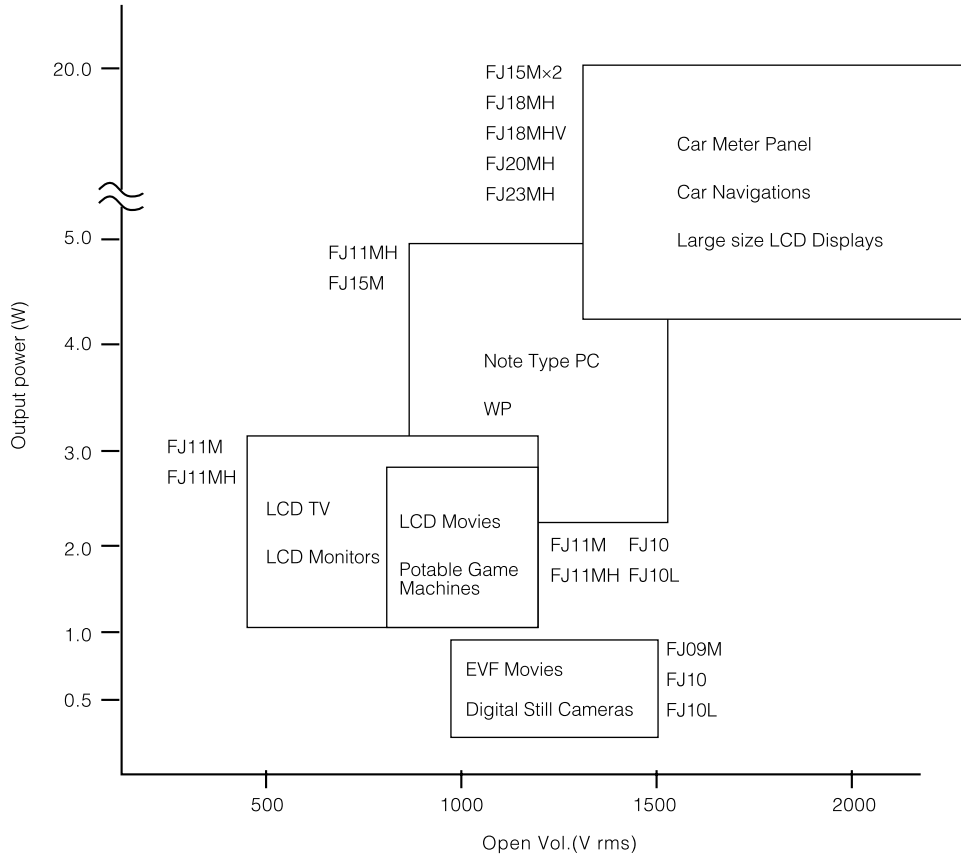

■ Dimensions in mm (not to scale)

FJ09M

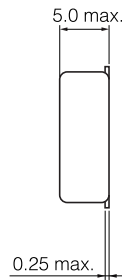
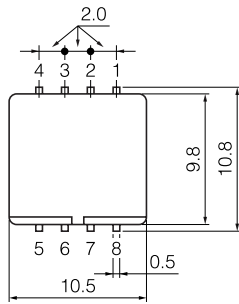

Recommended land pattern (Top View)

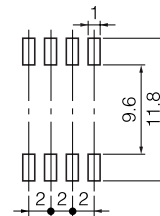

FJ11M

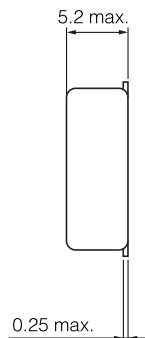
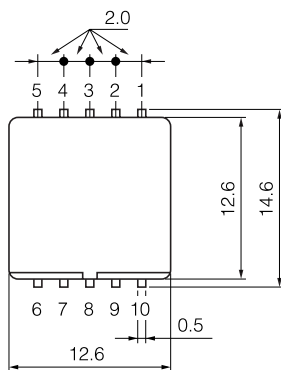

Recommended land pattern (Top View)

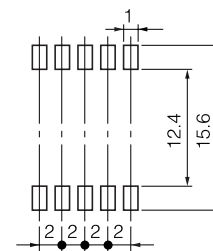

■ Dimensions in mm (not to scale)

FJ15M

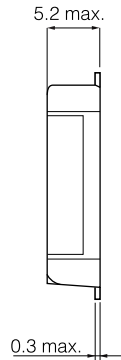
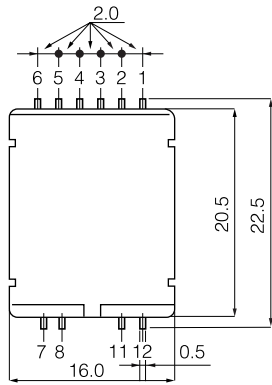

Recommended land pattern (Top View)

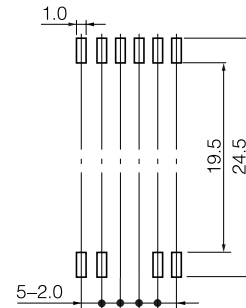

FJ11MH

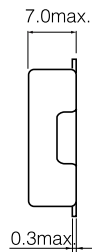
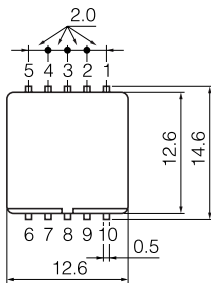

Recommended land pattern (Top View)

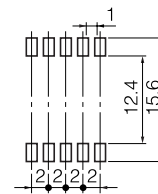

FJ18MH FJ18MHV

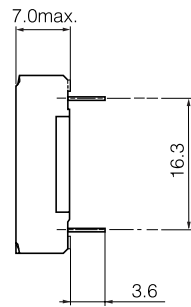
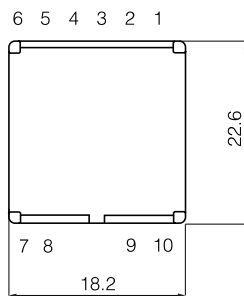

Recommended Piercing Plan (Top View)

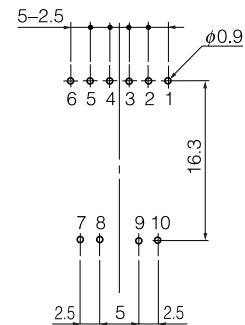

FJ20MH

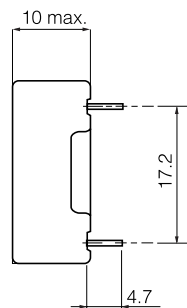
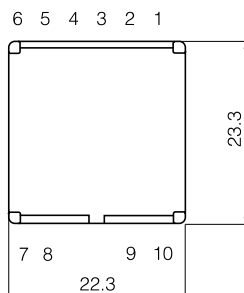

Recommended Piercing Plan (Top View)

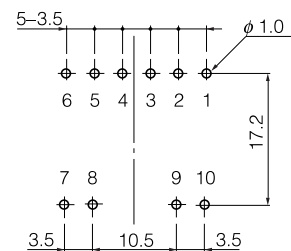

■ Dimensions in mm (not to scale)

FJ23MH
FJ23MHV

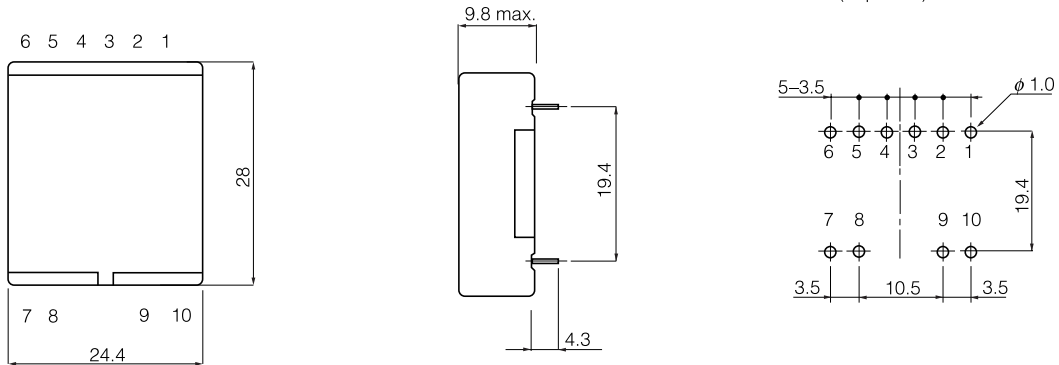

SMD type is available in FJ18MH, FJ20MH, and FJ23MH, too.

FJ10, FL10L

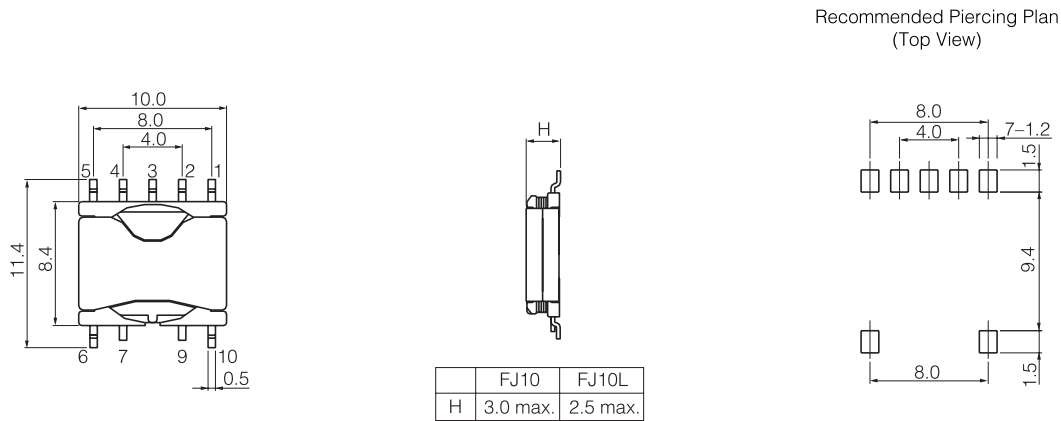

⚠ Cautions for use

This product is a transformer generated high voltage. If taking the wrong handling, there may occur a danger of electric shock and smoking, etc.

For reliability and safety, consider following caution items.

1. When using the products, user is recommended to confirm and evaluate the products in actual conditions. If abnormal operations should happen, the products may occur unusual smell, sound and smoking, etc. Consider the design including protective circuit.
2. There is a danger of electric shock if touching the products in operation.
3. Applying excessive pressure, vibration and shock, the products may be damaged in the electric and magnetic performance.
4. Inform us when using cleaning process because some ultrasonic cleaning or some cleaning solvent out of CFC may damage the products.
5. Be careful not to store them under high temperature, high moisture, corrosive gases, or magnetic field.
6. At storage exceeding 1 year, use the products after inspecting the outer structure because oxidation or a decline in the solderability may occur.