

**SN5414, SN54LS14,
SN7414, SN74LS14
HEX SCHMITT-TRIGGER INVERTERS**
DECEMBER 1983—REVISED MARCH 1988

- Operation from Very Slow Edges
- Improved Line-Receiving Characteristics
- High Noise Immunity

description

Each circuit functions as an inverter, but because of the Schmitt action, it has different input threshold levels for positive (V_{T+}) and for negative going (V_{T-}) signals.

These circuits are temperature-compensated and can be triggered from the slowest of input ramps and still give clean, jitter-free output signals.

The SN5414 and SN54LS14 are characterized for operation over the full military temperature range of -55°C to 125°C . The SN7414 and the SN74LS14 are characterized for operation from 0°C to 70°C .

logic symbol†

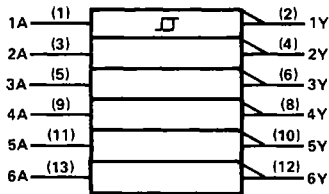

† This symbol is in accordance with ANSI/IEEE Std 91-1984 and IEC Publication 617-12.

Pin numbers shown are for D, J, N, and W packages

logic diagram (positive logic)

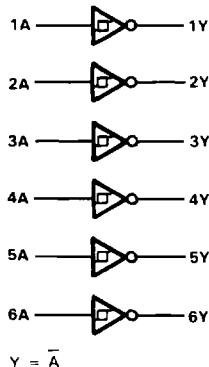

SN5414, SN54LS14 . . . J OR W PACKAGE
SN7414 . . . N PACKAGE
SN74LS14 . . . D OR N PACKAGE
(TOP VIEW)

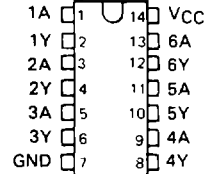

SN54LS14 . . . FK PACKAGE
(TOP VIEW)

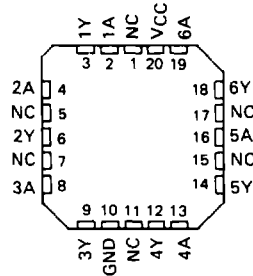

NC—No internal connection

SN5414, SN54LS14, SN7414, SN74LS14 HEX SCHMITT-TRIGGER INVERTERS

schematics

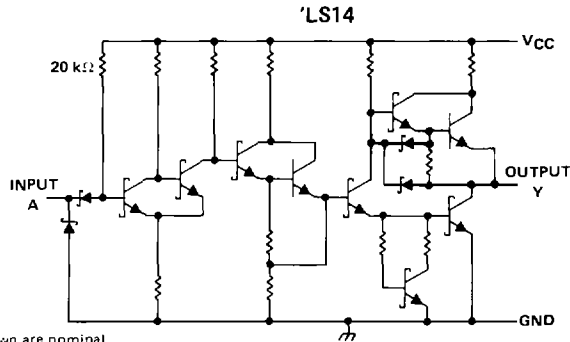
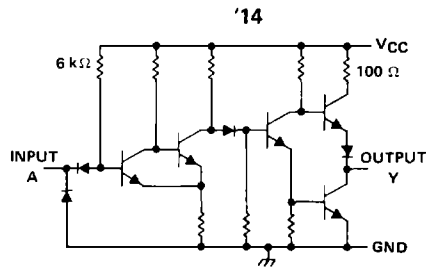

Resistor values shown are nominal.

absolute maximum ratings over operating free-air temperature range (unless otherwise noted)

Supply voltage, V_{CC} (see Note 1)	7 V
Input voltage: '14	5.5 V
'LS14	7 V
Operating free-air temperature: SN54'	-55°C to 125°C
SN74'	0°C to 70°C
Storage temperature range	-65°C to 150°C

NOTE 1: Voltage values are with respect to network ground terminal.

2 TTL Devices

SN5414, SN7414 HEX SCHMITT-TRIGGER INVERTERS

recommended operating conditions

	SN5414			SN7414			UNIT
	MIN	NOM	MAX	MIN	NOM	MAX	
V_{CC} Supply voltage	4.5	5	5.5	4.75	5	5.25	V
I_{OH} High-level output current			-0.8			-0.8	mA
I_{OL} Low-level output current			16			16	mA
T_A Operating free-air temperature	-55		125	0		70	$^{\circ}$ C

electrical characteristics over recommended operating free-air temperature range (unless otherwise noted)

PARAMETER	TEST CONDITIONS [†]	MIN	TYP [‡]	MAX	UNIT
V_{T+}	$V_{CC} = 5$ V	1.5	1.7	2	V
V_{T-}	$V_{CC} = 5$ V	0.6	0.9	1.1	V
Hysteresis ($V_{T+} - V_{T-}$)	$V_{CC} = 5$ V	0.4	0.8		V
V_{IK}	$V_{CC} = \text{MIN.}$, $I_I = -12$ mA			-1.5	V
V_{OH}	$V_{CC} = \text{MIN.}$, $V_I = 0.6$ V, $I_{OH} = -0.8$ mA	2.4	3.4		V
V_{OL}	$V_{CC} = \text{MIN.}$, $V_I = 2$ V, $I_{OL} = 16$ mA		0.2	0.4	V
I_{T+}	$V_{CC} = 5$ V, $V_I = V_{T+}$		-0.43		mA
I_{T-}	$V_{CC} = 5$ V, $V_I = V_{T-}$		-0.56		mA
I_I	$V_{CC} = \text{MAX.}$, $V_I = 5.5$ V			1	mA
I_{IH}	$V_{CC} = \text{MAX.}$, $V_{IH} = 2.4$ V			40	μ A
I_{IL}	$V_{CC} = \text{MAX.}$, $V_{IL} = 0.4$ V		-0.8	-1.2	mA
I_{OS} §	$V_{CC} = \text{MAX.}$	-18		-55	mA
I_{CCH}	$V_{CC} = \text{MAX.}$		22	36	mA
I_{CCL}	$V_{CC} = \text{MAX.}$		39	60	mA

[†] For conditions shown as MIN or MAX, use the appropriate value specified under recommended operating conditions.

[‡] All typical values are at $V_{CC} = 5$ V, $T_A = 25^{\circ}$ C.

§ Not more than one output should be shorted at a time.

switching characteristics, $V_{CC} = 5$ V, $T_A = 25^{\circ}$ C

PARAMETER	FROM (INPUT)	TO (OUTPUT)	TEST CONDITIONS	MIN	TYP	MAX	UNIT
t_{PLH}	A	Y	$R_L = 400 \Omega$, $C_L = 15$ pF		15	22	ns
t_{PHL}					15	22	ns

2

TTL Devices

SN54LS14, SN74LS14 HEX SCHMITT-TRIGGER INVERTERS

recommended operating conditions

	SN54LS14			SN74LS14			UNIT
	MIN	NOM	MAX	MIN	NOM	MAX	
V_{CC} Supply voltage	4.5	5	5.5	4.75	5	5.25	V
I_{OH} High-level output current			-0.4			-0.4	mA
I_{OL} Low-level output current			4			8	mA
T_A Operating free-air temperature	-55		125	0		70	°C

electrical characteristics over recommended operating free-air temperature range (unless otherwise noted)

PARAMETER	TEST CONDITIONS†	SN54LS14			SN74LS14			UNIT	
		MIN	TYP‡	MAX	MIN	TYP‡	MAX		
V_{T+}	$V_{CC} = 5\text{ V}$	1.4	1.6	1.9	1.4	1.6	1.9	V	
V_{T-}	$V_{CC} = 5\text{ V}$	0.5	0.8	1	0.5	0.8	1	V	
Hysteresis ($V_{T+} - V_{T-}$)	$V_{CC} = 5\text{ V}$	0.4	0.8		0.4	0.8		V	
V_{IK}	$V_{CC} = \text{MIN}$, $I_I = -18\text{ mA}$			-1.5			-1.5	V	
V_{OH}	$V_{CC} = \text{MIN}$, $V_I = 0.5\text{ V}$, $I_{OH} = -0.4\text{ mA}$	2.5	3.4		2.7	3.4		V	
V_{OL}	$V_{CC} = \text{MIN}$, $V_I = 1.9\text{ V}$			0.25	0.4		0.25	0.4	V
							0.35	0.5	
I_{T+}	$V_{CC} = 5\text{ V}$, $V_I = V_{T+}$			-0.14			-0.14	mA	
I_{T-}	$V_{CC} = 5\text{ V}$, $V_I = V_{T-}$			-0.18			-0.18	mA	
I_I	$V_{CC} = \text{MAX}$, $V_I = 7\text{ V}$			0.1			0.1	mA	
I_{IH}	$V_{CC} = \text{MAX}$, $V_{IH} = 2.7\text{ V}$			20			20	µA	
I_{IL}	$V_{CC} = \text{MAX}$, $V_{IL} = 0.4\text{ V}$			-0.4			-0.4	mA	
$I_{OS}\ddagger$	$V_{CC} = \text{MAX}$	-20		-100	-20		-100	mA	
I_{CCH}	$V_{CC} = \text{MAX}$		8.6	16		8.6	16	mA	
I_{CCL}	$V_{CC} = \text{MAX}$		12	21		12	21	mA	

† For conditions shown as MIN or MAX, use the appropriate value specified under recommended operating conditions.

‡ All typical values are at $V_{CC} = 5\text{ V}$, $T_A = 25^\circ\text{C}$.

§ Not more than one output should be shorted at a time, and duration of the short-circuit should not exceed one second.

switching characteristics, $V_{CC} = 5\text{ V}$, $T_A = 25^\circ\text{C}$

PARAMETER	FROM (INPUT)	TO (OUTPUT)	TEST CONDITIONS	MIN	TYP	MAX	UNIT
t_{PLH}	A	Y	$R_L = 2\text{ k}\Omega$, $C_L = 15\text{ pF}$	15	22		ns
t_{PHL}				15	22		ns

2

TTL Devices

SN5414, SN54LS14, SN7414, SN74LS14 HEX SCHMITT-TRIGGER INVERTERS

PARAMETER MEASUREMENT INFORMATION

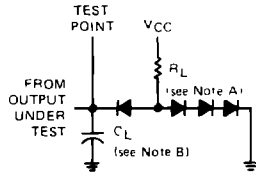

LOAD CIRCUIT

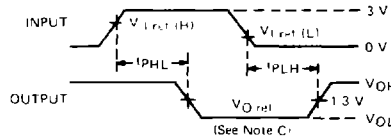

VOLTAGE WAVEFORMS

- NOTES A. All diodes are 1N3064 or equivalent.
B. C_L includes probe and jig capacitance
C. Generator characteristics and reference voltage are

	Generator Characteristics				Reference Voltages		
	Z_{out}	PRR	t_r	t_f	$V_{I\ ref(H)}$	$V_{I\ ref(L)}$	$V_{O\ ref}$
SN54 ⁺ /SN74 ⁺	50 Ω	1 MHz	10 ns	10 ns	1.7 V	0.9 V	1.5 V
SN54LS ⁺ /SN74LS ⁺	50 Ω	1 MHz	15 ns	6 ns	1.6 V	0.8 V	1.3 V

TYPICAL CHARACTERISTICS OF '14 CIRCUITS

POSITIVE-GOING THRESHOLD VOLTAGE
vs
FREE-AIR TEMPERATURE

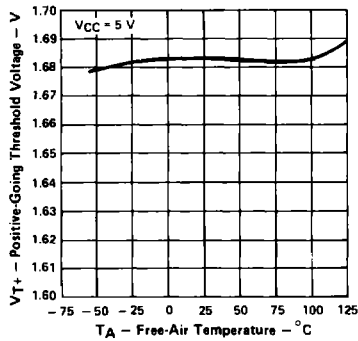

FIGURE 1

NEGATIVE-GOING THRESHOLD VOLTAGE
vs
FREE-AIR TEMPERATURE

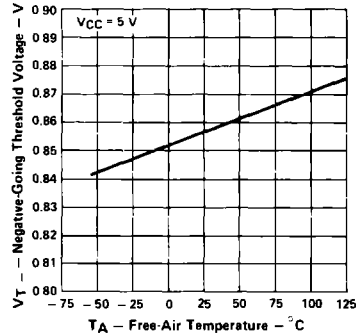

FIGURE 2

HYSTERESIS
vs
FREE-AIR TEMPERATURE

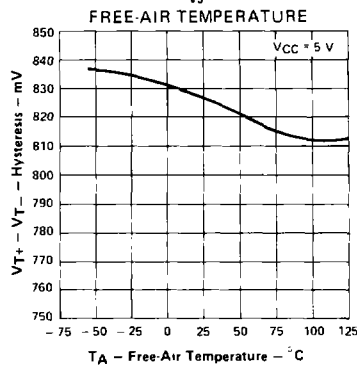

FIGURE 3

Data for temperatures below 0°C and 70°C and supply voltages below 4.75V and above 5.25V are applicable for SN5414 only.

SN5414, SN7414
HEX SCHMITT-TRIGGER INVERTERS

TYPICAL CHARACTERISTICS OF '14 CIRCUITS

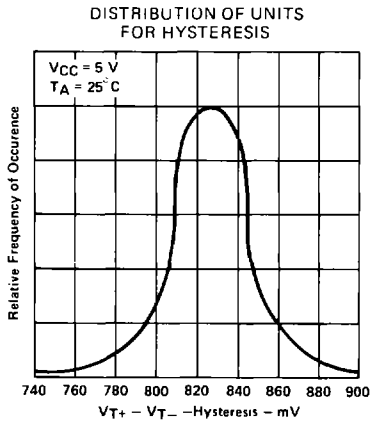

FIGURE 4

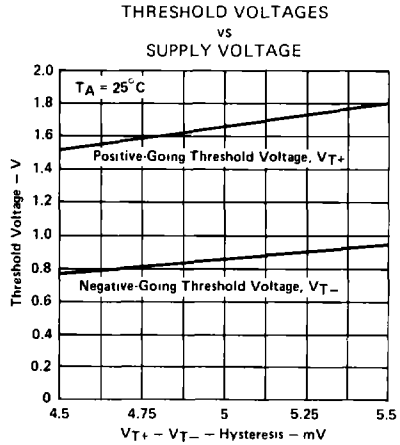

FIGURE 5

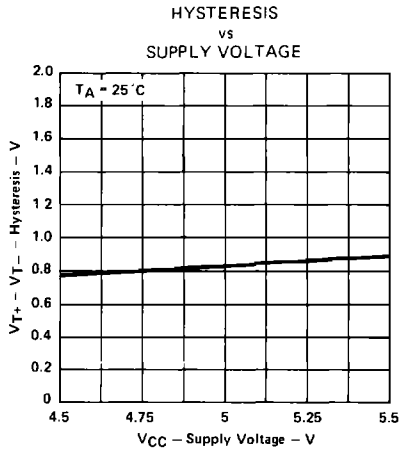

FIGURE 6

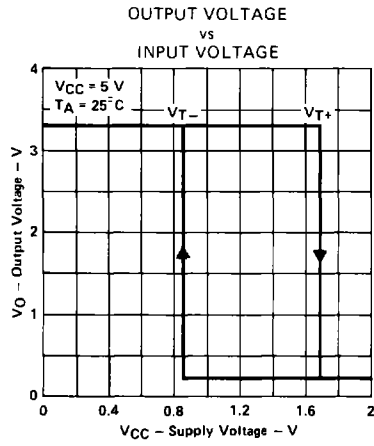

FIGURE 7

Data for temperatures below 0°C and 70°C and supply voltages below 4.75 V and above 5.25 V are applicable for SN5414 only.

TYPICAL CHARACTERISTICS OF 'LS14 CIRCUITS

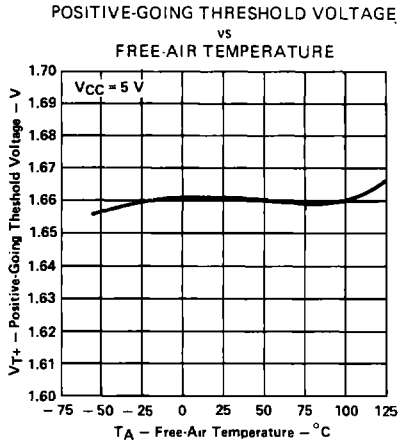

FIGURE 8

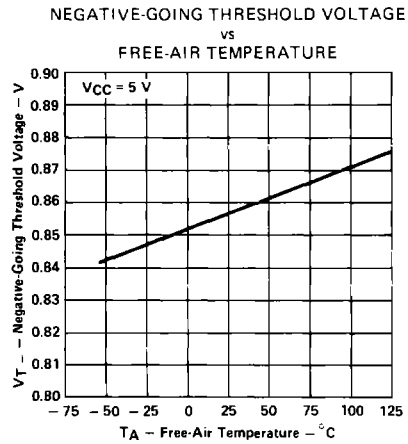

FIGURE 9

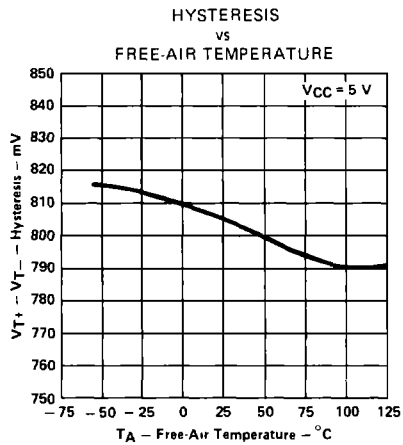

FIGURE 10

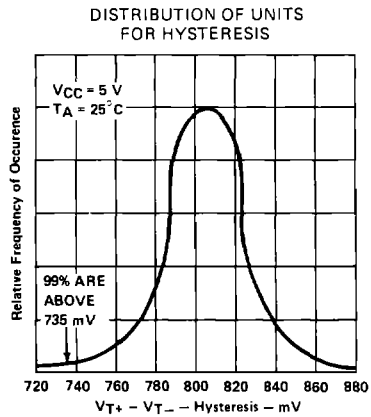

FIGURE 11

Data for temperatures below 0°C and above 70°C and supply voltages below 4.75 V and above 5.25 V are applicable for SN54LS14 only.

SN54LS14, SN74LS14
HEX SCHMITT-TRIGGER INVERTERS

TYPICAL CHARACTERISTICS OF 'LS14 CIRCUITS

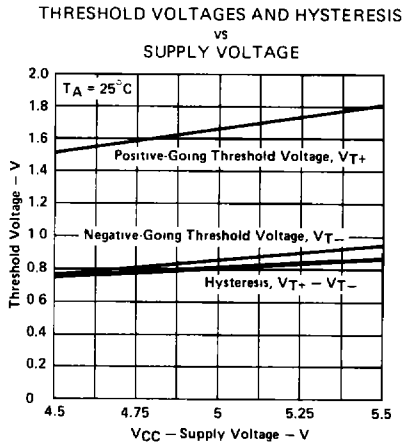

FIGURE 12

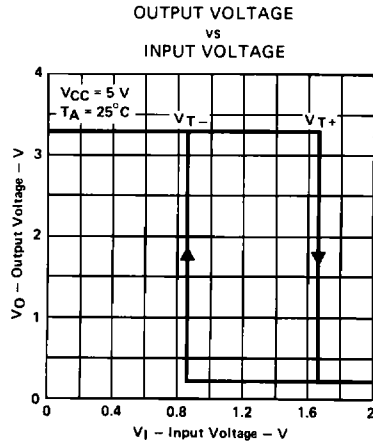

FIGURE 13

Data for temperatures below 0°C and above 70°C and supply voltages below 4.75 V and above 5.25 V are applicable for SN54LS14 only.

2 TTL Devices

SN5414, SN54LS14,
SN7414, SN74LS14
HEX SCHMITT-TRIGGER INVERTERS

TYPICAL APPLICATION DATA

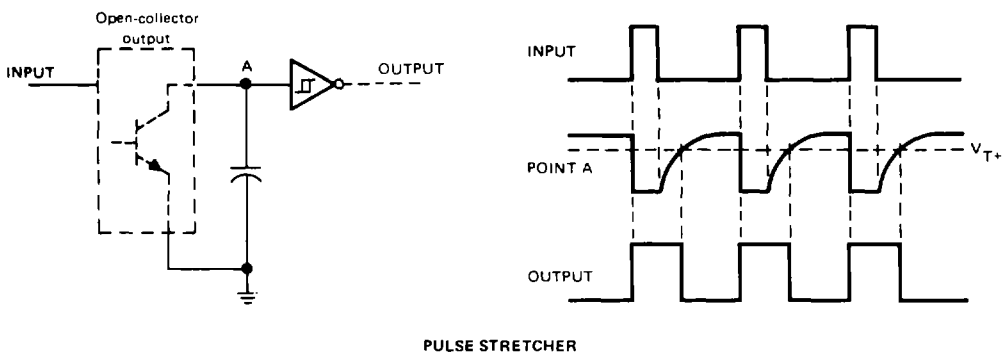
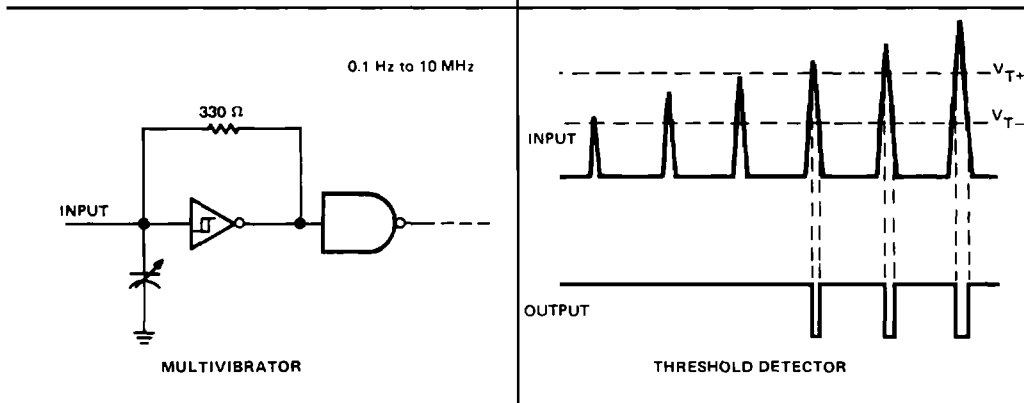
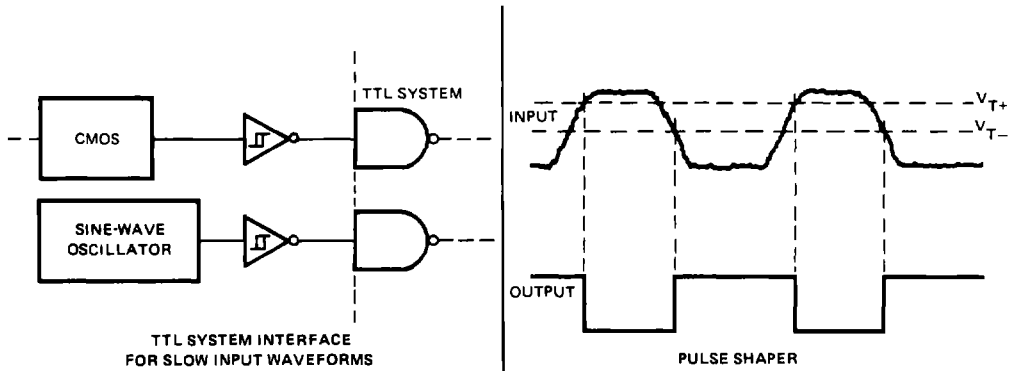

2

TTL Devices