

The microminiature series has been developed to meet the increasing demand for smaller connector size. This series is small, but still very rugged for its relative size.

The interface mating design insures precise outer shell alignment before engagement of the inner contacts. The OSMM series is compatible with smaller diameter semi-rigid cable.

Design and Construction:

All shell and body parts are made of stainless steel for ruggedness and long life. The dielectric is PTFE fluorocarbon. The center contacts are made of beryllium copper, gold plated. The coupling thread is .138-40 UNF thread.

Types:

The OSMM series connectors are available for appropriate size semi-rigid and flexible coaxial cables. Panel and bulkhead mount are also available to provide complete flexibility to component and system design.

Application:

Typical applications include requirements from low RF to high microwave frequencies. The higher order modeing for this series is above 450 GHz, but the primary feature is the microminiature size.

Table of Contents

OSMM Interface Mating Dimensions	92
Specifications	93
Coaxial Cable Types	94
Semi-Rigid	
Flexible	
Panel and Bulkhead Mount Receptacles	95
Turret Terminal	
Straight Terminal	
Printed Circuit	

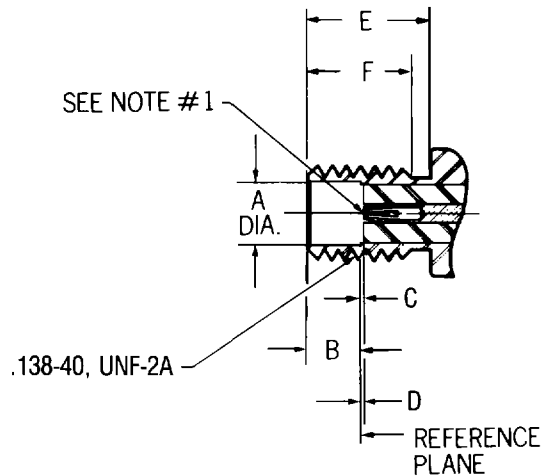
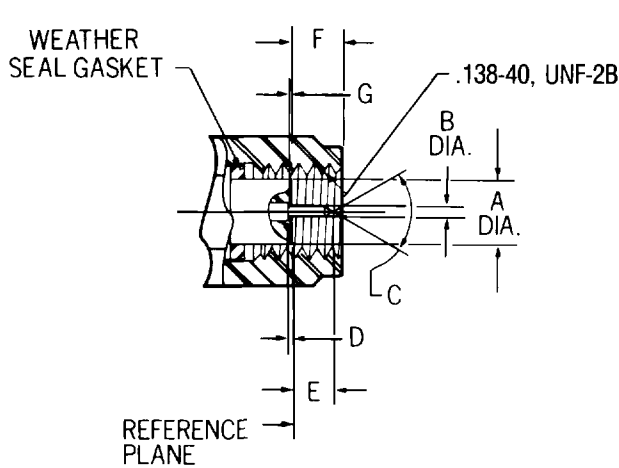

PLUG

Letter	Inches (Millimeters) ³	
	Minimum	Maximum
A	.0930 (2.36)	.0946 (2.43)
B	.0150 (0.38)	.0163 (0.42)
C	60°	90°
D	.000 (0.00)	.010 (0.25)
E	.055 (1.40)	.070 (1.78)
F	.065 (1.65)	.099 (2.29)
G	.000 (0.00)	.010 (0.25)

JACK

Letter	Inches (Millimeters) ³	
	Minimum	Maximum
A	.096 (2.44)	.097 (2.46)
B	.078 (1.98)	.082 (2.08)
C	.000 (0.00)	.010 (0.25)
D	.000 (0.00)	.010 (0.25)
E	.175 (4.45)	-
F	.140 (3.56)	-

1. ID to meet VSWR and contact resistance when mated with .0155 (+.0008/-0.0005) (0.0394 mm) dia. pin.
2. When fully engaged, the two reference planes must coincide with metal to metal contact.
3. Metric equivalents (to the nearest 0.01mm) are given for general information only.

Requirement	MIL-C-39012 Applicable Paragraph	Detail
General		
Material	3.3	Steel corrosion resistant per ASTM-A-582 and ASTM-A-484, Type 303. Beryllium copper per ASTM B 196. PTFE Fluorocarbon per ASTM-D-1457.
Finish	3.3.1	Center contacts shall be gold plated to a min. thickness of .00005 inch in accordance with MIL-G-45204, Typ I, Grade C. All other metal parts shall be finished as to provide a connector which meets the corrosion requirements.
Design	3.4	The design shall be such that the outline shown in this catalog and the interface dimensions of MIL-STD-348A are met.
Electrical		
Insulation Resistance	3.11	The insulation resistance shall not be less than 5,000 megohms.
Corona Level	3.22	The connector shall not exhibit breakdown when the voltage is 150 volts rms at 70,000 ft.
Dielectric Withstanding Voltage	3.17	The magnitude of the test voltage shall be 500 volts rms at sea level.
RF High Potential	3.23	The withstanding voltage is 375 volts rms at 5 MHz. Leakage current is not applicable.
Contact Resistance	3.16	Center contact resistance: 3.5 milliohms max. Outer contact resistance: 2.8 milliohms max.
VSWR	3.14	No military slash sheet applies. Consult factory. Frequency range dependent on cable used.
RF Leakage	3.26	No military slash sheet applies. Consult factory.
Insertion Loss	3.27	No military slash sheet applies. Consult factory. Frequency range dependent on cable used.
Mechanical		
Force to Engage	3.5.1	The torque required to engage and disengage shall not exceed 1 in.-lbs. The longitudinal force is not applicable.
Coupling Nut Retention	3.25	40 lbs. min. Applicable for plug connectors only.
Coupling Proof Torque	3.6	4 in.-lbs. min. Applicable for plug connectors only.
Cable Retention	3.24	No military slash sheet applies. Consult factory.
Mating Characteristics	3.7	Applicable to jack connectors only. Oversize pin .0165 min. dia., .045 deep; insertion force 3 lbs. max. with .0163 min. dia. pin; withdrawal force 0.5 oz. min. with .015 max. dia. pin.
Connector Durability	3.15	The connector to be tested and its mating connector shall be subjected to 500 insertion and withdrawal cycles at 12 cycles per minute max. The connector shall show no evidence of mechanical failure and shall meet the mating characteristic requirements.
Recommended Mating Torque	—	2 in.-lbs.
Environmental		
Vibration	3.18	Specification MIL-STD-202, method 204, test condition D.
Shock	3.19	Specification MIL-STD-202, method 213, test condition I.
Thermal Shock	3.20	No military slash sheet applies. Consult factory.
Corrosion (Salt Spray)	3.13	Specification MIL-STD-202, method 101, test condition B.
Moisture Resistance	3.21	Specification MIL-STD-202, method 106. No measurements at high humidity. Insulation resistance shall be at least 200 megohms within 5 minutes of removal from humidity.

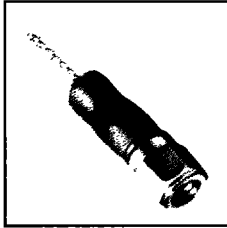

Straight Cable Plug

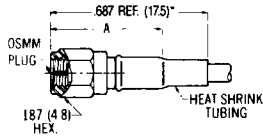

Cable	RG 196/U Flexible	.034 Dia.* Semi-Rigid	.047 Dia.* Semi Rigid
Attachment	Crimp	Direct Solder	Direct Solder
Part Number	4031-7196-00	4001-7934-00	4001-7947-00
Dim. A	Inches (mm) .450 Ref. (11.4)	Inches (mm) .360 Ref. (9.2)	Inches (mm) .360 Ref. (9.2)

* Semi-rigid versions do not use heat shrink tubing.
Finish: Gold plate. For passivated stainless steel coupling nut, change the Part Number suffix from -00 to -02.
Refer to Appendix for Coaxial Cable Characteristics.
Refer to recommended assembly tools in Tool Section.

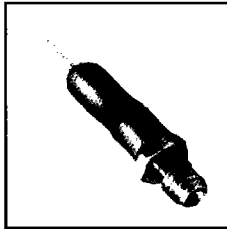

Straight Cable Jack

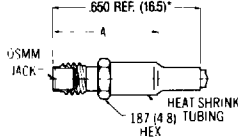

Cable	RG 196/U Flexible	.034 Dia.* Semi-Rigid	.047 Dia.* Semi Rigid
Attachment	Crimp	Direct Solder	Direct Solder
Part Number	4032-7196-00	4002-7934-00	4002-7947-00
Dim. A	Inches (mm) .437 Ref. (11.1)	Inches (mm) .330 Ref. (8.4)	Inches (mm) .330 Ref. (8.4)

* Semi-rigid versions do not use heat shrink tubing.
Finish: Gold plate.
Refer to Appendix for Coaxial Cable Characteristics.
Refer to recommended assembly tools in Tool Section.

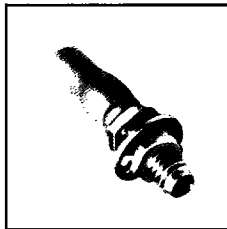

Bulkhead Feedthrough Cable Jack

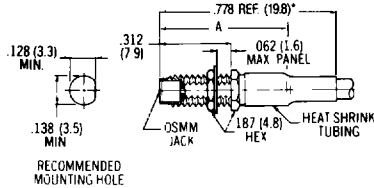

Cable	RG 196/U Flexible	.034 Dia.* Semi-Rigid	.047 Dia.* Semi Rigid
Attachment	Crimp	Direct Solder	Direct Solder
Part Number	4034-7196-00	4004-7934-00	4004-7947-00
Dim. A	Inches (mm) .565 Ref. (14.4)	Inches (mm) .458 Ref. (11.6)	Inches (mm) .458 Ref. (11.6)

* Semi-rigid versions do not use heat shrink tubing.
Finish: Gold plate.
Refer to Appendix for Coaxial Cable Characteristics.
Refer to recommended assembly tools in Tool Section.

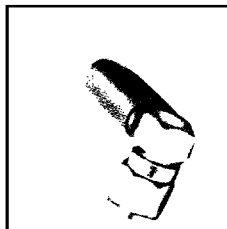

Right Angle Cable Plug

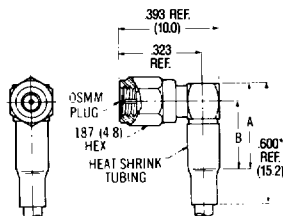

Cable	RG 196/U Flexible	.034 Dia.* Semi-Rigid	.047 Dia.* Semi Rigid
Attachment	Crimp	Direct Solder	Direct Solder
Part Number	4037-7196-00	4007-7934-00	4007-7947-00
Dim. A	Inches (mm) .363 Ref. (9.2)	Inches (mm) .256 Ref. (6.5)	Inches (mm) .256 Ref. (6.5)
Dim. B	.285 Ref. (7.2)	.178 Ref. (4.5)	.178 Ref. (4.5)

* Semi-rigid versions do not use heat shrink tubing.
Finish: Gold plate. For passivated stainless steel coupling nut, change the Part Number suffix from -00 to -02.
Refer to Appendix for Coaxial Cable Characteristics.
Refer to recommended assembly tools in Tool Section.

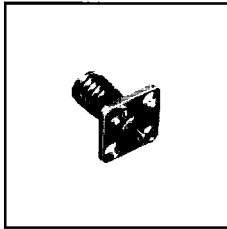

Flange Mount Jack

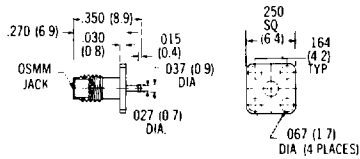

Captured Center Contact* Turret Terminal	
Part Number	4052-0000-00

Finish: Gold plate. For passivated stainless steel, change the Part Number suffix from -00 to -02.
* Contact captivation per U.S. patent number 3,292,117.

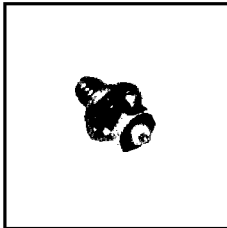

Bulkhead Feedthrough Jack

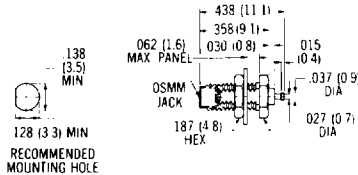

Captured Center Contact* Turret Terminal Rear Mount	
Part Number	4056-0000-00

Finish: Gold plate. For passivated stainless steel, change the Part Number suffix from -00 to -02.
* Contact captivation per U.S. patent number 3,292,117.

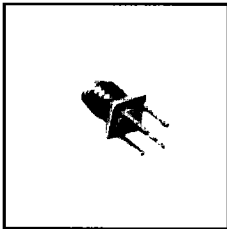

Printed Circuit Board Straight Jack

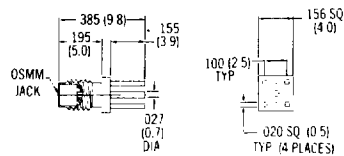

Captured Center Contact* Straight Terminal	
Part Number	4062-0000-00

Finish: Gold plate.
* Contact captivation per U.S. patent number 3,292,117.

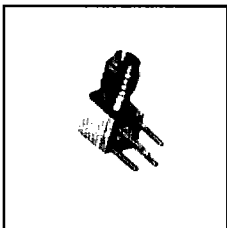

Printed Circuit Board Right Angle Jack

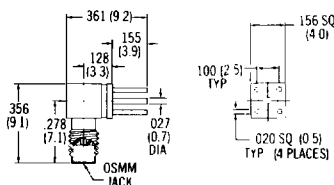

Captured Center Contact Straight Terminal	
Part Number	4064-0000-00

Finish: Gold plate. For passivated stainless steel, change the Part Number suffix from -00 to -02.