



600 V IL4216 700 V IL4217 800 V IL4218 Triac Optocoupler

FEATURES

- High Input Sensitivity $I_{FT}=1.3$ mA
- 600/700/800 V Blocking Voltage
- 300 mA On-State Current
- High Static dv/dt 10,000 V/ μ sec., typical
- Inverse Parallel SCRs Provide Commutating $dv/dt >10$ kV/ μ sec
- Very Low Leakage <10 μ A
- Isolation Test Voltage from Double Molded Package 5300 V_{RMS}
- Package, 6-Pin DIP
- Underwriters Lab File #E52744
- VDE Approval #0884 Available with Option 1

DESCRIPTION

The IL421x consists of an AlGaAs IRLLED optically coupled to a pair of photosensitive non-zero crossing SCR chips and are connected inversely parallel to form a TRIAC. These three semiconductors are assembled in a six pin 0.3 inch dual in-line package, using high insulation double molded, over/under leadframe construction.

High input sensitivity is achieved by using an emitter follower phototransistor and a cascaded SCR pre-driver resulting in an LED trigger current of less than 1.3 mA (DC).

The IL421x uses two discrete SCRs resulting in a commutating dv/dt of greater than 10 kV/ μ s. The use of a proprietary dv/dt clamp results in a static dv/dt of greater than 10 kV/ μ s. This clamp circuit has a MOS-FET that is enhanced when high dv/dt spikes occur between MT1 and MT2 of the TRIAC. The FET clamps the base of the phototransistor when conducting, disabling the internal SCR pre-driver.

The blocking voltage of up to 800 V permits control of off-line voltages up to 240 VAC, with a safety factor of more than two, and is sufficient for as much as 380 VAC. Current handling capability is up to 300 mA RMS, continuous at 25°C.

The IL421x isolates low-voltage logic from 120, 240, and 380 VAC lines to control resistive inductive, or capacitive loads including motors solenoids, high current thyristors or TRIAC and relays.

Applications include solid-state relays, industrial controls, office equipment, and consumer appliances.

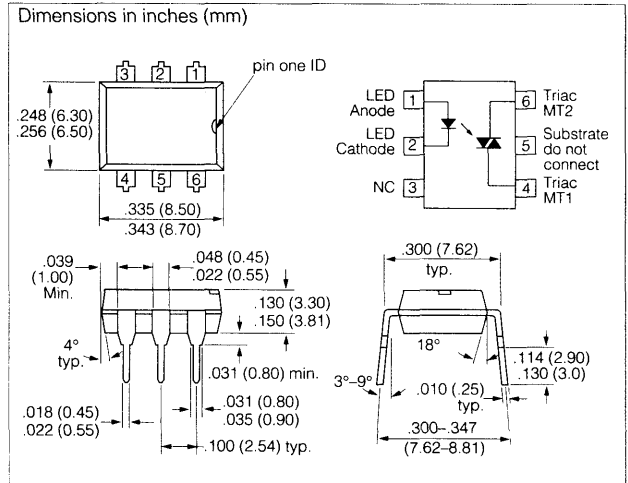

Maximum Ratings

Emitter

Reverse Voltage	6.0 V
Forward Current	60 mA
Surge Current	2.5 A
Power Dissipation	100 mW
Derate Linearly from 25°C	1.33 mW/°C
Thermal Resistance	750 °C/W

Detector

Peak Off-State Voltage	
IL4216	600 V
IL4217	700 V
IL4218	800 V
RMS On-State Current	300 mA
Single Cycle Surge	3.0 A
Total Power Dissipation	500 mW
Derate Linearly from 25°C	6.6 mW/°C
Thermal Resistance	150°C/W

Package

Lead Soldering Temperature	260°C/5.0 sec.
Creepage Distance	≥ 7.0 mm
Clearance	≥ 7.0 mm
Storage Temperature	-55°C to +150°C
Operating Temperature	-55°C to +100°C
Isolation Test Voltage	5300 V _{RMS}
Isolation Resistance	
$V_{IO}=500$ V, $T_A=25$ °C	$\geq 10^{12}$ Ω
$V_{IO}=500$ V, $T_A=100$ °C	$\geq 10^{11}$ Ω

Characteristics $T_A=25^\circ\text{C}$

Parameter	Symbol	Min.	Typ.	Max.	Unit	Condition
Emitter						
Forward Voltage	V_F	—	1.3	1.5	V	$I_F=20\text{ mA}$
Breakdown Voltage	V_{BR}	6.0	30	—	V	$I_R=10\text{ mA}$
Reverse Current	I_R	—	0.1	10	μA	$V_R=6.0\text{ V}$
Capacitance	C_O	—	40	—	pF	$V_F=0\text{ V}$, $f=1.0\text{ MHz}$
Thermal Resistance, Junction to Lead	R_{THJL}	—	750	—	K/W	—
Output Detector						
Repetitive Peak Off-State Voltage IL4216 IL4217 IL4218	V_{DRM} V_{DRM} V_{DRM}	600 700 800	650 750 850	—	V V V	$I_{DRM}=100\text{ }\mu\text{A}$ $I_{DRM}=100\text{ }\mu\text{A}$ $I_{DRM}=100\text{ }\mu\text{A}$
Off-State Voltage IL4216 IL4217 IL4218	$V_{D(RMS)}$ $V_{D(RMS)}$ $V_{D(RMS)}$	424 484 565	460 536 613	—	V V V	$I_{D(RMS)}=70\text{ }\mu\text{A}$ $I_{D(RMS)}=70\text{ }\mu\text{A}$ $I_{D(RMS)}=70\text{ }\mu\text{A}$
Off-State Current	$I_{D(RMS)}$	—	10	100	μA	$V_D=600\text{ V}$, $T_A=100^\circ\text{C}$
Reverse Current	$I_{R(RMS)}$	—	10	100	μA	$V_R=600\text{ V}$, $T_A=100^\circ\text{C}$
On-State Voltage	V_{TM}	—	1.7	3.0	V	$I_T=300\text{ mA}$
On-State Current	I_{TM}	—	—	300	mA	$PF=1.0$, $V_{T(RMS)}=1.7\text{ V}$
Surge (Non-Repetitive) On-State Current	I_{TSM}	—	—	3.0	A	$f=50\text{ Hz}$
Holding Current	I_H	—	65	200	μA	$V_T=3.0\text{ V}$
Latching Current	I_L	—	5.0	—	mA	$V_T=2.2\text{ V}$
LED Trigger Current	I_{FT}	—	0.7	1.3	mA	$V_{AK}=5.0\text{ V}$
Turn-On Time	t_{ON}	—	35	—	μs	$V_{RM}=V_{DM}=424\text{ VAC}$
Turn-Off Time	t_{OFF}	—	50	—	μs	$PF=1.0$, $I_T=300\text{ mA}$
Critical State of Rise of Off-State Voltage	dv/dt_{cr}	10000	—	—	V/ μs	$V_D=0.67 V_{DRM}$, $T_j=25^\circ\text{C}$
		5000	—	—		$V_D=0.67 V_{DRM}$, $T_j=80^\circ\text{C}$
Critical Rate of Rise of Voltage at Current Commutation	dv/dt_{crq}	10000	—	—	V/ μs	$V_D=0.67 V_{DRM}$, $di/dt_{crq}\leq 15\text{ A/ms}$ $T_j=25^\circ\text{C}$
		5000	—	—		$V_D=0.67 V_{DRM}$, $di/dt_{crq}\leq 15\text{ A/ms}$ $T_j=80^\circ\text{C}$
Off-State Current	di/dt	—	100	—	A/ms	$I_T=300\text{ mA}$
Thermal Resistance, Junction to Lead	R_{THJL}	—	150	—	K/W	—
Package						
Critical Rate of Rise of Coupled Input-Output Voltage	$dv_{(IO)}/dt$	5000	—	—	V/ μs	$I_T=0\text{ A}$, $V_{RM}=V_{DM}=300\text{ VAC}$
Common Mode Coupling Capacitor	C_{CM}	—	0.01	—	pF	—
Package Capacitance	C_{IO}	—	0.8	—	pF	$f=1.0\text{ MHz}$, $V_{IO}=0\text{ V}$

Figure 1. LED forward current vs. forward voltage

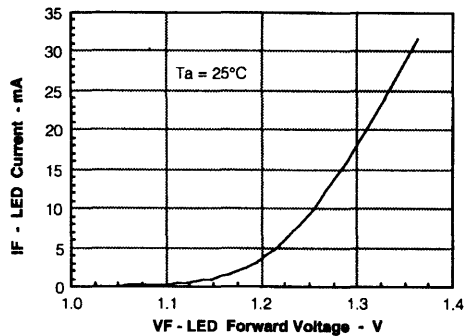

Figure 2. Forward voltage versus forward current

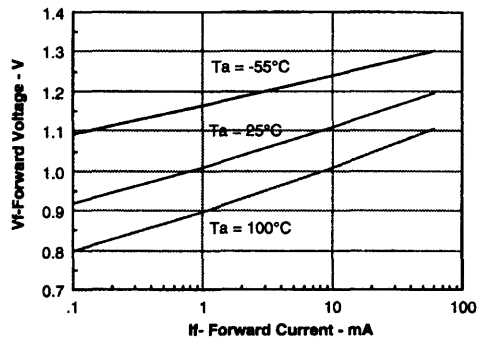

Figure 3. Peak LED current vs. duty factor, Tau

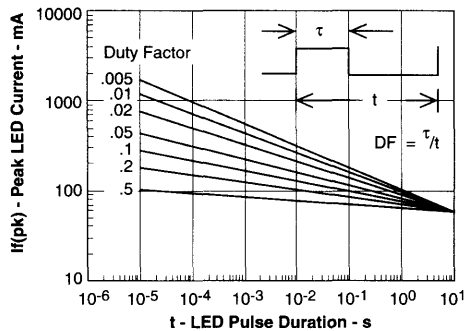

Figure 4. Maximum LED power dissipation

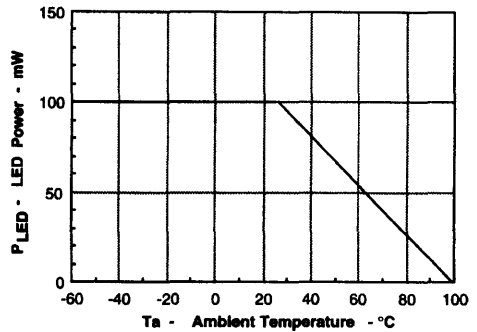

Figure 5. On-state terminal voltage vs. terminal current

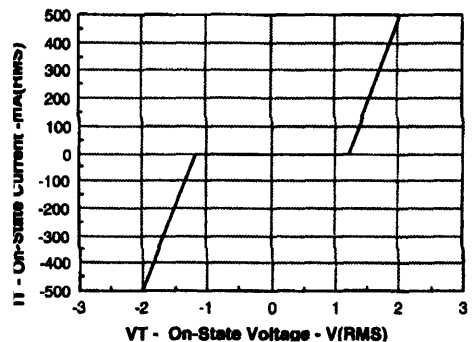
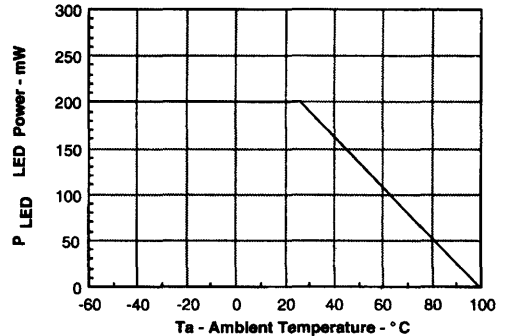

Figure 6. Maximum output power dissipation



Power Factor Considerations

A snubber isn't needed to eliminate false operation of the TRIAC driver because of the IL4111's high static and commutating dv/dt with loads between 1 and 0.8 power factors. When inductive loads with power factors less than 0.8 are being driven, include a RC snubber or a single capacitor directly across the device to damp the peak commutating dv/dt spike. Normally a commutating dv/dt causes a turning-off device to stay on due to the stored energy remaining in the turning-off device.

But in the case of a zero voltage crossing optotriac, the commutating dv/dt spikes can inhibit one half of the TRIAC from turning on. If the spike potential exceeds the inhibit voltage of the zero cross detection circuit, half of the TRIAC will be held-off and not turn-on. This hold-off condition can be eliminated by using a snubber or capacitor placed directly across the optotriac as shown in Figure 7. Note that the value of the capacitor increases as a function of the load current.

The hold-off condition also can be eliminated by providing a higher level of LED drive current. The higher LED drive provides a larger photocurrent which causes the phototransistor to turn-on before the commutating spike has activated the zero cross network. Figure 8 shows the relationship of the LED drive for power factors of less than 1.0. The curve shows that if a device requires 1.5 mA for a resistive load, then 1.8 times (2.7 mA) that amount would be required to control an inductive load whose power factor is less than 0.3.

Figure 7. Shunt capacitance versus load current versus power factor

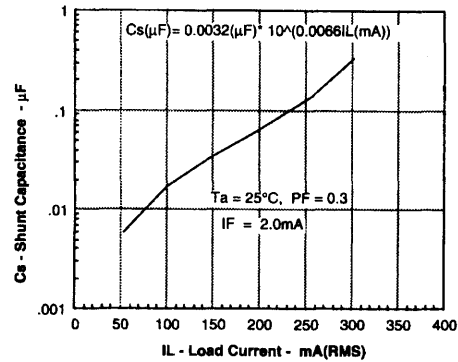

Figure 8. Normalized LED trigger current versus power factor

