



Raychem | CGS RC

TE Internal #: 276481-000

CGS RC, Hook Up Wire, MIL-DTL-22759, 600V Voltage Rating, Red Wire Color, 20AWG Wire Size, Operating Temperature Range -65 – 200 °C

[View on TE.com >](#)

Wire & Cable > Hook Up Wire



Cable Type: **MIL-DTL-22759**

Voltage Rating: **600 V**

Wire Color: **Red**

Insulation Material: **Modified Radiation Cross-linked ETFE Polymer**

Conductor Material: **Silver-Coated High Strength Copper Alloy**

## Features

### Product Type Features

Cable Type	MIL-DTL-22759
------------	---------------

### Electrical Characteristics

Voltage Rating	600 V
----------------	-------

### Body Features

Wire Color	Red
Insulation Material	Modified Radiation Cross-linked ETFE Polymer
Conductor Material	Silver-Coated High Strength Copper Alloy

### Dimensions

Wire Size	20 AWG
-----------	--------

### Usage Conditions

Operating Temperature Range	-65 – 200 °C
-----------------------------	--------------

## Product Compliance

[For compliance documentation, visit the product page on TE.com>](#)

EU RoHS Directive 2011/65/EU	Compliant
EU ELV Directive 2000/53/EC	Compliant



China RoHS 2 Directive MIIT Order No 32, 2016	No Restricted Materials Above Threshold
EU REACH Regulation (EC) No. 1907/2006	Current ECHA Candidate List: JUN 2020 (209) Candidate List Declared Against: JAN 2019 (197) Does not contain REACH SVHC
Halogen Content	Out of Scope - excluded from Halogen requirements
Solder Process Capability	Not applicable for solder process capability

Product Compliance Disclaimer

This information is provided based on reasonable inquiry of our suppliers and represents our current actual knowledge based on the information they provided. This information is subject to change. The part numbers that TE has identified as EU RoHS compliant have a maximum concentration of 0.1% by weight in homogenous materials for lead, hexavalent chromium, mercury, PBB, PBDE, DBP, BBP, DEHP, DIBP, and 0.01% for cadmium, or qualify for an exemption to these limits as defined in the Annexes of Directive 2011/65/EU (RoHS2). Finished electrical and electronic equipment products will be CE marked as required by Directive 2011/65/EU. Components may not be CE marked. Additionally, the part numbers that TE has identified as EU ELV compliant have a maximum concentration of 0.1% by weight in homogenous materials for lead, hexavalent chromium, and mercury, and 0.01% for cadmium, or qualify for an exemption to these limits as defined in the Annexes of Directive 2000/53/EC (ELV). Regarding the REACH Regulations, TE's information on SVHC in articles for this part number is still based on the European Chemical Agency (ECHA) 'Guidance on requirements for substances in articles' (Version: 2, April 2011), applying the 0.1% weight on weight concentration threshold at the finished product level. TE is aware of the European Court of Justice ruling of September 10th, 2015 also known as O5A (Once An Article Always An Article) stating that, in case of 'complex object', the threshold for a SVHC must be applied to both the product as a whole and simultaneously to each of the articles forming part of its composition. TE has evaluated this ruling based on the new ECHA "Guidance on requirements for substances in articles" (June 2017, version 4.0) and will be updating its statements accordingly.

### Compatible Parts

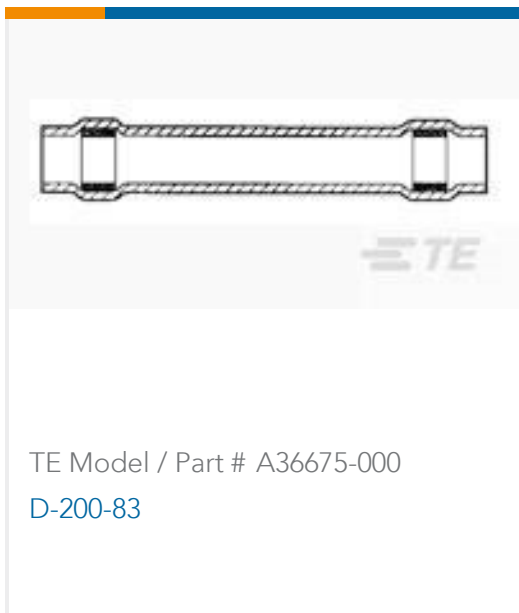

TE Model / Part # A36675-000  
D-200-83

### Also in the Series | CGS RC

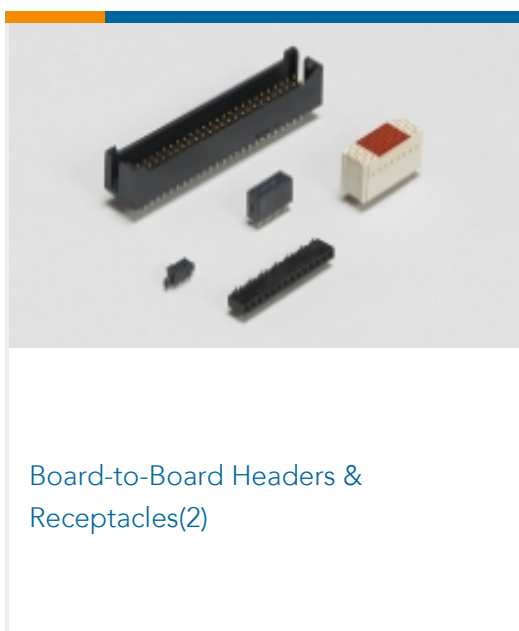

Board-to-Board Headers & Receptacles(2)

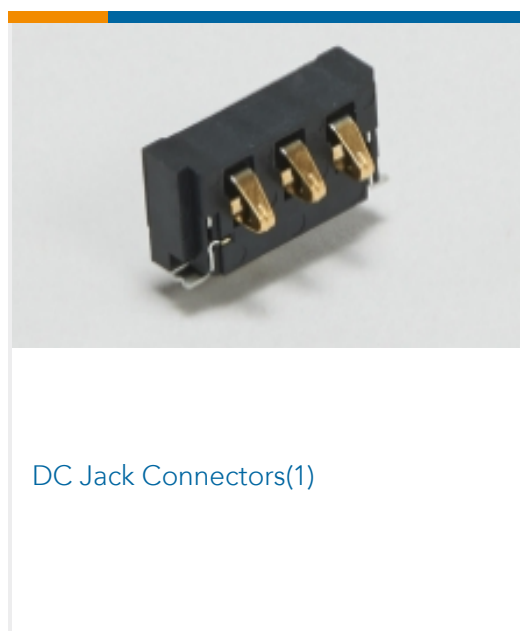

DC Jack Connectors(1)

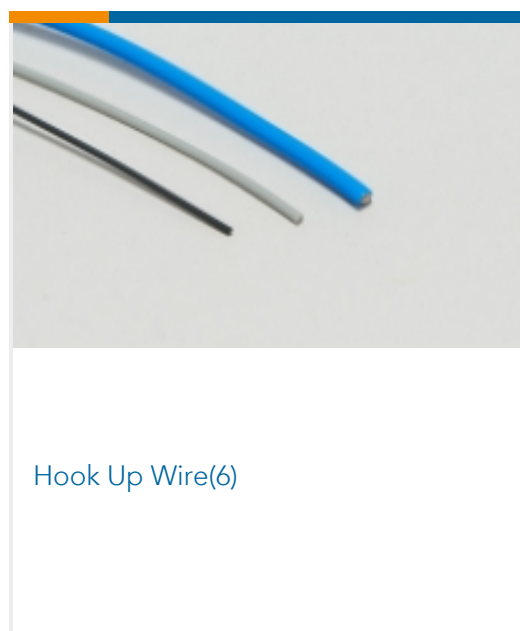

Hook Up Wire(6)



Probe Pads(4)



Rack & Panel Connectors(1)

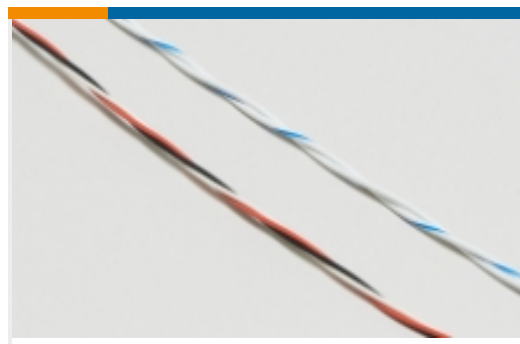

Twisted Pair Cable(5)

## Customers Also Bought

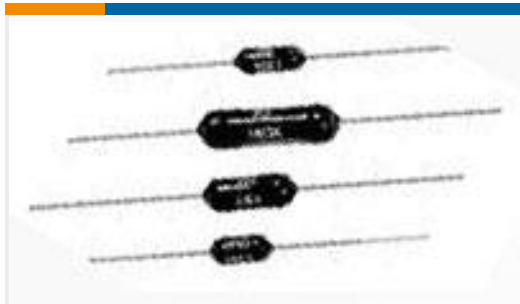

TE Model / Part #8-1879642-3  
H8 1K11 0.1% 5PPM



TE Model / Part #F733323001  
55D0111-22-9

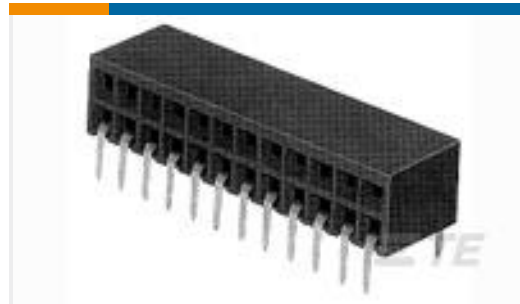

TE Model / Part #3-87962-1  
64 MODII HORZ DR CE 100CL/115

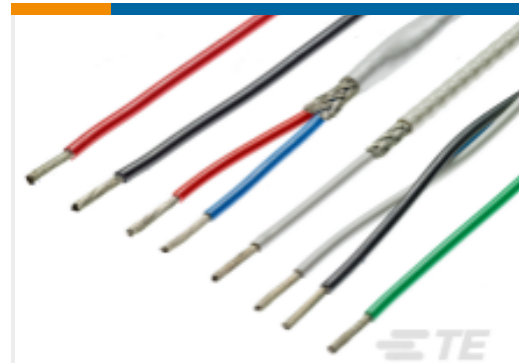

TE Model / Part #2823013001  
44A0211-8-9



TE Model / Part #3476303001  
55A0812-22-0



TE Model / Part #6-146459-4  
14 MODII HDR SRST UNSHRD STKG



TE Model / Part #1-1617138-0  
MAW-26S = RELAY



TE Model / Part #1614379-5  
RN 0805 12K 0.1% 10PPM CUT LENGTH



TE Model / Part #5-1676274-4  
RN 0805 27K 0.1% 10PPM 1K RL



TE Model / Part #1879281-1  
RP 2A 309K 0.1% 15PPM CUT LENGTH

## Documents

### Product Drawings

[22759/35-20-2](#)

English

### Datasheets & Catalog Pages

[1654025\\_Sec9\\_SPEC55](#)

English

[Raychem Wire and Cable Quick Reference Guide](#)

English



---

**Product Specifications**

Product Specification

English