

8-CHANNEL ELECTRONIC VOLUME WITH INPUT SELECTOR

GENERAL DESCRIPTION

NJW1157 is an eight channel electronic volume IC. It includes Input selector, tone control, volume, mute, input selector gain control, volume output gain control and 5 REC outputs. It's suitable for multi-channel audio equipments such as AV receivers and DVD receivers. These functions are controlled by three-wired serial data.

PACKAGE OUTLINE

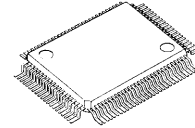

NJW1157FC2

FEATURES

- Operating Voltage
- Three-Wired Serial Data Control
- Input Selector (x 2)
- REC Output (x 5) with Selector
- Input Selector Gain Control
- Volume Output Gain Control
- Volume
- Tone Control
- Subwoofer output addition to L, R channel output
- Subwoofer output ON/OFF control
- Bi-CMOS Technology
- Package Outline

±4.5 to ±7.5V

Gain : 0/-3/-6/-9/-12dB
 Gain : 0/+3/+6/+9/+12/+15/+18dB
 0 to -100dB/1dBstep, MUTE
 0 to ±10dB/1dBstep

QFP100 – C2

BLOCK DIAGRAM

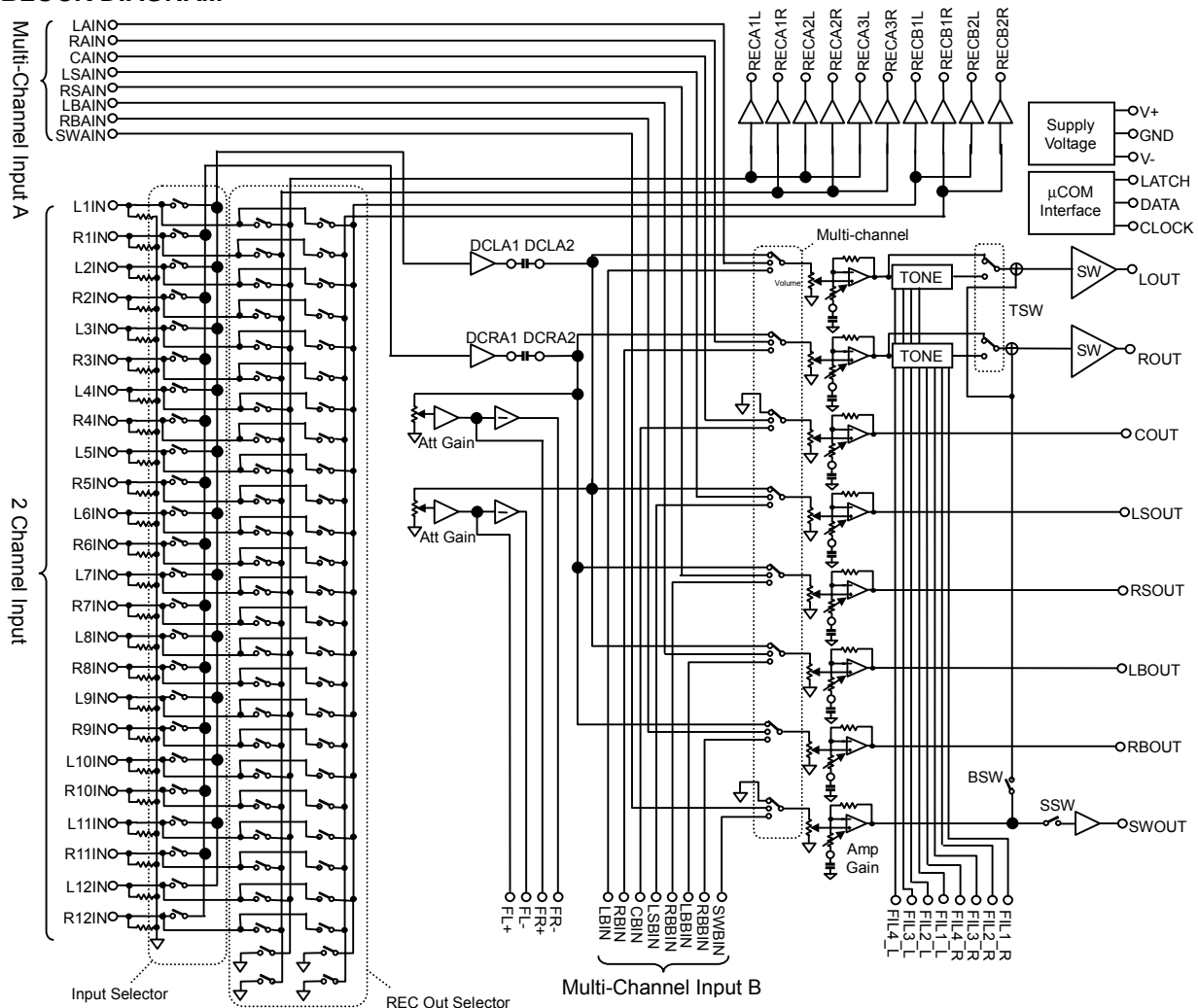

■ PIN FUNCTION

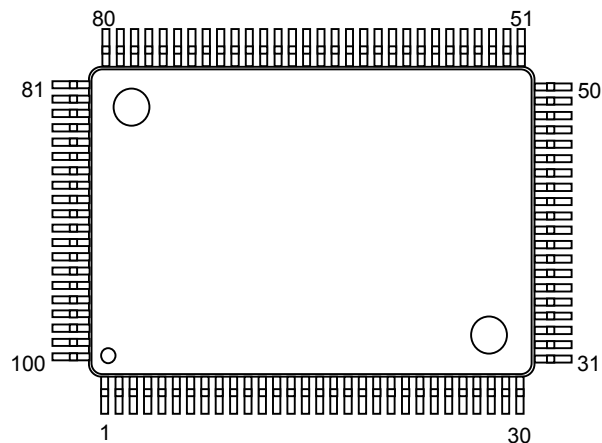

No.	SYMBOL	FUNCTION	No.	SYMBOL	FUNCTION
1	LOUT	Lch output	51	L11IN	"Input selector" Lch input 1
2	ROUT	Rch output	52	R11IN	"Input selector" Rch input 1
3	COUT	Cch output	53	L2IN	"Input selector" Lch input 2
4	LSOUT	LSch output	54	R2IN	"Input selector" Rch input 2
5	RSOUT	RSch output	55	L3IN	"Input selector" Lch input 3
6	LBOUT	LBch output	56	R3IN	"Input selector" Rch input 3
7	ROUT	RBch output	57	L4IN	"Input selector" Lch input 4
8	SWOUT	SWch output	58	R4IN	"Input selector" Rch input 4
9	DC_L1	Lch Bass filter DC cut capacitor output terminal	59	L5IN	"Input selector" Lch input 5
10	DC_L2	Lch Bass filter DC cut capacitor input terminal	60	R5IN	"Input selector" Rch input 5
11	FIL_BL	Lch Bass filter terminal	61	L6IN	"Input selector" Lch input 6
12	FIL_TL	Lch Treble filter terminal	62	R6IN	"Input selector" Rch input 6
13	DC_R1	Rch Bass filter DC cut capacitor output terminal	63	L7IN	"Input selector" Lch input 7
14	DC_R2	Rch Bass filter DC cut capacitor input terminal	64	R7IN	"Input selector" Rch input 7
15	FIL_BR	Rch Bass filter terminal	65	L8IN	"Input selector" Lch input 8
16	FIL_TR	Rch Treble filter terminal	66	R8IN	"Input selector" Rch input 8
17	N.C.	No Connect	67	L9IN	"Input selector" Lch input 9
18	N.C.	No Connect	68	R9IN	"Input selector" Rch input 9
19	V+	+ Power supply voltage input	69	L10IN	"Input selector" Lch input 10
20	V-	- Power supply voltage input	70	R10IN	"Input selector" Rch input 10
21	REC_A1L	"Input selector" Lch REC output A1	71	L11IN	"Input selector" Lch input 11
22	REC_A1R	"Input selector" Rch REC output A1	72	R11IN	"Input selector" Rch input 11
23	REC_A2L	"Input selector" Lch REC output A2	73	L12IN	"Input selector" Lch input 12
24	REC_A2R	"Input selector" Rch REC output A2	74	R12IN	"Input selector" Rch input 12
25	REC_A3L	"Input selector" Lch REC output A3	75	N.C.	No Connect
26	REC_A3R	"Input selector" Rch REC output A3	76	DGND	Digital Ground
27	REC_B1L	"Input selector" Lch REC output B1	77	DATA	Control data signal input
28	REC_B1R	"Input selector" Rch REC output B1	78	CLOCK	Clock signal input
29	REC_B2L	"Input selector" Lch REC output B2	79	LATCH	Latch signal input
30	REC_B2R	"Input selector" Rch REC output B2	80	LAIN	Multi-channel Lch input A
31	DCCAP_L	Switching noise rejection capacitor	81	RAIN	Multi-channel Rch input A
32	DCCAP_R	Switching noise rejection capacitor	82	CAIN	Multi-channel Cch input A
33	DCCAP_C	Switching noise rejection capacitor	83	LSAIN	Multi-channel LSch input A
34	GND	Ground	84	RSAIN	Multi-channel RSch input A
35	GND	Ground	85	LBAIN	Multi-channel LBch input A
36	DCCAP_LS	Switching noise rejection capacitor	86	RBAIN	Multi-channel RBch input A
37	DCCAP_RS	Switching noise rejection capacitor	87	SWAIN	Multi-channel SWch input A
38	DCCAP_LB	Switching noise rejection capacitor	88	LBIN	Multi-channel Lch input B
39	DCCAP_RB	Switching noise rejection capacitor	89	RBIN	Multi-channel Rch input B
40	DCCAP_SW	Switching noise rejection capacitor	90	CBIN	Multi-channel Cch input B
41	DCL_OUT	"Input selector" Lch output	91	LSBIN	Multi-channel LSch input B
42	DCL_IN	"Multi-channel selector" Lch input	92	RSBIN	Multi-channel RSch input B
43	DCR_OUT	"Input selector" Rch output	93	LBBIN	Multi-channel LBch input B
44	DCR_IN	"Multi-channel selector" Rch input	94	RBBIN	Multi-channel RBch input B
45	FL+	"Input selector gain control" Lch no-inverted output	95	SWBIN	Multi-channel SWch input B
46	FL-	"Input selector gain control" Lch inverted output	96	GND	Ground
47	FR+	"Input selector gain control" Rch no-inverted output	97	GND	Ground
48	FR-	"Input selector gain control" Rch inverted output	98	VSSOUT2	Internal Digital -Power Supply Output 2
49	VDDOUT	Internal Digital +Power Supply Output	99	VDDOUT2	Internal Digital +Power Supply Output 2
50	VSSOUT	Internal Digital -Power Supply Output	100	TCCAP	Switching noise rejection capacitor

■ ABSOLUTE MAXIMUM RATING (Ta=25°C)

PARAMETER	SYMBOL	RATING	UNIT
Power Supply Voltage	V ₊ /V ₋	+7.5/-7.5	V
Maximum Input Voltage	V _{IM}	V ₊ /V ₋	V
Power Dissipation	P _D	1300 (* On board)	mW
Operating Temperature Range	Topr	-40 to +85	°C
Storage Temperature Range	Tstg	-40 to +125	°C

■ ELECTRICAL CHARACTERISTICS (Ta=25°C, V₊/V₋=±7V)

PARAMETER	SYMBOL	TEST CONDITION	MIN.	TYP.	MAX.	UNIT
-----------	--------	----------------	------	------	------	------

◆ Power Supply

Operating Voltage 1	V ₊	-	4.5	7.0	7.5	V
Operating Voltage 2	V ₋	-	-7.5	-7.0	-4.5	V
Supply Current 1	I _{CC}	No signal (V ₊)	-	25	43	mA
Supply Current 2	I _{EE}	No signal (V ₋)	-	25	43	mA

◆ Input/Output Characteristics (Output : 1 to 8pin)

Maximum Output Voltage	V _{OM}	f=1kHz, THD=1% Volume=0dB	3.0	4.0	-	V _{rms}
Voltage Gain	G _V	V _{IN} =1V _{rms} , f=1kHz Volume=0dB	-0.5	0	0.5	dB
Voltage Gain Error	ΔG _V	V _{IN} =1V _{rms} , f=1kHz Volume=0dB	-0.5	0	0.5	dB
Maximum Attenuation	A _{TT}	f=1kHz, V _{IN} =1V _{rms} Volume=Mute	-	-110	-	dB
Attenuation Error	ΔA _{TT}	f=1kHz, V _{IN} =1V _{rms} Volume=-60dB	-1	0	1	dB
Output Noise	V _{NO}	Volume=0dB, R _g =0, A-weight	-	-110 (3.2μ)	-100 (10μ)	dBV (V _{rms})
Total Harmonic Distortion	T.H.D.	f=1kHz, V _o =1V _{rms} , Volume=0dB	-	0.005	0.05	%
Channel Separation	CS	f=1kHz, V _o =1V _{rms} , A-weight Volume=0dB	-	-100	-90	dB

◆ Input/Output Characteristics (REC output : 21 to 30pin)

REC Out Voltage Gain	G _{VREC}	V _{IN} =1V _{rms} , f=1kHz	-0.5	0	0.5	dB
REC Out Total Harmonic Distortion	T.H.D. _{REC}	f=1kHz, V _o =1V _{rms} ,	-	0.005	0.05	%

◆ Input Selector Gain Control Characteristics

Input Selector Gain Control Voltage Gain 1	G _{VINC1}	Input Selector Gain = 0dB	-0.5	0	+0.5	dB
Input Selector Gain Control Voltage Gain 2	G _{VINC2}	Input Selector Gain = -6dB	-6.5	-6.0	-5.5	dB
Input Selector Gain Control Voltage Gain 3	G _{VINC3}	Input Selector Gain = -12dB	-12.5	-12.0	-11.5	dB

■ ELECTRICAL CHARACTERISTICS (Ta=25°C, V⁺/V⁻=±7V)

PARAMETER	SYMBOL	TEST CONDITION	MIN.	TYP.	MAX.	UNIT
◆Tone Control Characteristics						
Treble Voltage Gain 1	G _{VTREB1}	Vo=1Vrms, f=10kHz Volume=0dB Treble=0dB	-2.0	0	2.0	dB
Treble Voltage Gain 2	G _{VTREB2}	Vo=1Vrms, f=10kHz Volume=0dB Treble=10dB	8.0	10.0	12.0	dB
Treble Voltage Gain 3	G _{VTREB3}	Vo=1Vrms, f=10kHz Volume=0dB Treble=-10dB	-12.0	-10.0	-8.0	dB
Bass Voltage Gain 1	G _{VBASS1}	Vo=1Vrms, f=100Hz Volume=0dB Bass=0dB	-2.0	0	2.0	dB
Bass Voltage Gain 2	G _{VBASS2}	Vo=1Vrms, f=100Hz Volume=0dB Bass=10dB	8.0	10.0	12.0	dB
Bass Voltage Gain 3	G _{VBASS3}	Vo=1Vrms, f=100Hz Volume=0dB Bass=-10dB	-12.0	-10.0	-8.0	dB
◆Volume Output Gain Control Characteristics						
Volume Output Gain Control Voltage Gain 1	G _{VOUTC1}	Volume=0dB Volume Output Gain=3dB	2.0	3.0	4.0	dB
Volume Output Gain Control Voltage Gain 2	G _{VOUTC2}	Volume =0dB Volume Output Gain =9dB	8.0	9.0	10.0	dB
Volume Output Gain Control Voltage Gain 3	G _{VOUTC3}	Volume =0dB Volume Output Gain =18dB	17.0	18.0	19.0	dB
◆Logic Control Characteristics						
High Level Input Voltage	V _{IH}	-	2.5	-	5.5	V
Low Level Input Voltage	V _{IL}	-	0	-	1.5	V

■ TERMINAL DESCRIPTION

PIN NO.	SYMBOL	FUNCTION	EQUIVALENT CIRCUIT	TERMINAL DC VOLTAGE
1 2	LOUT ROUT	Lch Output Rch Output		0
3 4 5 6 7 8	COUT LSOUT RSOUT LBOUT RBOUT SWOUT	Cch Output LSch Output RSch Output LBch Output RBch Output SWch Output		0
9 13	DC_L1 DC_R1	Lch Bass filter DC cut capacitor output terminal Rch Bass filter DC cut capacitor output terminal		0
10 14	DC_L2 DC_R2	Lch Bass filter DC cut capacitor input terminal Rch Bass filter DC cut capacitor input terminal		0

■ TERMINAL DESCRIPTION

PIN NO.	SYMBOL	FUNCTION	EQUIVALENT CIRCUIT	TERMINAL DC VOLTAGE
11 15	FIL_BL FIL_BR	Lch Bass filter terminal Rch Bass filter terminal		0
12 16	FIL_TL FIL_TR	Lch Treble filter terminal Rch Treble filter terminal		0
19	V+	+Power Supply Voltage Input		V+
21 22 23 24 25 26 27 28 29 30 41 43 45 47	REC_A1L REC_A1R REC_A2L REC_A2R REC_A3L REC_A3R REC_B1L REC_B1R REC_B2L REC_B2R DCL_OUT DCR_OUT FL+ FR+	"Input selector" Lch REC output A1 "Input selector" Rch REC output A1 "Input selector" Lch REC output A2 "Input selector" Rch REC output A2 "Input selector" Lch REC output A3 "Input selector" Rch REC output A3 "Input selector" Lch REC output B1 "Input selector" Rch REC output B1 "Input selector" Lch REC output B2 "Input selector" Rch REC output B2 "Input selector" Lch output "Input selector" Rch output "Input selector gain control" Lch no-inverted output "Input selector gain control" Rch no-inverted output		0

■ TERMINAL DESCRIPTION

PIN NO.	SYMBOL	FUNCTION	EQUIVALENT CIRCUIT	TERMINAL DC VOLTAGE
31 32 33 36 37 38 39 40	DCCAP_L DCCAP_R DCCAP_C DCCAP_LS DCCAP_RS DCCAP_LB DCCAP_RB DCCAP_SW	Switching noise rejection capacitor Switching noise rejection capacitor Switching noise rejection capacitor Switching noise rejection capacitor Switching noise rejection capacitor Switching noise rejection capacitor Switching noise rejection capacitor Switching noise rejection capacitor		0
34 35 76 96 97	GND GND DGND GND GND	Ground Ground Digital Ground Ground Ground		0
42 44 51 52 53 54 55 56 57 58 59 60 61 62 63 64 65 66 67 68 69 70 71 72 73 74	DCL_IN DCR_IN L1_IN R1_IN L2_IN R2_IN L3_IN R3_IN L4_IN R4_IN L5_IN R5_IN L6_IN R6_IN L7_IN R7_IN L8_IN R8_IN L9_IN R9_IN L10_IN R10_IN L11_IN R11_IN L12_IN R12_IN	"Multi-channel selector" Lch input "Multi-channel selector" Rch input "Input selector" Lch input 1 "Input selector" Rch input 1 "Input selector" Lch input 2 "Input selector" Rch input 2 "Input selector" Lch input 3 "Input selector" Rch input 3 "Input selector" Lch input 4 "Input selector" Rch input 4 "Input selector" Lch input 5 "Input selector" Rch input 5 "Input selector" Lch input 6 "Input selector" Rch input 6 "Input selector" Lch input 7 "Input selector" Rch input 7 "Input selector" Lch input 8 "Input selector" Rch input 8 "Input selector" Lch input 9 "Input selector" Rch input 9 "Input selector" Lch input 10 "Input selector" Rch input 10 "Input selector" Lch input 11 "Input selector" Rch input 11 "Input selector" Lch input 12 "Input selector" Rch input 12		0

■ TERMINAL DESCRIPTION

PIN NO.	SYMBOL	FUNCTION	EQUIVALENT CIRCUIT	TERMINAL DC VOLTAGE
46 48	FL- FR-	"Input selector gain control" Lch inverted output "Input selector gain control" Rch inverted output		0
49 50 98 99	VDD VSS VSS2 VDD2	Internal Digital +Power Supply Output Internal Digital -Power Supply Output Internal Digital -Power Supply Output2 Internal Digital +Power Supply Output2		VDD=VDD2 =+2.5V VSS=VSS2 =-2.5V
77 78 79	DATA CLOCK LATCH	Control data signal input Clock signal input Latch signal input		0
80 81 82 83 84 85 86 87 88 89 90 91 92 93 94 95	LAIN RAIN CAIN LSAIN RSAIN LBAIN RBAIN SWAIN LBIN RBIN CBIN LSBIN RSBIN LBBIN RBBIN SWBIN	Multi-channel Lch input A Multi-channel Rch input A Multi-channel Cch input A Multi-channel LSch input A Multi-channel RSch input A Multi-channel LBch input A Multi-channel RBch input A Multi-channel SWch input A Multi-channel Lch input B Multi-channel Rch input B Multi-channel Cch input B Multi-channel LSch input B Multi-channel RSch input B Multi-channel LBch input B Multi-channel RBch input B Multi-channel SWch input B		0

APPLICATION CIRCUIT

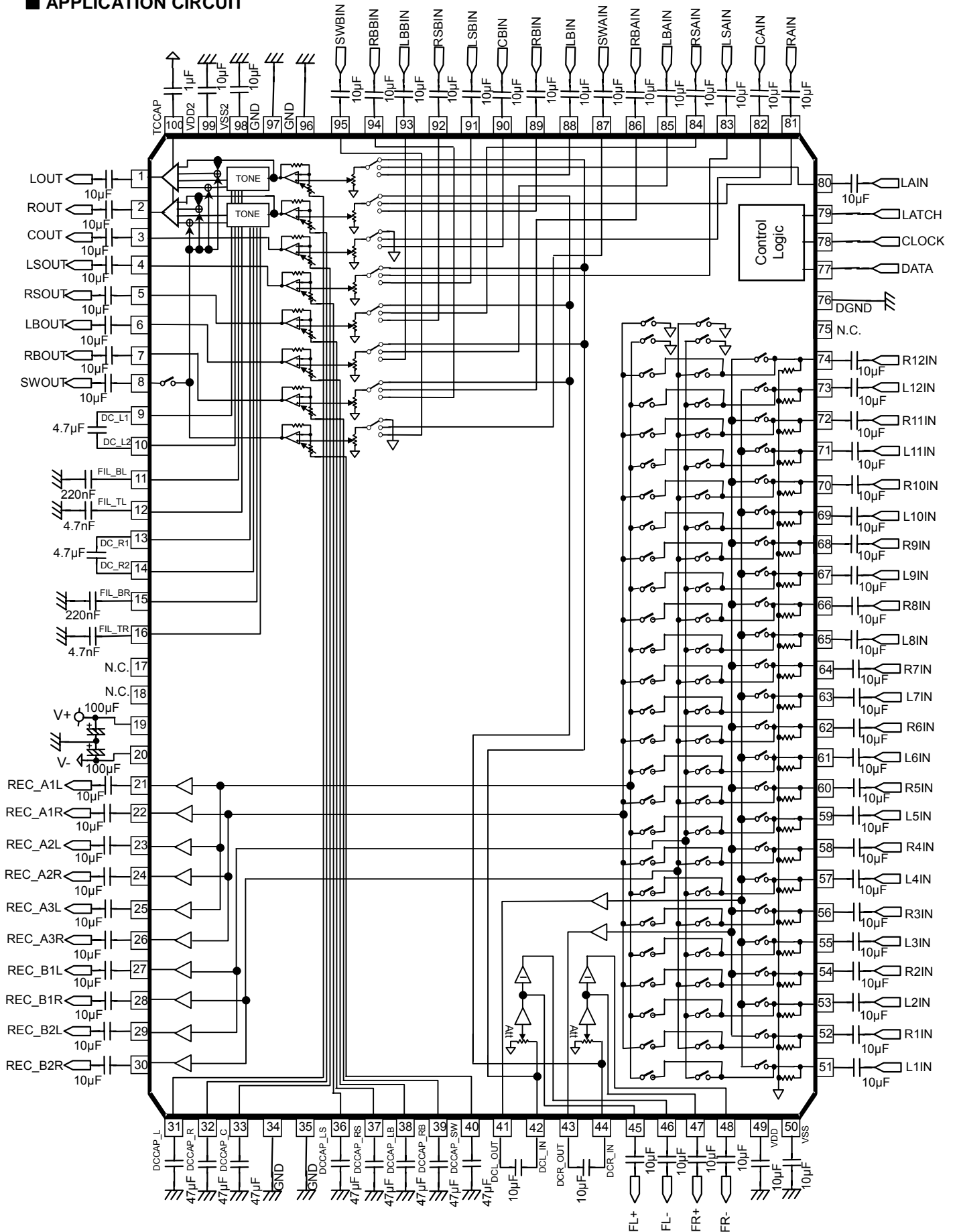

■ CONTROL DATA FORMAT

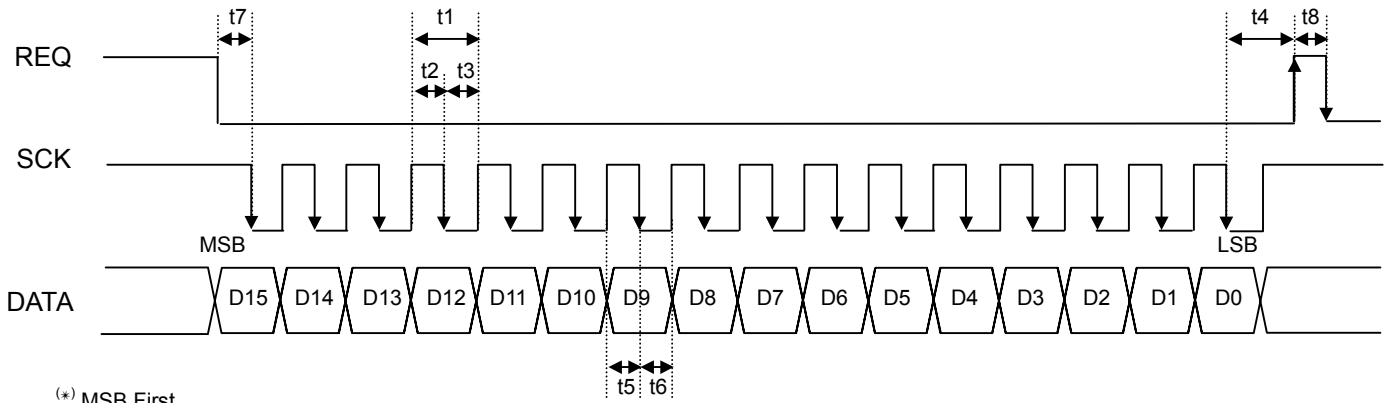

SYMBOL	PARAMETER	MIN	TYP	MAX	UNIT
t1	SCK Clock Width	2	-	-	μs
t2	SCK Pulse Width (High)	0.8	-	-	μs
t3	SCK Pulse Width (Low)	0.8	-	-	μs
t4	REQ Rise Hold Time	1.6	-	-	μs
t5	DATA Setup Time	0.8	-	-	μs
t6	DATA Hold Time	0.8	-	-	μs
t7	SCK Setup Time	0.8	-	-	μs
t8	REQ High Pulse Width	1.6	-	-	μs

■ CONTROL DATA

NJW1157 is controlled by 16-bits serial data.

MSB

LSB

D15	D14	D13	D12	D11	D10	D9	D8	D7	D6	D5	D4	D3	D2	D1	D0
Data								Select Address				Chip Address			

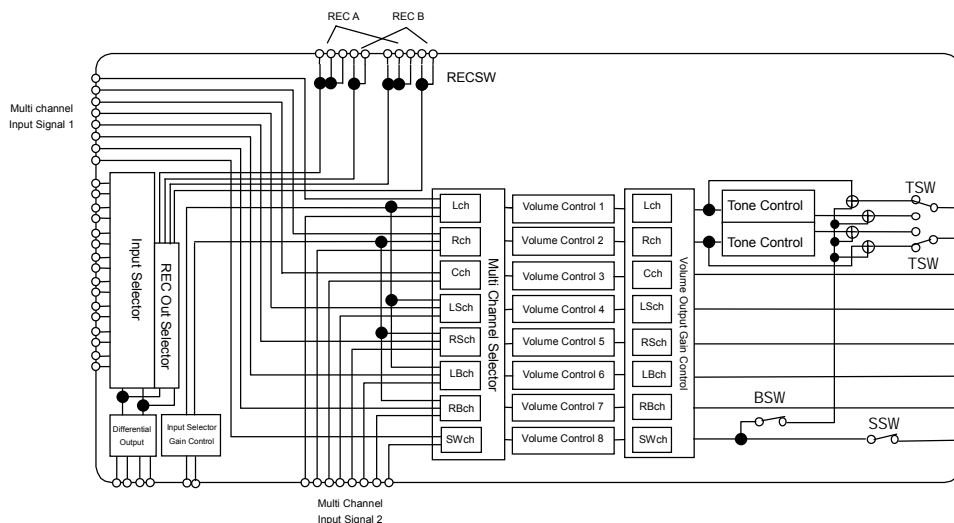

MSB

LSB

D15	D14	D13	D12	D11	D10	D9	D8	D7	D6	D5	D4	D3	D2	D1	D0
Volume Control 1							Don't Care	0	0	0	0	0	1	0	1
Volume Control 2							Don't Care	0	0	0	1	0	1	0	1
Volume Control 3							Don't Care	0	0	1	0	0	1	0	1
Volume Control 4							Don't Care	0	0	1	1	0	1	0	1
Volume Control 5							Don't Care	0	1	0	0	0	1	0	1
Volume Control 6							Don't Care	0	1	0	1	0	1	0	1
Volume Control 7							Don't Care	0	1	1	0	0	1	0	1
Volume Control 8							Don't Care	0	1	1	1	0	1	0	1
Input Selector Gain Control			Volume Output Gain Control			BSW	SSW	1	0	0	0	0	1	0	1
TC/B	Tone Control Treble				TSW	Don't Care	Don't Care	1	0	0	1	0	1	0	1
BC/B	Tone Control Bass				Don't Care	Don't Care	Don't Care	1	0	1	0	0	1	0	1
Input Selector				Multi Channel Selector		Don't Care		1	0	1	1	0	1	0	1
REC B Selector				REC A Selector				1	1	0	0	0	1	0	1

■ INITIAL CONDITION

MSB															LSB
D15	D14	D13	D12	D11	D10	D9	D8	D7	D6	D5	D4	D3	D2	D1	D0
1	1	1	1	1	1	1	1	0	0	0	0	0	1	0	1
1	1	1	1	1	1	1	1	0	0	0	1	0	1	0	1
1	1	1	1	1	1	1	1	0	0	1	0	0	1	0	1
1	1	1	1	1	1	1	1	0	0	1	1	0	1	0	1
1	1	1	1	1	1	1	1	0	1	0	0	0	1	0	1
1	1	1	1	1	1	1	1	0	1	0	1	0	1	0	1
1	1	1	1	1	1	1	1	0	1	1	0	0	1	0	1
1	1	1	1	1	1	1	1	0	1	1	1	0	1	0	1
0	0	0	0	0	0	0	0	1	0	0	0	0	1	0	1
0	0	0	0	0	0	0	0	1	0	0	1	0	1	0	1
0	0	0	0	0	0	0	0	1	0	1	0	0	1	0	1
0	0	0	0	0	0	0	0	1	0	1	1	0	1	0	1
0	0	0	0	0	0	0	0	1	1	0	0	0	1	0	1

■ DEFINITION OF RESISTOR

◆Volume Control 1 – 8 : 0dB to -100dB in 1dB/step.

D15	D14	D13	D12	D11	D10	D9	D8	D7	D6	D5	D4	D3	D2	D1	D0
Volume Control 1							Don't Care	0	0	0	0	0	1	0	1
Volume Control 2							Don't Care	0	0	0	1	0	1	0	1
Volume Control 3							Don't Care	0	0	1	0	0	1	0	1
Volume Control 4							Don't Care	0	0	1	1	0	1	0	1
Volume Control 5							Don't Care	0	1	0	0	0	1	0	1
Volume Control 6							Don't Care	0	1	0	1	0	1	0	1
Volume Control 7							Don't Care	0	1	1	0	0	1	0	1
Volume Control 8							Don't Care	0	1	1	1	0	1	0	1

< Volume Control 1 – 8 Data >

Data							Setting
D15	D14	D13	D12	D11	D10	D9	
0	0	0	0	0	0	0	0dB
0	0	0	0	0	0	1	-1dB
0	0	0	0	0	1	0	-2dB
0	0	0	0	0	1	1	-3dB
0	0	0	0	1	0	0	-4dB
0	0	0	0	1	0	1	-5dB
0	0	0	0	1	1	0	-6dB
0	0	0	0	1	1	1	-7dB
0	0	0	1	0	0	0	-8dB
0	0	0	1	0	0	1	-9dB
0	0	0	1	0	1	0	-10dB
0	0	0	1	0	1	1	-11dB
0	0	0	1	1	0	0	-12dB
0	0	0	1	1	0	1	-13dB
0	0	0	1	1	1	0	-14dB
...							...
1	1	0	0	0	0	1	-97dB
1	1	0	0	0	1	0	-98dB
1	1	0	0	0	1	1	-99dB
1	1	0	0	1	0	0	-100dB
1	1	1	1	1	1	1	MUTE ^(*)

^(*)Initial Setting

- ◆ **Input Selector Gain Control** : Gain control for selected signal at the Input Selector
- Volume Output Gain Control** : Gain control for volume output
- BSW** : SW ch Output add to L/R ch Output
- SSW** : SW ch Output ON/OFF

D15	D14	D13	D12	D11	D10	D9	D8	D7	D6	D5	D4	D3	D2	D1	D0
Input Selector Gain Control			Volume Output Gain Control			BSW	SSW	1	0	0	0	0	1	0	1

< Input Selector Gain Control Data >

Data			Setting
D15	D14	D13	
0	0	0	0dB ^(*)
0	0	1	-3dB
0	1	0	-6dB
0	1	1	-9dB
1	0	0	-12dB

< Volume Output Gain Control Data >

Data			Setting
D12	D11	D10	
0	0	0	0dB ^(*)
0	0	1	+3dB
0	1	0	+6dB
0	1	1	+9dB
1	0	0	+12dB
1	0	1	+15dB
1	1	0	+18dB

< BSW : SW ch Output add to L/R ch Output >

D9	Setting
0	OFF ^(*)
1	Add

< SSW : SW ch Output ON/OFF >

D8	Setting
0	SW Output ON ^(*)
1	SW Output OFF

^(*)Initial Setting

- ◆TC/B : Treble Cut / Boost
- Tone Control Treble : Treble Gain
- TSW : Tone Control By-pass Switch

D15	D14	D13	D12	D11	D10	D9	D8	D7	D6	D5	D4	D3	D2	D1	D0
TC/B	Tone Control Treble				TSW	Don't Care		1	0	0	1	0	1	0	1

< TC/B : Treble Cut / Boost >

D15	Setting
0	Cut ^(*)
1	Boost

< Tone Control Treble : Treble Gain >

Data				Cut	Boost
D14	D13	D12	D11		
0	0	0	0	0dB ^(*)	0dB
0	0	0	1	-1dB	1dB
0	0	1	0	-2dB	2dB
0	0	1	1	-3dB	3dB
0	1	0	0	-4dB	4dB
0	1	0	1	-5dB	5dB
0	1	1	0	-6dB	6dB
0	1	1	1	-7dB	7dB
1	0	0	0	-8dB	8dB
1	0	0	1	-9dB	9dB
1	0	1	0	-10dB	10dB

< Tone Control By-pass Switch >

D8	Setting
0	Tone Control OFF ^(*)
1	Tone Control ON

^(*)Initial Setting

- ◆BC/B : Bass Cut / Boost
- Tone Control Bass : Bass Gain

D15	D14	D13	D12	D11	D10	D9	D8	D7	D6	D5	D4	D3	D2	D1	D0
BC/B	Tone Control Bass				Don't Care			1	0	1	0	0	1	0	1

< BC/B : Bass Cut / Boost >

D15	Setting
0	Cut ^(*)
1	Boost

<Tone Control Bass : Bass Gain >

Data				Cut	Boost
D14	D13	D12	D11		
0	0	0	0	0dB ^(*)	0dB
0	0	0	1	-1dB	1dB
0	0	1	0	-2dB	2dB
0	0	1	1	-3dB	3dB
0	1	0	0	-4dB	4dB
0	1	0	1	-5dB	5dB
0	1	1	0	-6dB	6dB
0	1	1	1	-7dB	7dB
1	0	0	0	-8dB	8dB
1	0	0	1	-9dB	9dB
1	0	1	0	-10dB	10dB

^(*)Initial Setting

- ◆**Input Selector** : Selector for the stereo inputs from 1IN to 12IN
Multi Channel Selector : Selector for the 2ch Input signal, or multi channel input signal A, or multi channel input signal B

D15	D14	D13	D12	D11	D10	D9	D8	D7	D6	D5	D4	D3	D2	D1	D0
Input Selector				Multi Channel Selector		Don't Care		1	0	1	1	0	1	0	1

< Input Selector >

Data				Setting
D15	D14	D13	D12	
0	0	0	0	1IN (2ch Input 1) ^(*)
0	0	0	1	2IN (2ch Input 2)
0	0	1	0	3IN (2ch Input 3)
0	0	1	1	4IN (2ch Input 4)
0	1	0	0	5IN (2ch Input 5)
0	1	0	1	6IN (2ch Input 6)
0	1	1	0	7IN (2ch Input 7)
0	1	1	1	8IN (2ch Input 8)
1	0	0	0	9IN (2ch Input 9)
1	0	0	1	10IN (2ch Input 10)
1	0	1	0	11IN (2ch Input 11)
1	0	1	1	12IN (2ch Input 12)

< Multi Channel Selector >

Data		Setting
D11	D10	
0	0	Input Selector Output Signal ^(*)
0	1	Multi channel Input Signal A
1	0	Multi channel Input Signal B

In "Input Selector Output Signal" setting, the LSch, LBch and RSch, RBch output the signal same as the Lch and Rch, and the Cch and SWch output are set mute condition.

- ◆**REC A/B Selector** : Selector for the 2 ch Input signal to REC A/B output

D15	D14	D13	D12	D11	D10	D9	D8	D7	D6	D5	D4	D3	D2	D1	D0
REC B Selector				REC A Selector				1	1	0	0	0	1	0	1

< REC A/B Selector >

Data				Setting
D15	D14	D13	D12	
				REC B Selector
				REC A Selector
0	0	0	0	1IN (2ch Input 1) ^(*)
0	0	0	1	2IN (2ch Input 2)
0	0	1	0	3IN (2ch Input 3)
0	0	1	1	4IN (2ch Input 4)
0	1	0	0	5IN (2ch Input 5)
0	1	0	1	6IN (2ch Input 6)
0	1	1	0	7IN (2ch Input 7)
0	1	1	1	8IN (2ch Input 8)
1	0	0	0	9IN (2ch Input 9)
1	0	0	1	10IN (2ch Input 10)
1	0	1	0	11IN (2ch Input 11)
1	0	1	1	12IN (2ch Input 12)
1	1	0	0	Mute

^(*)Initial Setting

TYPICAL CHARACTERISTICS

Operating Current vs. Power Supply Voltage
Ta=25°C

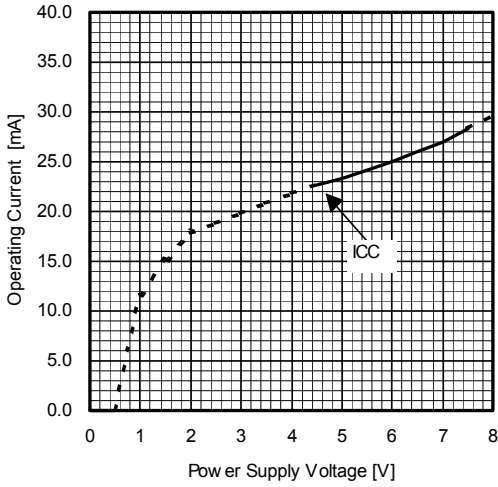

Operating Current vs. Power Supply Voltage
Ta=25°C

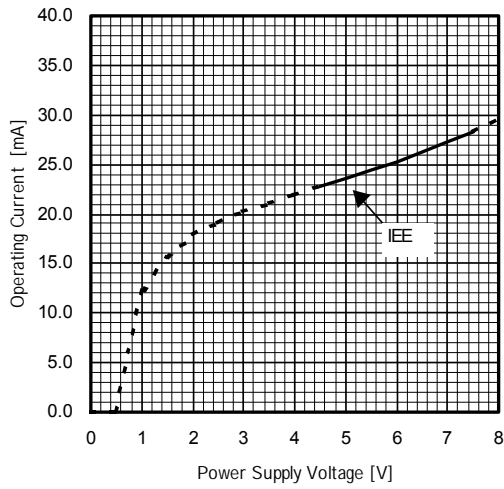

Voltage Gain vs. Attenuator Set Level
V+=7V V-=-7V Vin=0dBV f=1kHz RL=10kΩ Ta=25°C

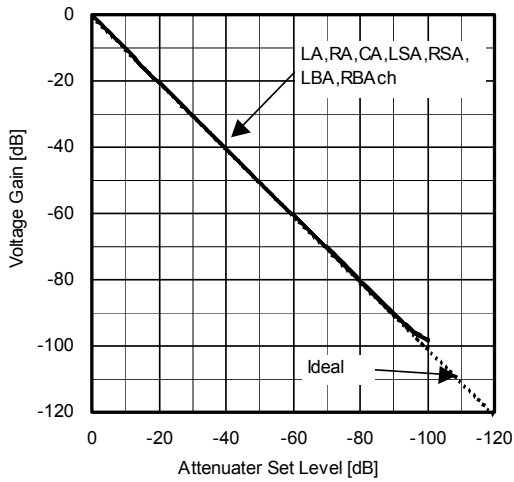

Voltage Gain vs. Output Gain Set Level
V+=7V V-=-7V Vin=0dBV f=1kHz RL=10kΩ Ta=25°C

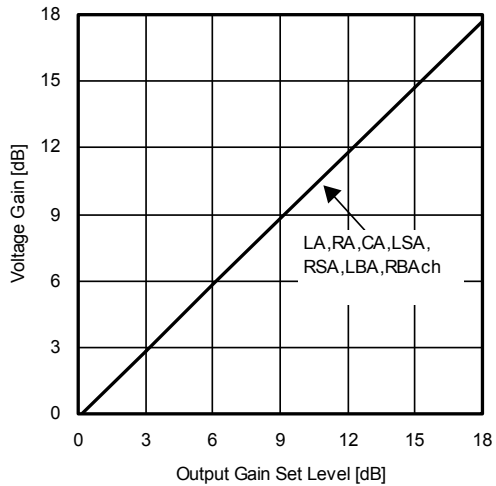

Input Selector Output Gain vs. Gain Set Level
V+=7V V-=-7V Vin=0dBV f=1kHz RL=10kΩ Ta=25°C

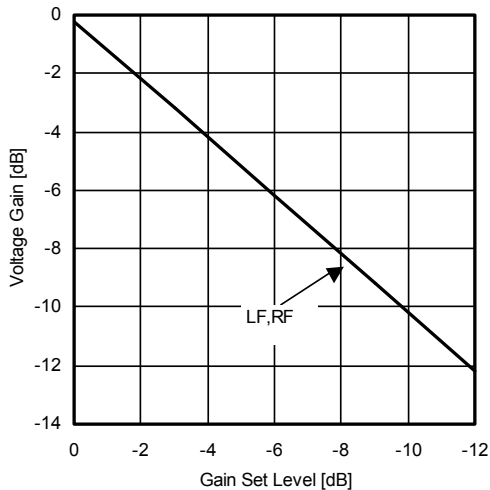

Tone Control Output Level vs. Frequency
V+=7V V-=-7V Vin=0dBV RL=10kΩ, LAch. Ta=25°C

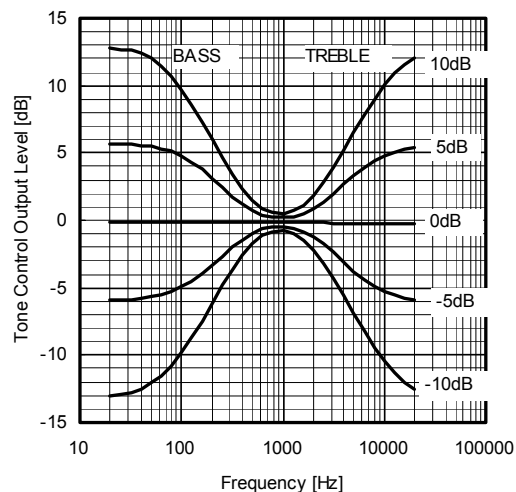

TYPICAL CHARACTERISTICS

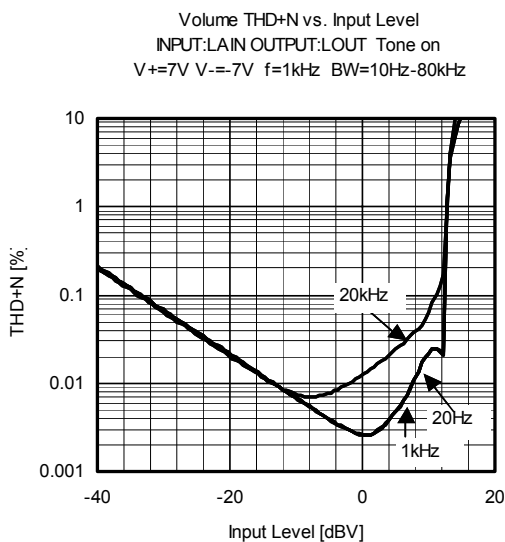
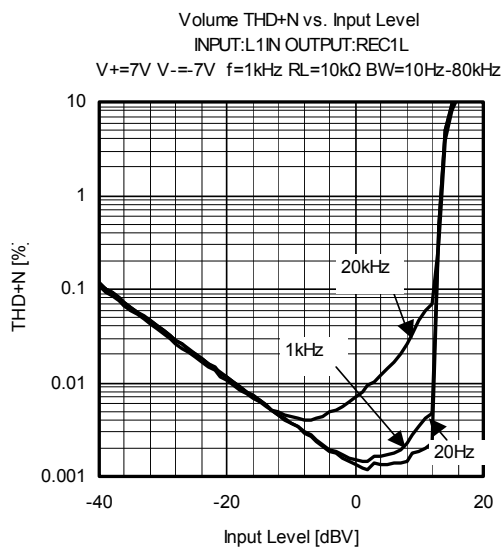
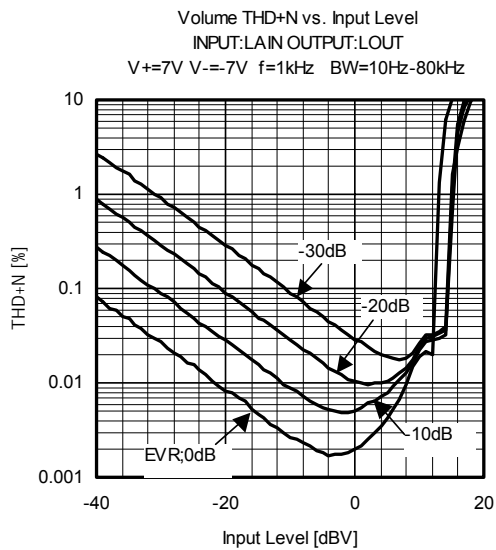
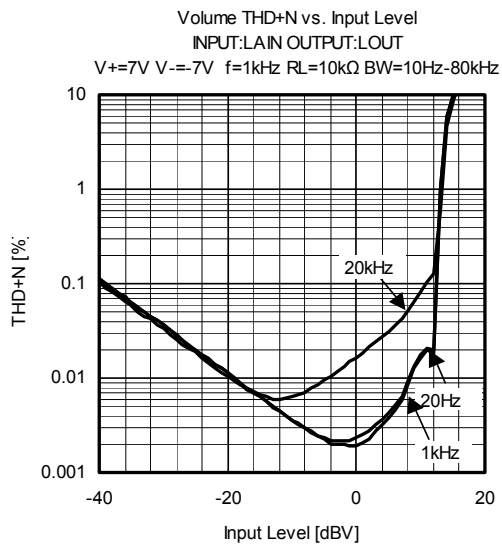

TYPICAL CHARACTERISTICS

Operating Current vs. Ambient Temperature
ICC V+=7V V=-7V

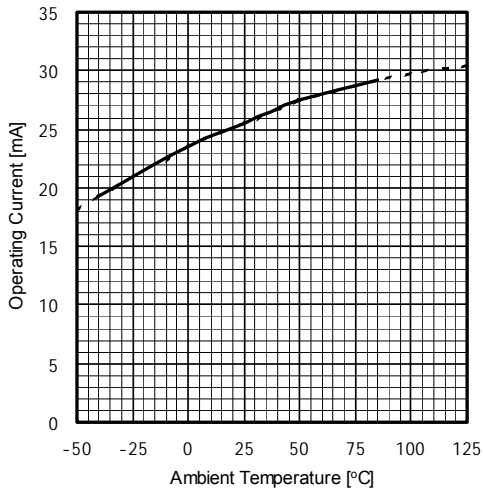

Operating Current vs. Ambient Temperature
IEE V+=7V V=-7V

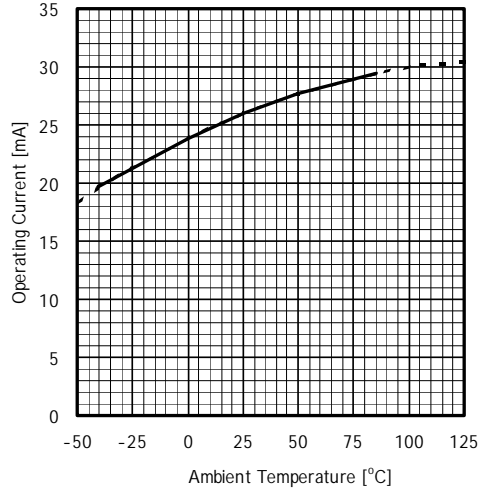

Voltage Gain vs. Ambient Temperature
V+=7V V=-7V
Vin=1Vrms f=1kHz

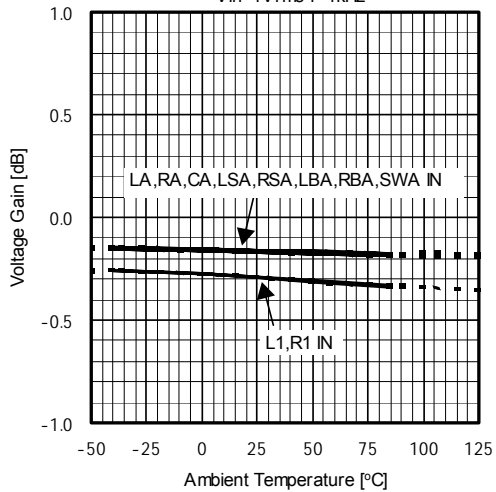

Attenuation Level vs. Ambient Temperature
V+=7V V=-7V Vin=1Vrms f=1kHz
Volume=100dB

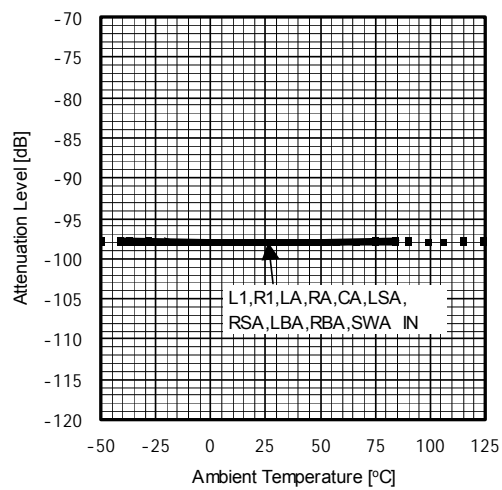

Attenuation Level vs. Ambient Temperature
V+=7V V=-7V Vin=1Vrms f=1kHz
Volume=Mute

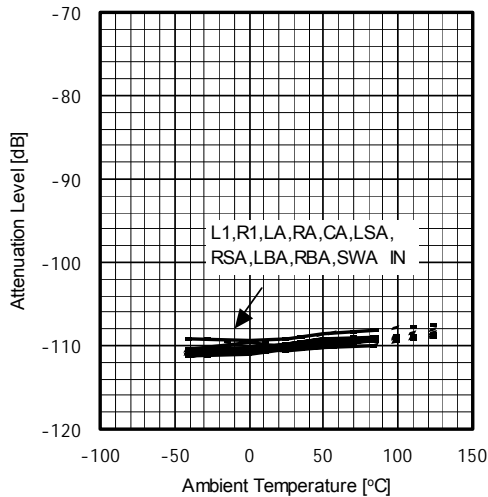

Attenuation Level vs. Ambient Temperature
V+=7V V=-7V Vin=1Vrms f=1kHz
Volume=60dB

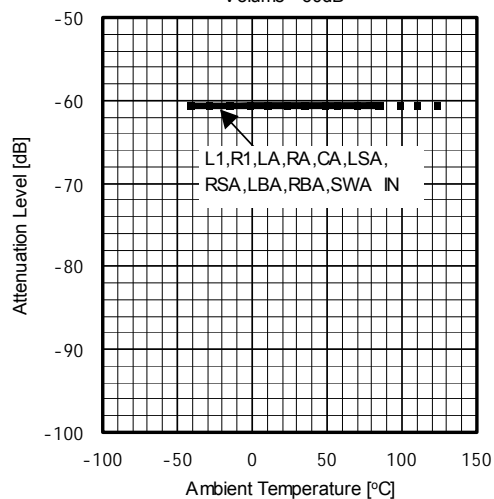

TYPICAL CHARACTERISTICS

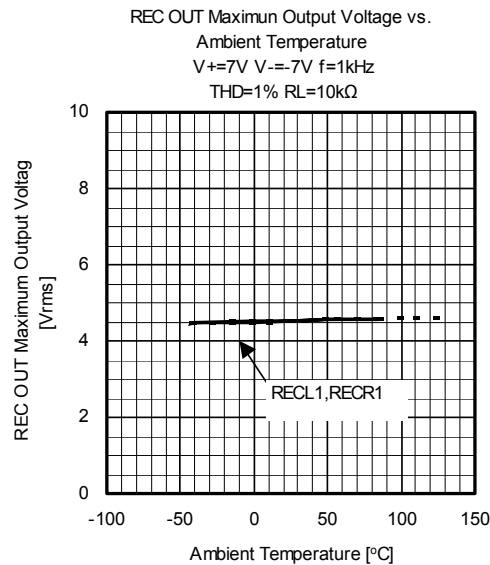
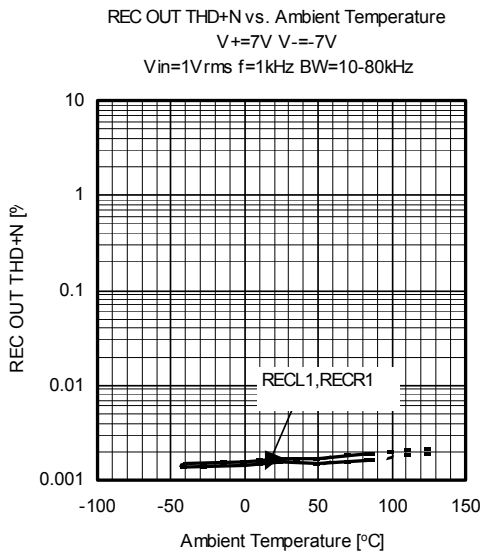
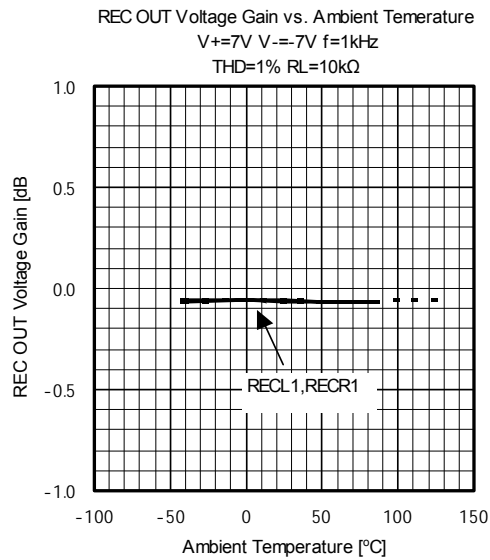
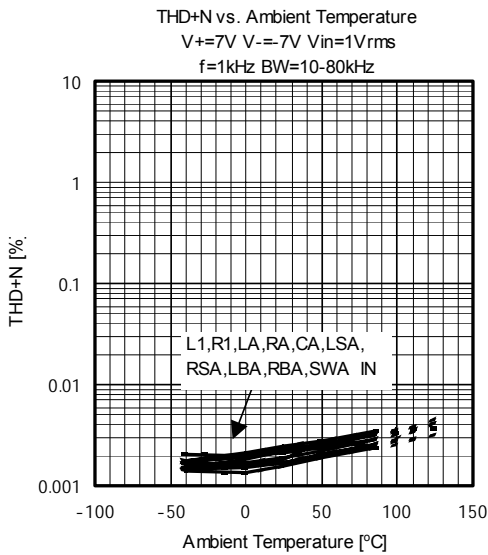
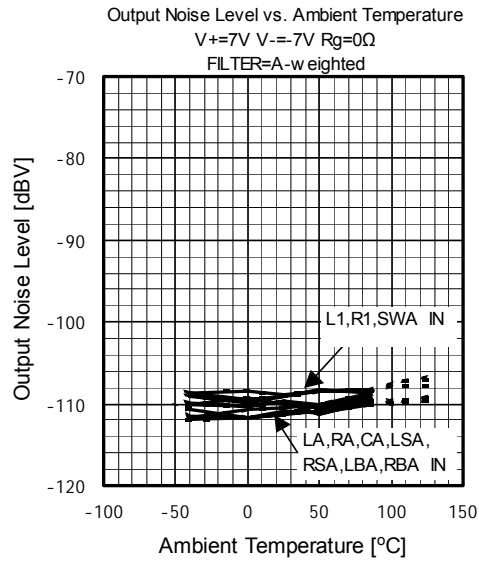
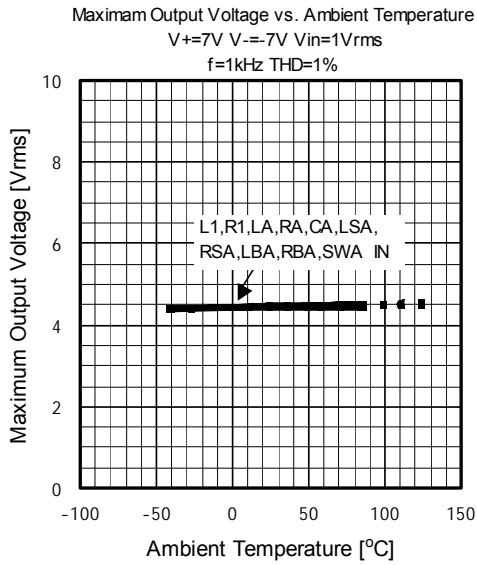

TYPICAL CHARACTERISTICS

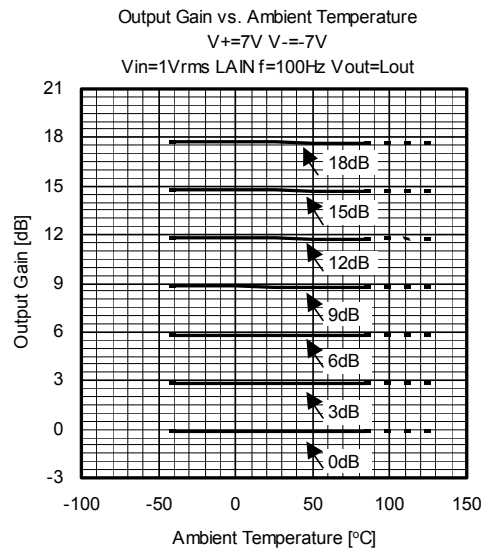
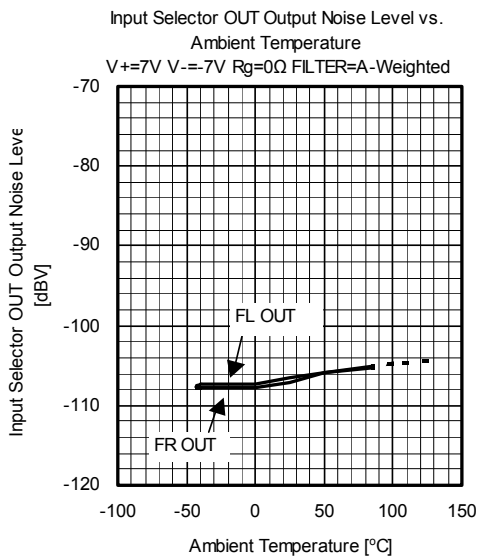
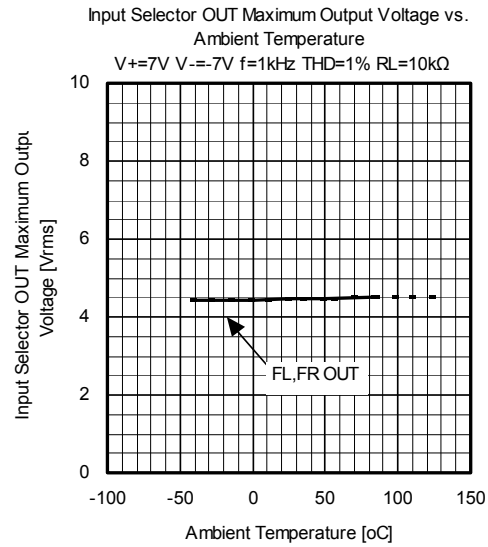
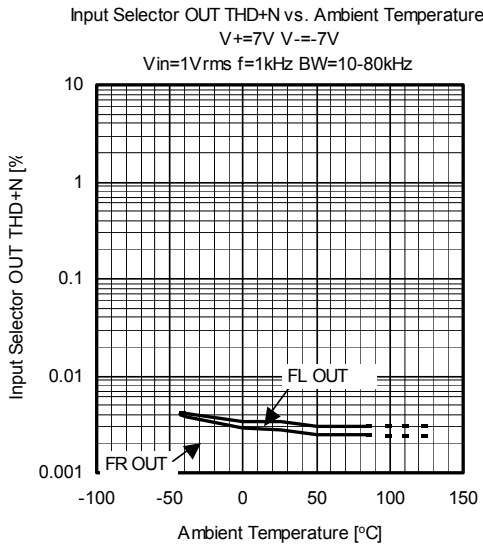
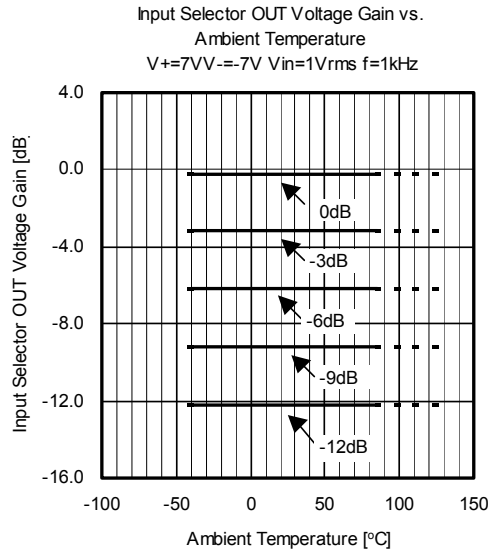
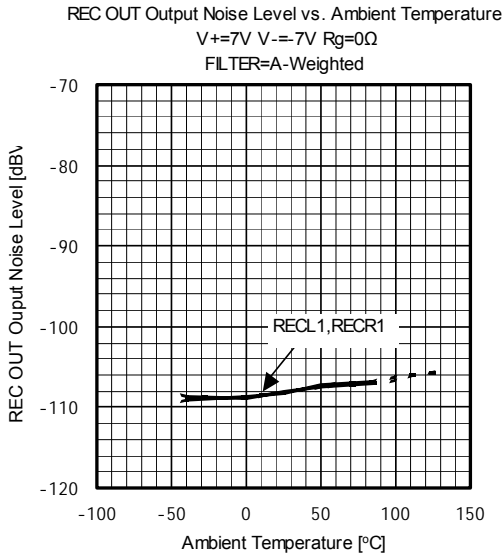

■ TYPICAL CHARACTERISTICS

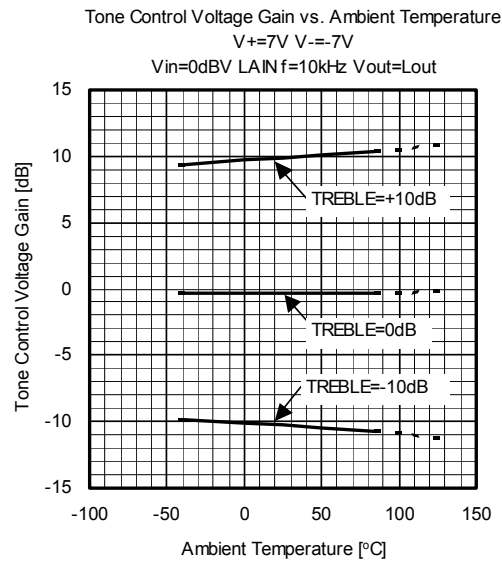
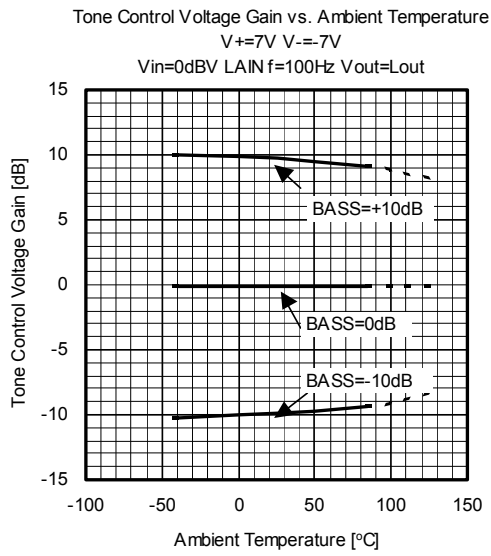

[CAUTION]

The specifications on this databook are only given for information, without any guarantee as regards either mistakes or omissions. The application circuits in this databook are described only to show representative usages of the product and not intended for the guarantee or permission of any right including the industrial rights.