

Type ABR Wi-Fi® Module

NXP 88MW320 Chipset for 802.11b/g/n WLAN Module -
Rev. C

- Design Name: Type ABR
- P/N: CMWC1ZZABR-107



Table of Contents

1 Scope	5
2 Key Features	5
3 Ordering Information	5
4 Block Diagram	6
5 FCC/IC	6
6 Construction, Dimensions, Marking and Terminal Configurations	7
6.1 Construction	7
6.2 Dimensions	7
6.3 Label Marking	8
6.4 Pin Assignments	9
6.5 Recommended Land Pattern	10
6.6 Pin Description	10
6.7 Configuration Pins	12
7 Range	12
7.1 Absolute Maximum Rating ($T_a = 25\text{ }^\circ\text{C}$, $Z = 50\ \Omega$)	12
7.2 Operating Conditions	12
8 RoHS Compliance	13
9 RF Characteristics for IEEE 802.11	13
10 Power Consumption	13
11 Power-On Sequence	14
12 Electrical Characteristics	14
12.1 I/O Static Ratings (3.3V)	14
12.2 Clock Specifications (Optional)	15
12.2.1 RC32K Specifications	15
12.2.2 Crystal Specifications (32.768 kHz)	15
13 PCB Antenna Layout Guidance	15
14 Package	16
15 Radio Regulatory Certification by Country for CMWC1ZZABR-107	18
15.1 FCC	18
15.1.1 Power Level for FCC and ISED	19
15.1.2 Theory of Operation for FCC and ISED	19
15.2 ISED	19
15.2.1 Label of the End Product	19
15.2.2 Radiation Exposure Statement	19
15.3 Europe	20

15.3.1 Power Level for Europe	20
15.3.2 Theory of Operation for Europe	20
16 Notice	21
16.1 Storage Conditions.....	21
16.2 Handling Conditions	21
16.3 Standard PCB Design (Land Pattern and Dimensions)	21
16.4 Notice for Chip Placer	22
16.5 Soldering Conditions	22
16.6 Cleaning.....	22
16.7 Operational Environment Conditions	23
16.8 Input Power Capacity	23
17 Preconditions to Use Our Products	24
Revision History.....	26

Figures

Figure 1: Block Diagram	6
Figure 2: Construction, Dimensions, Marking and Terminal Configurations	7
Figure 3: Pin Assignments Top View	9
Figure 4: Recommended Land Pattern	10
Figure 5: Power-On Sequence.....	14
Figure 6: Package.....	16
Figure 7: Inner and Outer Box.....	17
Figure 8: Reflow Soldering Standard Conditions (Example).....	22

Tables

Table 1: Document Conventions.....	4
Table 2: Ordering Part Number.....	5
Table 3: Dimensions	7
Table 4: Label Markings.....	8
Table 5: Pin Descriptions	10
Table 6: Configuration Pins.....	12
Table 7: Absolute Maximum Ratings.....	12
Table 8: Operating Conditions	12
Table 9: RF Characteristics	13
Table 10: Power Consumption.....	13
Table 11: I/O Static Ratings (3.3V).....	14
Table 12: RC32K Specifications	15
Table 13: Crystal Specifications (32.768 kHz).....	15

Table 14: FCC/ISED Power Level WLAN Per Antenna Port	19
Table 15: FCC/ISED Theory of Operation.....	19
Table 16: Europe Power Level WLAN Per Antenna Port.....	20
Table 17: Europe Theory of Operation.....	20

About This Document

Murata's Type ABR is a small module with integrated PCB antenna based on NXP 88MW320 (wireless microcontroller), supporting IEEE 802.11 b/g/n. This datasheet describes Type ABR module in detail.



Please be aware that an important notice concerning availability, standard warranty and use in critical applications of Murata products and disclaimers thereto appears at the end of this specification sheet.









Audience & Purpose

Intended audience includes any customer looking to integrate this module into their product, specifically RF, hardware, software, and systems engineers.

Document Conventions

Table 1 describes the document conventions.

Table 1: Document Conventions

Conventions	Description
	Warning Note Indicates very important note. Users are strongly recommended to review.
	Info Note Intended for informational purposes. Users should review.
	Menu Reference Indicates menu navigation instructions. Example: Insert → Tables → Quick Tables → Save Selection to Gallery 
	External Hyperlink This symbol indicates a hyperlink to an external document or website. Example: Embedded Artists AB  Click on the text to open the external link.
	Internal Hyperlink This symbol indicates a hyperlink within the document. Example: Scope  Click on the text to open the link.
<code>Console input/output or code snippet</code>	Console I/O or Code Snippet This text Style denotes console input/output or a code snippet.
<code># Console I/O comment // Code snippet comment</code>	Console I/O or Code Snippet Comment This text Style denotes a console input/output or code snippet comment. <ul style="list-style-type: none"> • Console I/O comment (preceded by "#") is for informational purposes only and does not denote actual console input/output. • Code Snippet comment (preceded by "//") may exist in the original code.

1 Scope

This product specification is applied to the IEEE 802.11b/g/n WLAN module used for consumer applications.

2 Key Features

- ◆ NXP 88MW320 inside
- ◆ Supports IEEE 802.11b/g/n specification: 2.4 GHz
- ◆ Interface: UART, GPIO
- ◆ Reference Clock: Internal (external optional sleep clock)
- ◆ ROM: SPI Flash on module (2 Mbytes)
- ◆ Antenna: Integrated PCB antenna
- ◆ Certification: FCC/CE/IC
- ◆ Dimensions: 22.0 x 19.0 x 2.4 mm
- ◆ MSL: 3
- ◆ RoHS compliant



This module is delivered with pre-programmed test FW for RF evaluation.

3 Ordering Information

Table 2 shows the part number and composition for Type ABR module.

Table 2: Ordering Part Number

Ordering Part Number	Description
CMWC1ZZABR-107	Module order
CMWC1ZZABR-107SMP	Sample module order (If module samples are not available through distribution, contact Murata referencing this part number)
CMWC1ZZABR-107-EVB	Murata Type ABR M.2 EVB (contact Murata as this is special order item)

4 Block Diagram

The Type ABR module block diagram is presented in **Figure 1**.

Figure 1: Block Diagram

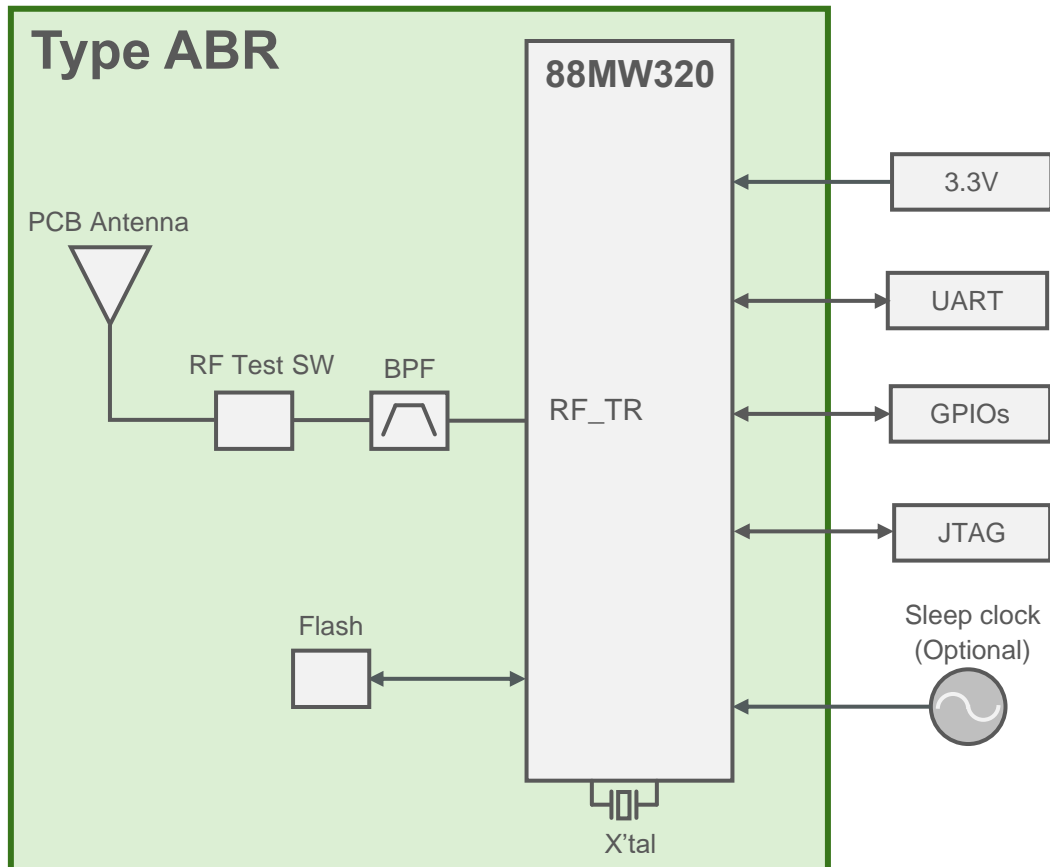

5 FCC/IC

The certificate information of Type ABR module is listed below:

- FCC ID: VPYCMWC1ZZABR
- IC ID: 772C-CMWC1ZZABR

6 Construction, Dimensions, Marking and Terminal Configurations

This section describes the construction, dimensions, marking, terminal, and pin configuration for Type ABR module.

6.1 Construction

Figure 2 shows the Type ABR construction diagram.

Figure 2: Construction, Dimensions, Marking and Terminal Configurations

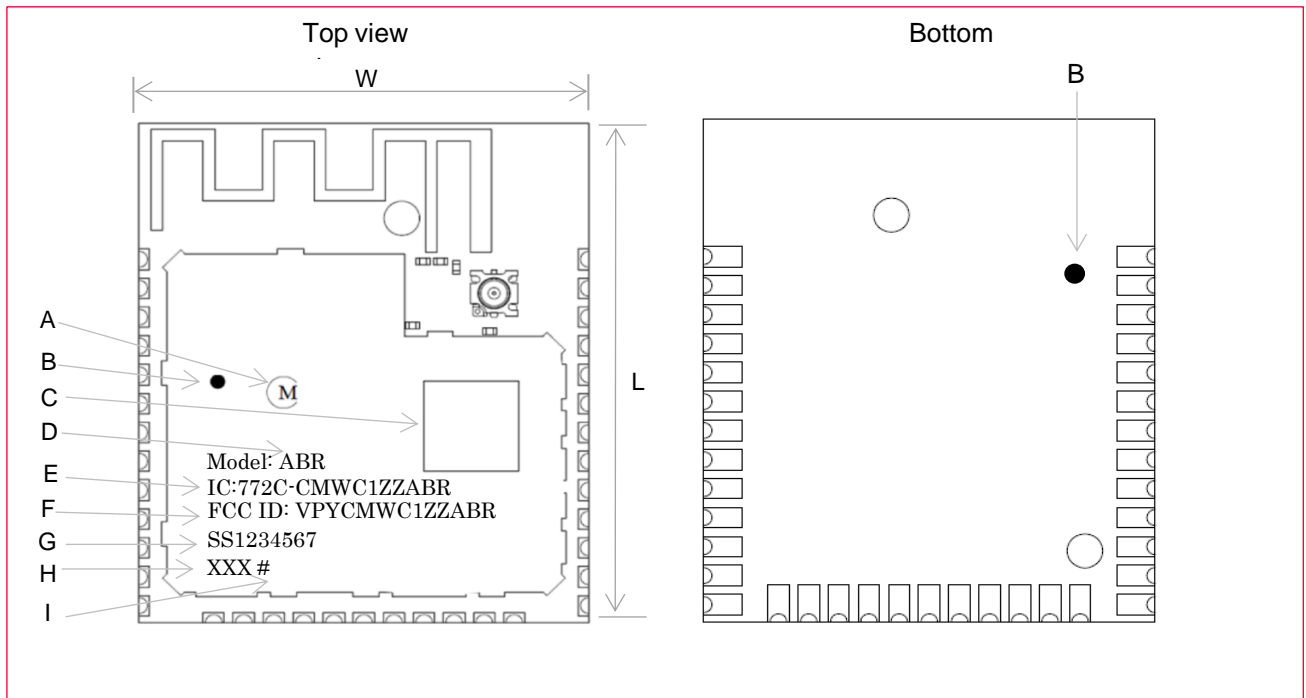

6.2 Dimensions

Table 3 describes the Type ABR dimensions in millimeters (mm).

Table 3: Dimensions

Mark	Minimum (mm)	Typical	Maximum (mm)
L	21.8	22	22.2
W	18.8	19	19.2
T		2.4	2.55

6.3 Label Marking

Table 4 describes the Type ABR markings.

Table 4: Label Markings

Marking	Meaning
A	Murata logo
B	Pin 1 indicator
C	2D barcode (MAC address)
D	Model Name / P/N
E	IC certification ID
F	FCC certification ID
G	Inspection code
H	Sub type number: 107
I	Version code

6.4 Pin Assignments

This section describes the Type ABR pin assignments, descriptions, and configurations. The pin assignments (top view) are shown in **Figure 3**.

Figure 3: Pin Assignments Top View

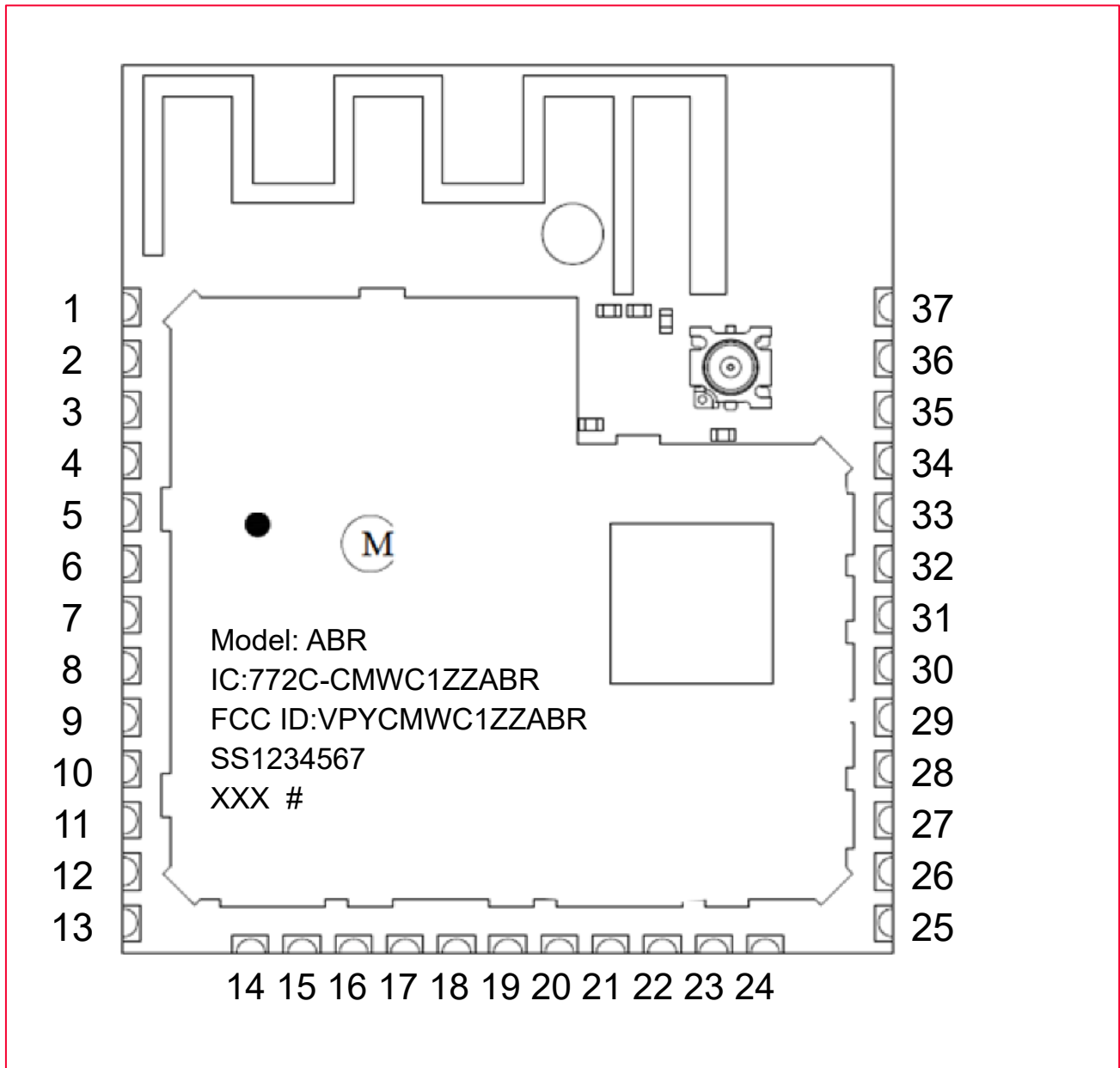

6.5 Recommended Land Pattern

Figure 4 shows the recommended land pattern for Type ABR module.

Figure 4: Recommended Land Pattern

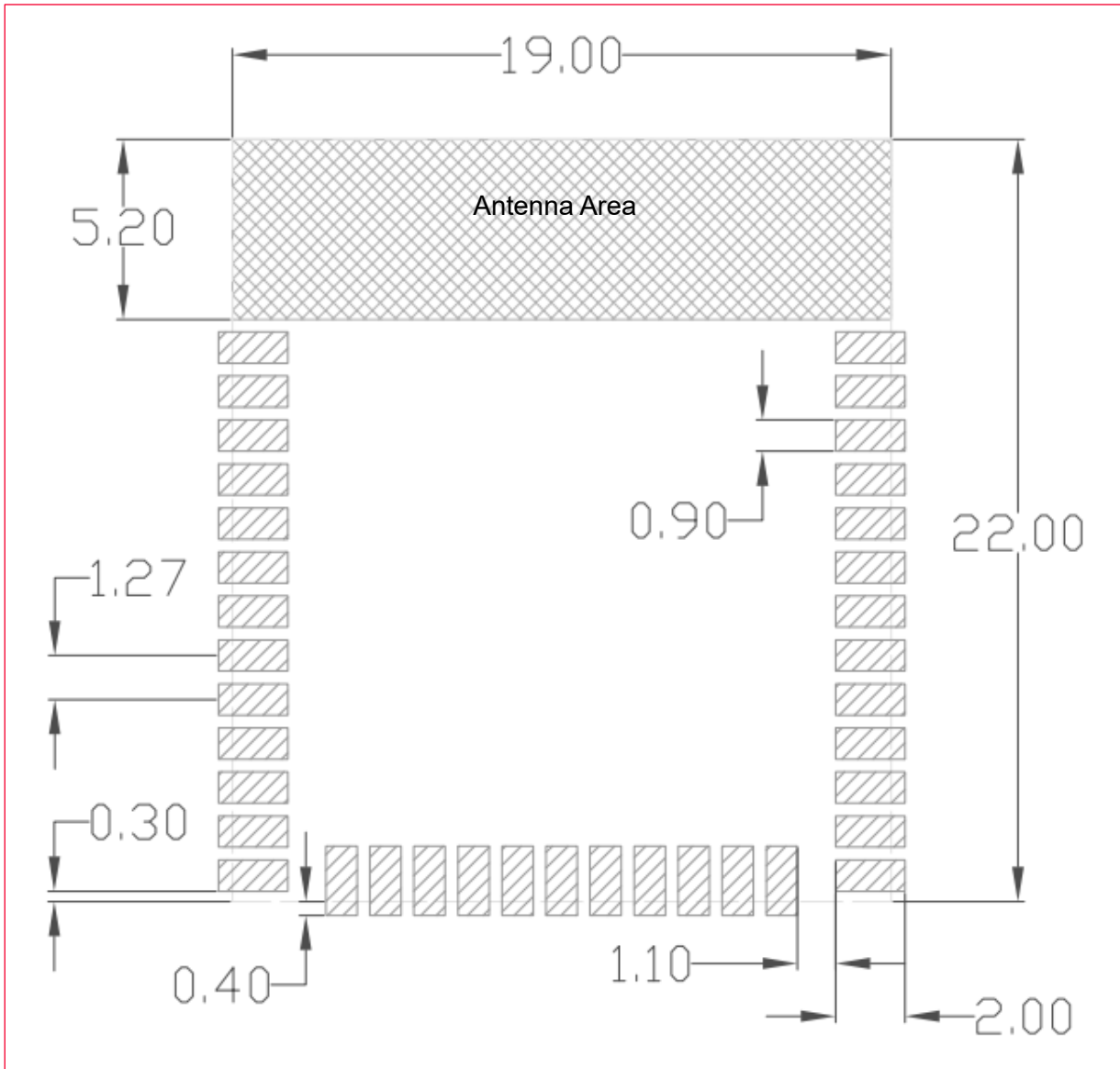

6.6 Pin Description

Table 5 has the pin descriptions for Type ABR.

Table 5: Pin Descriptions

No.	Name	Function	I/O	MW320 Pin No.	MW320 Pin Function
1	GPIO_16	CON[5]: Configuration Bit	I/O	30	GPIO_16
2	RESET_N	Module Reset (active low)	I	35	RESETn
3	GPIO_22	NC		36	GPIO_22

No.	Name	Function	I/O	MW320 Pin No.	MW320 Pin Function
4	GPIO_23	Functional Button Pin (optional)	I	37	GPIO_23
5	GPIO_24	NC		38	GPIO_24
6	GND				
7	GPIO_25	32.768 kHz Crystal Input / Oscillator Input	I	39	GPIO_25
8	GPIO_26	32.768 kHz Crystal Output	O	40	GPIO_26
9	GND				
10	GPIO_27	CON[4]: Configuration Bit	I/O	51	GPIO_27
11	GPIO_39	NC		52	GPIO_39
12	GND				
13	VDD33	3.3V DC Power Supply	P		
14	GPIO_40	LED_1: Module Status Indication (optional)	O	55	GPIO_40
15	GPIO_41	LED_2: Link Status Indication (optional)	O	56	GPIO_41
16	GPIO_42	NC		58	GPIO_42
17	GPIO_43	NC		59	GPIO_43
18	GPIO_44	NC		60	GPIO_44
19	GPIO_45	NC		61	GPIO_45
20	GND				
21	GPIO_46	NC		62	GPIO_46
22	GPIO_47	NC		63	GPIO_47
23	GPIO_48	Debug Log (optional)	O	64	GPIO_48
24	GPIO_49	NC		65	GPIO_49
25	GPIO_0	UART CTS (optional)	I	1	GPIO_0
26	GPIO_1	UART RTS (optional)	O	2	GPIO_1
27	GPIO_2	UART Transmit	O	3	GPIO_2
28	GPIO_3	UART Receive	I	4	GPIO_3
29	GND				
30	GPIO_4	NC		6	GPIO_4
31	GPIO_5	NC		7	GPIO_5
32	GND				
33	GPIO_6	TDO: JTAG Test Data (optional)	O	8	GPIO_6
34	GPIO_7	TCK: JTAG Test Clock (optional)	I	9	GPIO_7
35	GPIO_8	TMS: JTAG Controller Select (optional)	I/O	10	GPIO_8
36	GPIO_9	TDI: JTAG Test Data (optional)	I	11	GPIO_9
37	GPIO_10	TRSTn: JTAG Test Reset (active low) (optional)	I	12	GPIO_10

6.7 Configuration Pins

Table 6 shows the pins used as configuration inputs to set parameters following a reset. The definition of these pin changes immediately after reset to their usual function. To set a configuration bit to 0, attach a 100 k Ω resistor from the pin to ground. No external circuitry is required to set a configuration bit to 1.

Table 6: Configuration Pins

Configuration Bits	Pin name	Configuration Function
CON[5]	GPIO_16	Boot Options <ul style="list-style-type: none"> • 00 = boot from UART • 01 = reserved • 10 = reserved • 11 = boot from Flash (default)
CON[4]	GPIO_27	

7 Range

This section describes the absolute maximum ratings and operating conditions for Type ABR module.

7.1 Absolute Maximum Rating ($T_a = 25\text{ }^{\circ}\text{C}$, $Z = 50\text{ }\Omega$)

Table 7 shows the absolute maximum ratings of Type ABR module.

Table 7: Absolute Maximum Ratings

Parameter	Condition	Rating	Units
Storage Temperature		-40 /+85	$^{\circ}\text{C}$
Supply Voltage	VDD33 $T_a = 25^{\circ}\text{C}$	3.6	V



Stresses in excess of the absolute ratings may cause permanent damage. Functional operation is not implied under these conditions. Exposure to absolute ratings for extended periods of time may adversely affect reliability. No damage assuming only one parameter is set at limit at a time with all other parameters are set within operating condition.

7.2 Operating Conditions

Table 8 lists the operating conditions for Type ABR.

Table 8: Operating Conditions

Parameter	Minimum	Maximum	Units
Operating Temperature	-30	+85	$^{\circ}\text{C}$
Supply Voltage	VDD33 3.0	3.6	V



1. Functionality is guaranteed but specifications require derating at extreme temperatures.
2. This module is not approved for use when being powered by AC power lines, either directly or indirectly through another device.

8 RoHS Compliance

This component can meet with RoHS compliance.

9 RF Characteristics for IEEE 802.11

This section describes the RF Characteristics for IEEE 802.11.

Conditions: 25 °C, VDD33 = 3.3V

Table 9 shows the RF characteristics of Type ABR module.

Table 9: RF Characteristics

Tx Power Level	Minimum	Typical	Maximum	Units
802.11b (11 Mbps)		17		dBm
802.11g (54 Mbps)		15		dBm
802.11n (HT20 MCS7)		14		dBm
Rx Minimum Input Level Sensitivity	Minimum	Typical	Maximum	Units
802.11b (11 Mbps)			-76	dBm
802.11g (54 Mbps)			-65	dBm
802.11n (HT20 MCS7)			-64	dBm



1. Test performed through Murata RF switch connector P/N: MM8030-2610.
2. For compliance of FCC regulation, it is necessary to set output power as below table.

10 Power Consumption

This section describes the power consumption.

Conditions: 25 °C, VDD33 = 3.3V, Tx on continuous mode

Table 10 describes the power consumption.

Table 10: Power Consumption

Condition	Typical	Maximum	Units
802.11b (11 Mbps), Tx power = 17 dBm	303	365	mA
802.11g (54 Mbps), Tx power = 15 dBm	285	330	mA
802.11n (HT20 MCS7), Tx power = 14 dBm	282	325	mA
Rx Idle	83	100	mA

11 Power-On Sequence

Figure 5 shows the power-on sequence.

Figure 5: Power-On Sequence

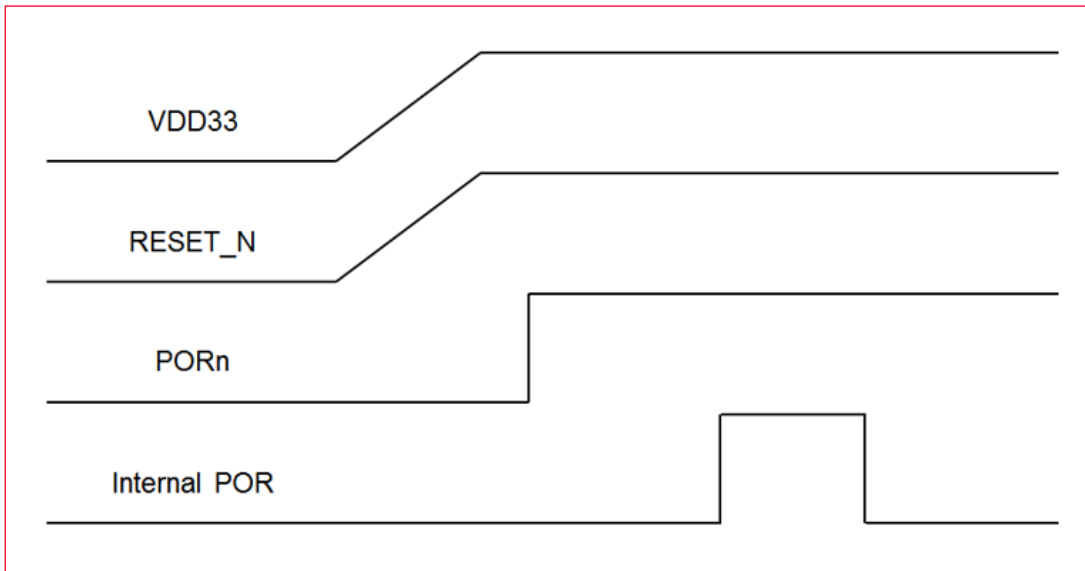

12 Electrical Characteristics

This section describes the I/O static ratings and clock specifications (optional).

12.1 I/O Static Ratings (3.3V)

Table 11 describes the I/O Static Ratings.

Table 11: I/O Static Ratings (3.3V)

Symbol	Parameter	Condition	Minimum	Typical	Maximum	Units
V _{IL}	Input low voltage		-0.4		VDD33*30%	V
V _{IH}	Input high voltage		VDD33*70%		VDD33+0.4	V
V _{HYS}	Input hysteresis		150			mV
I _{OL} @0.4V			4			mA
I _{OH} @VDDIO-0.5V			3			mA
Input capacitance					5	pF
Input leakage 1		VDD33 is ON, 0<V(PAD)<VDD33			5	μA

12.2 Clock Specifications (Optional)

This section describes the clock specifications (optional): RC32K specifications and crystal specifications (32.768 kHz).

12.2.1 RC32K Specifications

Table 12 describes the RC32K Specifications.

Table 12: RC32K Specifications

Parameter	Condition	Minimum	Typical	Maximum	Units
Frequency before calibration		18.6	31.8	39.8	kHz
Startup time			0.9		ms
After-calibration frequency accuracy	Use 32.768 kHz crystal as reference clock	32.3	32.7	33.1	kHz
Temperature tolerance			65		ppm/C
Duty cycle		40	50	60	%

12.2.2 Crystal Specifications (32.768 kHz)

Table 13 has the crystal specifications.

Table 13: Crystal Specifications (32.768 kHz)

Parameter	Condition	Minimum	Typical	Maximum	Units
Crystal frequency			32.768		kHz
Frequency accuracy tolerance		-40		40	ppm
Startup time				600	ms
Duty cycle tolerance			50		%
Crystal load capacitance			12.5		pF
Crystal shunt capacitance				7	pF
Equivalent Series Resistance (ESR)				100	kΩ

13 PCB Antenna Layout Guidance

If to use internal PCB antenna, some guides must be followed in order to get best antenna performance.

1. Place the antenna area on the corner or edge of the main board.
2. No ground, circuit, component under the antenna area, including the reverse side of PCB. No ground area is as large as possible.
3. Metal component should be at least 10 mm away from PCB antenna.
4. Plastic case should be at least 10 mm away from PCB antenna. If it's metal case, it's recommended to use external antenna.

14 Package

This module product is packaged in tray as shown in Figure 6: Package.

Figure 6: Package

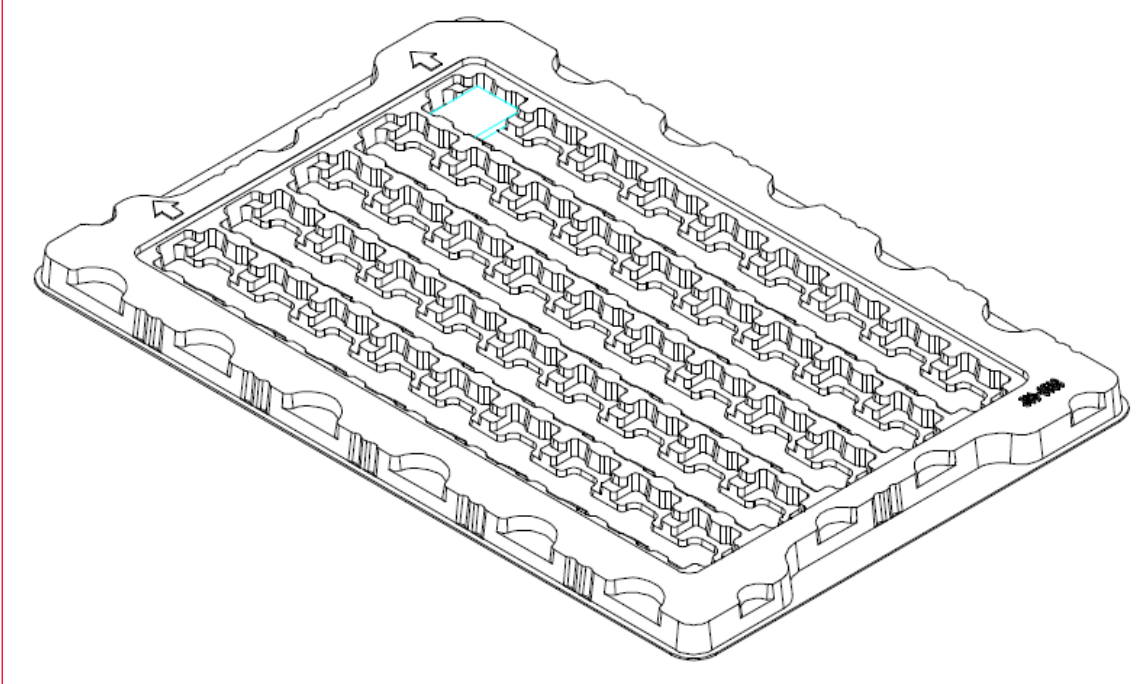

- 1 tray: 45 pcs products
- 1 inner box: 6 trays with products
- 1 outer box: 4 inner boxes
- MOQ: 1080 pcs

Figure 7 shows the inner and outer boxes of the product.

Figure 7: Inner and Outer Box

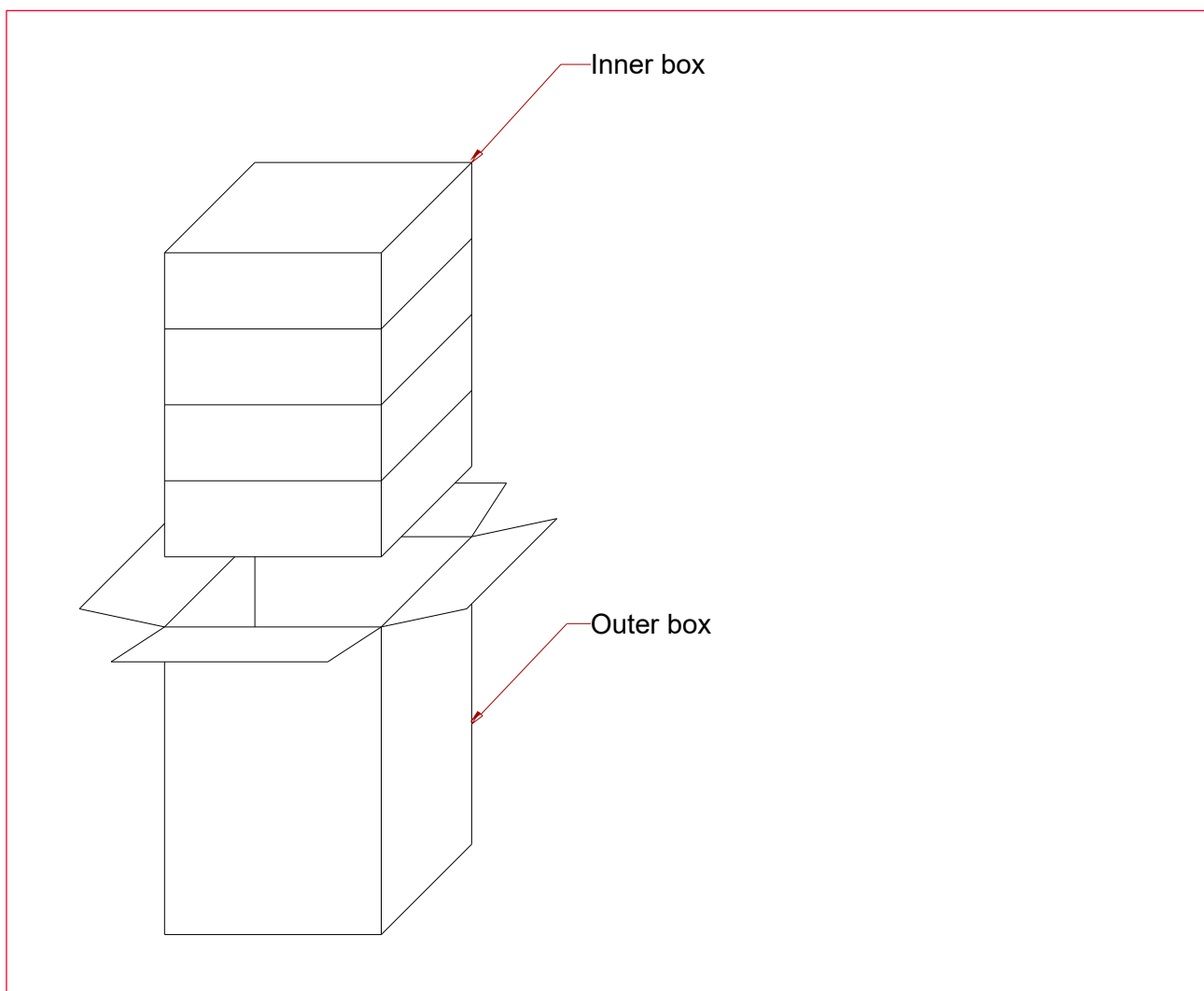

15 Radio Regulatory Certification by Country for CMWC1ZZABR-107

This section includes regulatory certification information for following regions:

- FCC
- ISED
- Europe

15.1 FCC

This module has been tested and found to comply with the FCC Part15.

These limits are designed to provide reasonable protection against harmful interference in approved installations.

This equipment generates, uses, and can radiate radio frequency energy and, if not installed and used in accordance the instructions, may cause harmful interference to radio communications.

However, there is no guarantee that interference will not occur in a particular installation.



This device complies with part 15 of the FCC Rules. Operation is subject to the following two conditions:

- This device may not cause harmful interference.
- This device must accept any interference received, including interference that may cause undesired operation.

Modifications or changes to this equipment not expressly approved by Murata Manufacturing Co., Ltd. may void the user's authority to operate this equipment.

The modular transmitter must be equipped with either a permanently affixed label or must be capable of electronically displaying its FCC identification number:

1. If using a permanently affixed label, the modular transmitter must be labeled with its own FCC identification number; and if the FCC identification number is not visible when the module is installed inside another device, the outside of the device into which the module is installed must also display a label referring to the enclosed module. This exterior label can use wording such as the following: "Contains Transmitter Module FCC ID: [VPYCMWC1ZZABR]" or "Contains FCC ID: [VPYCMWC1ZZABR]."
2. If the modular transmitter uses an electronic display of the FCC identification number, the information must be readily accessible and visible on the modular transmitter or on the device in which it is installed. If the module is installed inside another device, then the outside of the device into which the module is installed must display a label referring to the enclosed module. This exterior label can use wording such as the following: "Contains FCC certified transmitter module(s)."



To satisfy FCC RF Exposure requirements for mobile and base station transmission devices, a separation distance of 20 cm or more should be maintained between the antenna of this device and persons during operation. To ensure compliance, operation at closer than this distance is not recommended.



The antenna(s) used for this transmitter must not be co-located or operating in conjunction with any other antenna or transmitter.

15.1.1 Power Level for FCC and ISED

Table 14 shows the FCC/ISED transmit power table corresponding to channel number and mode.

Table 14: FCC/ISED Power Level WLAN Per Antenna Port

11b			11g			11n		
CH1	CH2-10	CH11	CH1	CH2-10	CH11	CH1	CH2-10	CH11
17	17	17	12	15	10	10	14	8

15.1.2 Theory of Operation for FCC and ISED

Table 15 shows the theory of operation table for FCC/ISED.

Table 15: FCC/ISED Theory of Operation

Frequency of Operation		Scan	Ad-hoc mode	
2.4 GHz	11b/g/n (HT20)	2412 - 2472 MHz	Active	Yes

15.2 ISED

15.2.1 Label of the End Product

The final end product must be labeled in a visible area with the following "Contains transmitter module IC: [772C-CMWC1ZZABR] "

English Version This Class B digital apparatus complies with Canadian ICES-003.
French Version Cet appareil numérique de la classe B est conforme à la norme NMB-003 du Canada.

English Version This device complies with RSS-247 of the Industry Canada Rules. Operation is subject to the following two conditions: 1. This device may not cause harmful interference, and 2. This device must accept any interference received, including interference that may cause undesired operation.
French Version Ce dispositif est conforme à la norme CNR-247 d'Industrie Canada applicable aux appareils radio exempts de licence. Son fonctionnement est sujet aux deux conditions suivantes: 1. le dispositif ne doit pas produire de brouillage préjudiciable, et 2. ce dispositif doit accepter tout brouillage reçu, y compris un brouillage susceptible de provoquer un fonctionnement indésirable.

15.2.2 Radiation Exposure Statement

English Version This equipment complies with IC radiation exposure limits set forth for an uncontrolled environment. This equipment should be installed and operated with minimum distance 20 cm between the radiator & your body.
French Version

Déclaration d'exposition aux radiations:

Cet équipement est conforme aux limites d'exposition aux rayonnements IC établies pour un environnement non contrôlé. Cet équipement doit être installé et utilisé avec un minimum de 20 cm de distance entre la source de rayonnement et votre corps.

15.3 Europe

This section describes the typical Tx output power level at module antenna port.

- Condition
 - VDD33 = 3.6V

15.3.1 Power Level for Europe

Table 16 shows the per antenna port power table for 2.4GHz for Europe.

Table 16: Europe Power Level WLAN Per Antenna Port

Mode	Tx Output Power Level [dBm]		
	11b (11 Mbps)	11g (54 Mbps)	11n (MCS7)
Chan 1	17	15	14
Chan 7	17	15	14
Chan 13	17	15	14

15.3.2 Theory of Operation for Europe

Table 17 shows the theory of operation table for Europe.

Table 17: Europe Theory of Operation

Frequency of Operation		Scan	Ad-hoc mode	
2.4 GHz	11b/g/n (HT20)	2412 - 2472 MHz	Active	Yes

16 Notice

16.1 Storage Conditions

- Please use this product within 6 months after receipt.
- The product shall be stored without opening the packing under the ambient temperature from 5 to 35 °C and humidity from 20 ~ 70 %RH (Packing materials may be deformed at the temperature over 40 °C).
- The product left more than 6 months after reception; it needs to be confirmed the solderability before used.
- The product shall be stored in noncorrosive gas (Cl₂, NH₃, SO₂, NO_x, etc.).
- Any excess mechanical shock including, but not limited to, sticking the packing materials by sharp object and dropping the product, shall not be applied in order not to damage the packing materials.
- This product is applicable to MSL3 (Based on IPC/JEDEC J-STD-020)
 - After the packing opened, the product shall be stored at <30 °C / <60 %RH and the product shall be used within 168 hours.
 - When the color of the indicator in the packing changed, the product shall be baked before soldering.
- Baking condition: 125 +5/-0 °C, 24 hours, 1 time
- The products shall be baked on the heat-resistant tray because the material is not heat-resistant.

16.2 Handling Conditions

- Be careful in handling or transporting products because excessive stress or mechanical shock may break products.
- Handle with care if products may have cracks or damages on their terminals, the characteristics of products may change. Do not touch products with bare hands that may result in poor solderability.

16.3 Standard PCB Design (Land Pattern and Dimensions)

- All the ground terminals should be connected to the ground patterns. Furthermore, the ground pattern should be provided between IN and OUT terminals. Please refer to the specifications for the standard land dimensions.
- The recommended land pattern and dimensions is as Murata's standard. The characteristics of products may vary depending on the pattern drawing method, grounding method, land dimensions, land forming method of the NC terminals and the PCB material and thickness. Therefore, be sure to verify the characteristics in the actual set. When using non-standard lands, contact Murata beforehand.

16.4 Notice for Chip Placer

When placing products on the PCB, products may be stressed and broken by uneven forces from a worn-out chucking locating claw or a suction nozzle. To prevent products from damages, be sure to follow the specifications for the maintenance of the chip placer being used. For the positioning of products on the PCB, be aware that mechanical chucking may damage products.

16.5 Soldering Conditions

The recommended reflow soldering conditions of soldering are shown in **Figure 8**.

When products are immersed in solvent after mounting, pay special attention to maintain the temperature difference within 100 °C. Soldering must be carried out by the above-mentioned conditions to prevent products from damage. Set up the highest temperature of reflow within 260 °C. Contact Murata before use if concerning other soldering conditions.

Figure 8: Reflow Soldering Standard Conditions (Example)

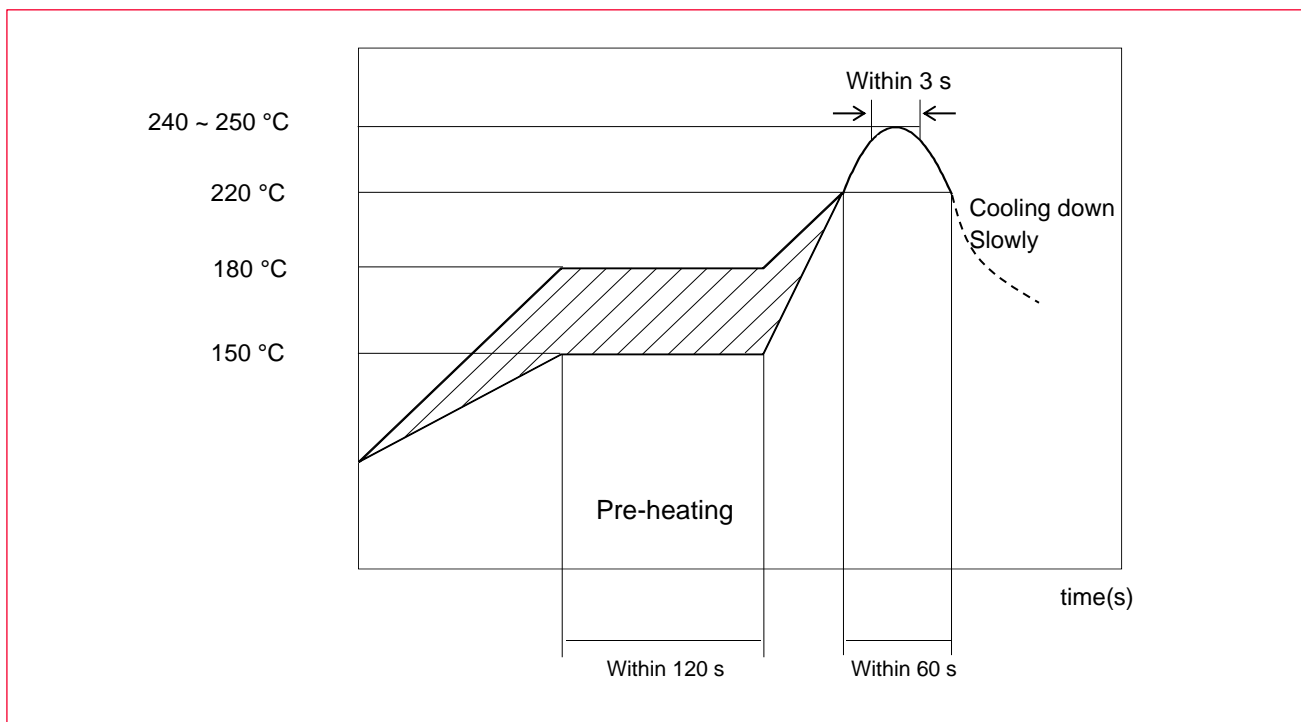

Please use the reflow within 2 times.

Use rosin type flux or weakly active flux with a chlorine content of 0.2 wt % or less.

16.6 Cleaning

Since this Product is Moisture Sensitive, any cleaning is not permitted. If any cleaning process is done the customer is responsible for any issues or failures caused by such process.

16.7 Operational Environment Conditions

Products are designed to work for electronic products under normal environmental conditions (ambient temperature, humidity and pressure). Therefore, products have no problems to be used under the similar conditions to the above-mentioned. However, if products are used under the following circumstances, it may damage products and leakage of electricity and abnormal temperature may occur.

- In an atmosphere containing corrosive gas (Cl₂, NH₃, SO_x, NO_x, etc.).
- In an atmosphere containing combustible and volatile gases.
- Dusty place.
- Direct sunlight place.
- Water splashing place.
- Humid place where water condenses
- Freezing place.



If there are possibilities for products to be used under the preceding clause, consult with Murata before actual use.



Do not apply static electricity or excessive voltage while assembling and measuring, as it might be a cause of degradation or destruction to apply static electricity to products.

16.8 Input Power Capacity

Products shall be used in the input power capacity as specified in these specifications.

Inform Murata beforehand, in case that the components are used beyond such input power capacity range.

17 Preconditions to Use Our Products



PLEASE READ THIS NOTICE BEFORE USING OUR PRODUCTS.

Please make sure that your product has been evaluated and confirmed from the aspect of the fitness for the specifications of our product when our product is mounted to your product.

All the items and parameters in this product specification/datasheet/catalog have been prescribed on the premise that our product is used for the purpose, under the condition and in the environment specified in this specification. You are requested not to use our product deviating from the condition and the environment specified in this specification.

Please note that the only warranty that we provide regarding the products is its conformance to the specifications provided herein. Accordingly, we shall not be responsible for any defects in products or equipment incorporating such products, which are caused under the conditions other than those specified in this specification.

WE HEREBY DISCLAIM ALL OTHER WARRANTIES REGARDING THE PRODUCTS, EXPRESS OR IMPLIED, INCLUDING WITHOUT LIMITATION ANY WARRANTY OF FITNESS FOR A PARTICULAR PURPOSE, THAT THEY ARE DEFECT-FREE, OR AGAINST INFRINGEMENT OF INTELLECTUAL PROPERTY RIGHTS.

You agree that you will use any and all software or program code (including but not limited to hcd, firmware, nvram, and blob) we may provide or to be embedded into our product ("Software") provided that you use the Software bundled with our product. YOU AGREE THAT THE SOFTWARE SHALL BE PROVIDED TO YOU "AS IS" BASIS, MURATA MAKES NO REPRESENTATIONS OR WARRANTIES THAT THE SOFTWARE IS ERROR-FREE OR WILL OPERATE WITHOUT INTERRUPTION. AND MORE, MURATA MAKES NO REPRESENTATIONS OR WARRANTIES OF ANY KIND WHETHER EXPRESS OR IMPLIED WITH RESPECT TO THE SOFTWARE. MURATA EXPRESSLY DISCLAIM ANY AND ALL WARRANTIES OR CONDITIONS OF MERCHANTABILITY, FITNESS FOR A PARTICULAR PURPOSE NOR THE WARRANTY OF TITLE OR NON-INFRINGEMENT OF INTELLECTUAL PROPERTY RIGHTS.

You shall indemnify and hold harmless us, our affiliates, and our licensor from and against any and all claims, costs, expenses and liabilities (including attorney's fees), which arise in connection with the using the Software.

The product shall not be used in any application listed below which requires especially high reliability for the prevention of such defect as may directly cause damage to the third party's life, body or property. You acknowledge and agree that, if you use our products in such applications, we will not be responsible for any failure to meet such requirements. Furthermore, YOU AGREE TO INDEMNIFY AND DEFEND US AND OUR AFFILIATES AGAINST ALL CLAIMS, DAMAGES, COSTS, AND EXPENSES THAT MAY BE INCURRED, INCLUDING WITHOUT LIMITATION, ATTORNEY FEES AND COSTS, DUE TO THE USE OF OUR PRODUCTS AND THE SOFTWARE IN SUCH APPLICATIONS.

- Aircraft equipment.
- Aerospace equipment.
- Undersea equipment.
- Power plant control equipment.
- Medical equipment.
- Traffic signal equipment.

- Burning / explosion control equipment.
- Disaster prevention / crime prevention equipment.
- Transportation equipment (vehicles, trains, ships, elevator, etc.).
- Application of similar complexity and/ or reliability requirements to the applications listed in the above.

We expressly prohibit you from analyzing, breaking, reverse-engineering, remodeling altering, and reproducing our product. Our product cannot be used for the product which is prohibited from being manufactured, used, and sold by the regulations and laws in the world.

We do not warrant or represent that any license, either express or implied, is granted under any our patent right, copyright, mask work right, or our other intellectual property right relating to any combination, machine, or process in which our products or services are used. Information provided by us regarding third-party products or services does not constitute a license from us to use such products or services or a warranty or endorsement thereof. Use of such information may require a license from a third party under the patents or other intellectual property of the third party, or a license from us under our patents or other intellectual property.

Please do not use our products, our technical information and other data provided by us for the purpose of developing of mass-destruction weapons and the purpose of military use.

Moreover, you must comply with "foreign exchange and foreign trade law", the "U.S. export administration regulations", etc.

Please note that we may discontinue the manufacture of our products, due to reasons such as end of supply of materials and/or components from our suppliers.

By signing on specification sheet or approval sheet, you acknowledge that you are the legal representative for your company and that you understand and accept the validity of the contents herein. When you are not able to return the signed version of specification sheet or approval sheet within 30 days from receiving date of specification sheet or approval sheet, it shall be deemed to be your consent on the content of specification sheet or approval sheet. Customer acknowledges that engineering samples may deviate from specifications and may contain defects due to their development status. We reject any liability or product warranty for engineering samples. In particular we disclaim liability for damages caused by

- The use of the engineering sample other than for evaluation purposes, particularly the installation or integration in the product to be sold by you,
- Deviation or lapse in function of engineering sample,
- Improper use of engineering samples.

We disclaim any liability for consequential and incidental damages.

If you can't agree with the above contents, please contact sales.

Revision History

Revision	Date	Changed Item	Comment
	2020.11.12	Initial release	Initial Release
A	2020.12.16	RF Characteristics,	RF Characteristics, Add output power table
B	2021.02.24	Add output power table	Revised Evaluation Board Part Number
C	2023.01.13	1. Scope 2. Part Number / Part Composition 10. Power Up Sequence 12. Reference Circuit 15. FCC/ISED Statement	<ul style="list-style-type: none"> • Added more information. • Added Key Features section. • Renamed section. • Renamed section • Moved section to HW app note. • Renamed section • Added theory of operation table for FCC/ISED • Added Europe section Updated to new format



Copyright © Murata Manufacturing Co., Ltd. All rights reserved. The information and content in this document are provided “as-is” with no warranties of any kind and are for informational purpose only. Data and information have been carefully checked and are believed to be accurate; however, no liability or responsibility for any errors, omissions, or inaccuracies is assumed.

Wi-Fi® is a registered trademark of Wi-Fi Alliance. Other brand and product names are trademarks or registered trademarks of their respective owners.

Specifications are subject to change without notice.