

# GKM Series (Global Miniature Safety Key Interlock Switch)

## FEATURES

- Red body colour
- Integrated cable or connector(s)
- Bottom or side entry cable
- 90° and straight key
- Top or side key entry
- High switching current capabilities
- Extremely compact enclosure
- Positive opening operation of Normally Closed contacts conforming to IEC/EN 60947-5-1-3
- IP 67 Enclosure rating
- Stackable design allows one switch on top of the other
- Through wiring option (dual connector)
- Dust cap for unused key entry
- Robust stainless steel keys
- UL listed; CSA certified, CE approved

## BENEFITS

- Immediately recognisable as safety component
- Reduced installation time and costs
- Flexibility in mounting/actuation options
- Switch equipment directly and through safety control modules
- Fits into extremely compact spaces
- Suitable for wet applications
- Extremely simple mechanical redundancy as well as electrical redundancy
- Very easy to apply to multiple door modular machinery - no difficulty in wiring small switch enclosures
- Durable and tough design



(Pending)

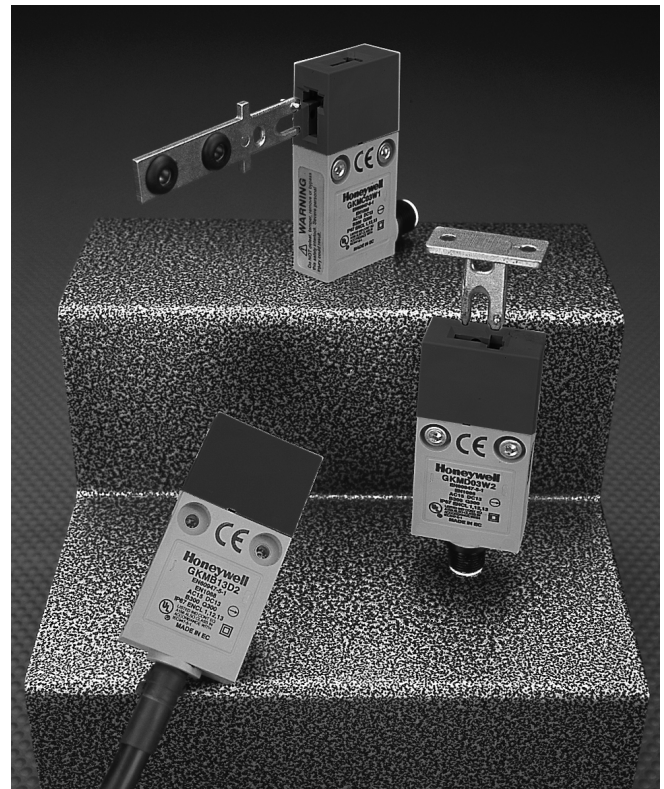

GKM

Used alone as Category 1 safety components or, in conjunction with other safety switches and our complete range of safety relays, it is possible to construct comprehensive protection schemes with Category 2, 3 or 4 compliance.

The prelead versions allow rapid fit, easy cable routing and function testing which cut costs dramatically in OEM applications. Simple upgrade guarding solution for End User applications.

Low energy basic switches are rated as follows:

Operating Voltage $U_e$	1 to 50Vac or Vdc
Operating Current $I_e$	1 microamp to 100mA

Example of catalog listing using a low energy basic switch - GKMA19W1

### **WARNING**

#### **MISUSE OF DOCUMENTATION**

- The information presented in this product sheet (or catalogue) is for reference only. DO NOT USE this document as system installation information.
- Complete installation, operation and maintenance information is provided in the instructions supplied with each product.

**Failure to comply with these instructions could result in death or serious injury.**

## GKM Series Miniature Safety Key Interlock Switches

GKM

### Technical Data

**Mechanical life** >1 Million operations

**Degree of protection** IP 66/67, EN 60529  
NEMA 1, 12, 13

**Temperature range** -25 to +85 °C  
(-13 to +185 °F)

**Approvals\*** IEC 60947-5-1,  
EN 60947-5-1, EN 1088,  
EN 60204,  
UL508,  
CSA22-2-14, UL748C  
Utilization category  
AC15, B300  
DC13, Q300

**Vibration** IEC 68-2-6  
(BS 2011, Part 2.1 Fc) 10g

**Shock** IEC 68-2-27  
(BS 2011, Part 2.1 Ea) 50g

**Minimum Door Radius** 160mm (6.3 in.)

\* See Standards (page 139)

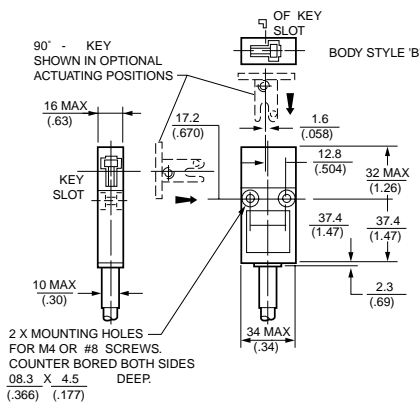

### Body Style

### Cable/Connector

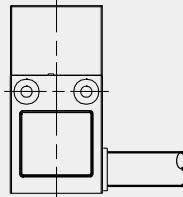

**A**

CABLE LENGTHS IN 1 METRE INCREMENTS

**1**

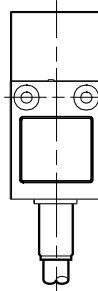

**B**

CABLE SPEC: SJTO RATED P.V.C. TYPE

**2**

3 METRES IS NORMAL MAXIMUM CABLE LENGTH.

**3**

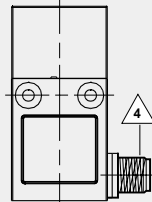

**C**

ZERO INDICATES NO CABLE BUT CONNECTOR

**0**

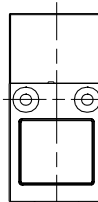

**D**

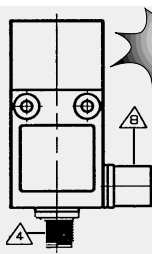
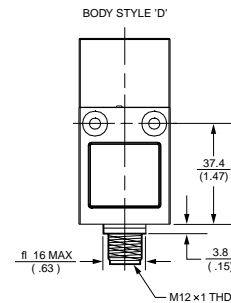

**F**

4 Micro-change DC Style M12, 4 Pin with external threads/male  
8 'F' version also has 4 Pin with internal threads/female

▲ Low Energy Contacts

Note: See page 145

### Ordering:

**GKM**

**X**

**X**

Example: GKMD03W2

**Switch Type**

CONNECTOR PIN-OUTS

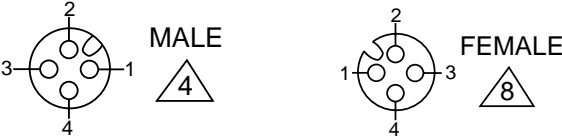

**Key Style**

SLOW-ACTION CONTACTS  
BREAK BEFORE MAKE  
1 NORMALLY CLOSED/1 NORMALLY OPEN

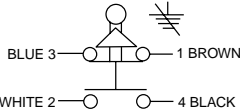
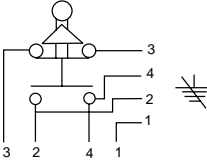

SLOW-ACTION CONTACTS  
BREAK BEFORE MAKE  
1 NORMALLY CLOSED/1 NORMALLY OPEN  
LOW ENERGY CONTACTS



SLOW-ACTION CONTACTS  
2 NORMALLY CLOSED

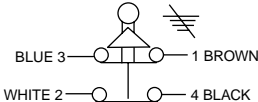
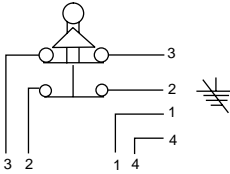

SLOW-ACTION CONTACTS  
2 NORMALLY CLOSED  
LOW ENERGY CONTACTS

Details of straight key (stainless steel)

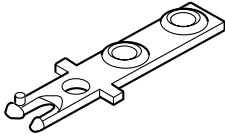

Replacement part number GKZ51M

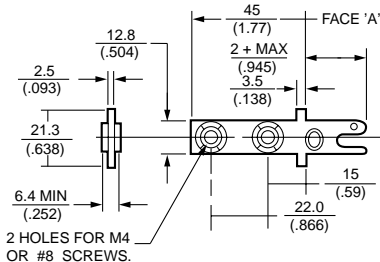

Details of 90° key (stainless steel)

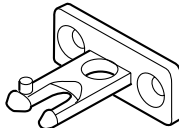

Replacement part number GKZ52M

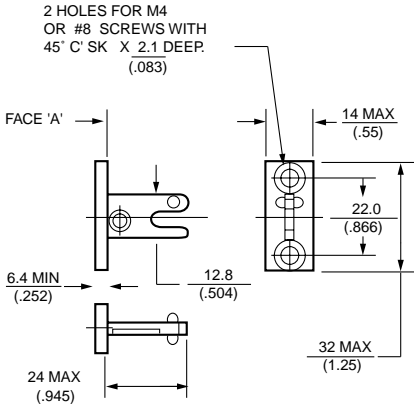

**3**

**9<sup>^</sup>**

**6**

**7<sup>^</sup>**

**W1**

**W2**

**X**

**WX**

Optional Key Positions

GKM

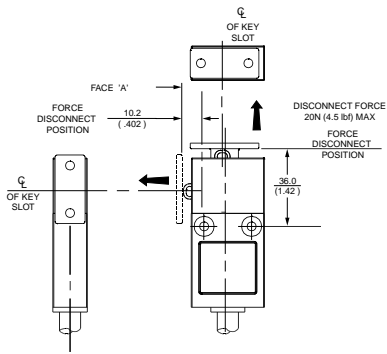

SLOT DUST COVER

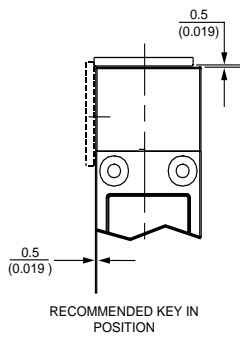
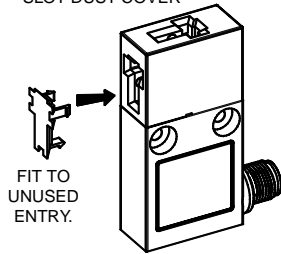

RECOMMENDED KEY IN POSITION