



# SiGe High-Linearity, 1400MHz to 2200MHz Downconversion Mixer with LO Buffer/Switch

MAX9994

## General Description

The MAX9994 high-linearity downconversion mixer provides 8.3dB gain, +26.2dBm IIP3, and 9.7dB NF for 1400MHz to 2200MHz UMTS/WCDMA, DCS, and PCS base-station receiver applications. With a wide LO range of 1400MHz to 2000MHz, the MAX9994 can be used in either high-side or low-side LO injection architectures, depending on the RF band of interest. Higher LO applications are supported by the MAX9996, which is pin-pin and functionally compatible with the MAX9994.

In addition to offering excellent linearity and noise performance, the MAX9994 also yields a high level of component integration. This device includes a double-balanced passive mixer core, an IF amplifier, a dual-input LO selectable switch, and an LO buffer. On-chip baluns are also integrated to allow for single-ended RF and LO inputs. The MAX9994 requires a nominal LO drive of 0dBm, and supply current is guaranteed to be below 235mA.

The MAX9994/MAX9996 are pin compatible with the MAX9984/MAX9986 815MHz to 995MHz mixers, making this entire family of downconverters ideal for applications where a common PC board layout is used for both frequency bands. The MAX9994 is also functionally compatible with the MAX9993.

The MAX9994 is available in a compact, 20-pin, thin QFN package (5mm x 5mm) with an exposed pad. Electrical performance is guaranteed over the extended -40°C to +85°C temperature range.

## Applications

UMTS/LTE Base Stations  
TD-SCDMA/TD-LTE Base Stations  
DCS1800/PCS1900 EDGE Base Stations  
cdmaOne™ and cdma2000® Base Stations  
PHS/PAS Base Stations  
Predistortion Receivers  
Fixed Broadband Wireless Access  
Wireless Local Loop  
Private Mobile Radios  
Military Systems  
Microwave Links  
Digital and Spread-Spectrum Communication Systems

cdma2000 is a registered trademark of Telecommunications Industry Association.

cdmaOne is a trademark of CDMA Development Group.



## Features

- ◆ 1400MHz to 2200MHz RF Frequency Range
- ◆ 1400MHz to 2000MHz LO Frequency Range (MAX9994)
- ◆ 1900MHz to 2400MHz LO Frequency Range (MAX9996)
- ◆ 40MHz to 350MHz IF Frequency Range
- ◆ 8.3dB Conversion Gain
- ◆ +26.2dBm Input IP3
- ◆ +12.6dBm Input 1dB Compression Point
- ◆ 9.7dB Noise Figure
- ◆ 67dBc 2RF - 2LO Spurious Rejection at PRF = -10dBm
- ◆ Integrated LO Buffer
- ◆ Integrated RF and LO Baluns for Single-Ended Inputs
- ◆ Low -3dBm to +3dBm LO Drive
- ◆ Built-In SPDT LO Switch with 45dB LO1 to LO2 Isolation and 50ns Switching Time
- ◆ Pin Compatible with the MAX9984/MAX9986 815MHz to 995MHz Mixers
- ◆ Functionally Compatible with the MAX9993
- ◆ External Current-Setting Resistors Provide Option for Operating Mixer in Reduced Power/Reduced Performance Mode

## Ordering Information

PART	TEMP RANGE	PIN-PACKAGE
MAX9994ETP+	-40°C to +85°C	20 Thin QFN-EP** 5mm x 5mm bulk
MAX9994ETP+T	-40°C to +85°C	20 Thin QFN-EP** 5mm x 5mm T/R

\*\*EP = Exposed pad.

+Denotes a lead(Pb)-free/RoHS-compliant package.

T = Tape and reel.

Pin Configuration/Functional Diagram and Typical Application Circuit appear at end of data sheet.

# SiGe High-Linearity, 1400MHz to 2200MHz Downconversion Mixer with LO Buffer/Switch

## ABSOLUTE MAXIMUM RATINGS

V <sub>CC</sub> to GND	-0.3V to +5.5V	θ <sub>JA</sub> (Note 1)	+38°C/W
IF+, IF-, LOBIAS, LOSEL, IFBIAS to GND	-0.3V to (V <sub>CC</sub> + 0.3V)	θ <sub>JC</sub> (Note 1)	+8°C/W
TAP	-0.3V to +1.4V	Operating Temperature Range (Note 2)	T <sub>C</sub> = -40°C to +85°C
LO1, LO2, LEXT to GND	-0.3V to +0.3V	Junction Temperature	+150°C
RF, LO1, LO2 Input Power	+12dBm	Storage Temperature Range	-65°C to +150°C
RF (RF is DC shorted to GND through a balun)	50mA	Lead Temperature (soldering 10s)	+300°C
Continuous Power Dissipation (T <sub>A</sub> = +70°C)		Soldering Temperature (reflow)	+260°C
20-Pin Thin QFN-EP (derate 20mW/°C above +70°C)	1.8W		

**Note 1:** Package thermal resistances were obtained using the method described in JEDEC specification JESD51-7, using a four-layer board. For detailed information on package thermal considerations, refer to [www.maxim-ic.com/thermal-tutorial](http://www.maxim-ic.com/thermal-tutorial).

**Note 2:** T<sub>C</sub> is the temperature on the exposed pad of the package.

Stresses beyond those listed under "Absolute Maximum Ratings" may cause permanent damage to the device. These are stress ratings only, and functional operation of the device at these or any other conditions beyond those indicated in the operational sections of the specifications is not implied. Exposure to absolute maximum rating conditions for extended periods may affect device reliability.

## DC ELECTRICAL CHARACTERISTICS

(Typical Application Circuit, V<sub>CC</sub> = +4.75V to +5.25V, no RF signal applied, IF+ and IF- outputs pulled up to V<sub>CC</sub> through inductive chokes, R<sub>1</sub> = 806Ω, R<sub>2</sub> = 549Ω, T<sub>C</sub> = -40°C to +85°C, unless otherwise noted. Typical values are at V<sub>CC</sub> = +5V, T<sub>C</sub> = +25°C, unless otherwise noted.)

PARAMETER	SYMBOL	CONDITIONS	MIN	TYP	MAX	UNITS
Supply Voltage	V <sub>CC</sub>		4.75	5.00	5.25	V
Supply Current	I <sub>CC</sub>			206	235	mA
LO_SEL Input Logic-Low	V <sub>IL</sub>				0.8	V
LO_SEL Input Logic-High	V <sub>IH</sub>		2			V

## RECOMMENDED AC OPERATING CONDITIONS

PARAMETER	SYMBOL	CONDITIONS	MIN	TYP	MAX	UNITS
RF Frequency Range	f <sub>RF</sub>	(Note 3)	1400		2200	MHz
LO Frequency Range	f <sub>LO</sub>	(Note 3)	1400		2000	MHz
IF Frequency Range	f <sub>IF</sub>	(Note 3)	40		350	MHz
LO Drive Level	P <sub>LO</sub>	(Note 3)	-3		+3	dBm

# SiGe High-Linearity, 1400MHz to 2200MHz Downconversion Mixer with LO Buffer/Switch

MAX9994

## AC ELECTRICAL CHARACTERISTICS— $f_{RF} = 1700\text{MHz}$ TO $2200\text{MHz}$ , LOW-SIDE LO INJECTION

(Typical Application Circuit,  $V_{CC} = +4.75\text{V}$  to  $+5.25\text{V}$ , RF and LO ports are driven from  $50\Omega$  sources,  $P_{LO} = -3\text{dBm}$  to  $+3\text{dBm}$ ,  $P_{RF} = -5\text{dBm}$ ,  $f_{RF} = 1700\text{MHz}$  to  $2200\text{MHz}$ ,  $f_{LO} = 1400\text{MHz}$  to  $2000\text{MHz}$ ,  $f_{IF} = 200\text{MHz}$ ,  $f_{RF} > f_{LO}$ ,  $T_C = -40^\circ\text{C}$  to  $+85^\circ\text{C}$ , unless otherwise noted. Typical values are at  $V_{CC} = +5\text{V}$ ,  $P_{RF} = -5\text{dBm}$ ,  $P_{LO} = 0\text{dBm}$ ,  $f_{RF} = 1900\text{MHz}$ ,  $f_{LO} = 1700\text{MHz}$ ,  $f_{IF} = 200\text{MHz}$ ,  $T_C = +25^\circ\text{C}$ , unless otherwise noted.) (Notes 4, 5)

PARAMETER	SYMBOL	CONDITIONS		MIN	TYP	MAX	UNITS
Conversion Gain	GC	$P_{RF} < +2\text{dBm}$ , $T_A = +25^\circ\text{C}$ (Note 6)		7.2	8.3	9.2	dB
Gain Variation Over Temperature		$T_C = -40^\circ\text{C}$ to $+85^\circ\text{C}$			$\pm 0.75$		dB
Input Compression Point	$P_{1\text{dB}}$	(Note 7)			12.6		dBm
Input Third-Order Intercept Point (Note 6)	IIP3	Two tones: $f_{RF1} = 2000\text{MHz}$ , $f_{RF2} = 2001\text{MHz}$ , $P_{RF} = -5\text{dBm}/\text{tone}$ , $f_{LO} = 1800\text{MHz}$ , $P_{LO} = 0\text{dBm}$ , $T_A = +25^\circ\text{C}$		23.5	26.2		dBm
Input IP3 Variation Over Temperature		$T_C = -40^\circ\text{C}$ to $+85^\circ\text{C}$			$\pm 0.5$		dB
Noise Figure	NF	Single sideband			9.7		dB
Noise Figure Under-Blocking		$P_{RF} = 5\text{dBm}$ , $f_{RF} = 2000\text{MHz}$ , $f_{LO} = 1810\text{MHz}$ , $f_{\text{block}} = 2100\text{MHz}$ (Note 8)			19		dB
LO Drive				-3		+3	dBm
Spurious Response at IF	2 x 2	2RF - 2LO	$P_{RF} = -10\text{dBm}$		67		dBc
			$P_{RF} = -5\text{dBm}$		62		
	3 x 3	3RF - 3LO	$P_{RF} = -10\text{dBm}$		82		
			$P_{RF} = -5\text{dBm}$		72		
LO1 to LO2 Isolation (Note 4)		LO2 selected, $1500\text{MHz} < f_{LO} < 1700\text{MHz}$		40	52		dB
		LO1 selected, $1500\text{MHz} < f_{LO} < 1700\text{MHz}$		40	45		
Maximum LO Leakage at RF Port		$P_{LO} = +3\text{dBm}$			-17		dBm
Maximum LO Leakage at IF Port		$P_{LO} = +3\text{dBm}$			-30		dBm
Minimum RF-to-IF Isolation					35		dB
LO Switching Time		50% of LOSEL to IF settled to within $2^\circ$			50		ns
RF Port Return Loss					21		dB
LO Port Return Loss		LO1/2 port selected, LO2/1 and IF terminated			16		dB
		LO1/2 port unselected, LO2/1 and IF terminated			26		
IF Port Return Loss		LO driven at $0\text{dBm}$ , RF terminated into $50\Omega$ , differential $200\Omega$			20		dB

# SiGe High-Linearity, 1400MHz to 2200MHz Downconversion Mixer with LO Buffer/Switch

## AC ELECTRICAL CHARACTERISTICS— $f_{RF} = 1455\text{MHz}$ , HIGH-SIDE LO INJECTION

(Typical Application Circuit, RF and LO ports are driven from  $50\Omega$  sources,  $f_{RF} < f_{LO}$ ,  $V_{CC} = +5\text{V}$ ,  $P_{RF} = -5\text{dBm}$ ,  $P_{LO} = 0\text{dBm}$ ,  $f_{RF} = 1455\text{MHz}$ ,  $f_{LO} = 1625\text{MHz}$ ,  $f_{IF} = 170\text{MHz}$ ,  $T_C = +25^\circ\text{C}$ , LO2 is selected, unless otherwise noted.) (Note 5)

PARAMETER	SYMBOL	CONDITIONS	MIN	TYP	MAX	UNITS
Conversion Gain	$G_C$			8.8		dB
Input Third-Order Intercept Point	IIP3	Two tones: $f_{RF1} = 1455\text{MHz}$ , $f_{RF2} = 1456\text{MHz}$ , $P_{RF} = -5\text{dBm/ tone}$		25.6		dBm
Input Compression Point (Note 7)	IP <sub>1dB</sub>			12.7		dBm
2LO - 2RF Spurious Response	2 x 2	$P_{RF} = -10\text{dBm}$		71.4		dBc
		$P_{RF} = -5\text{dBm}$		66.4		
LO-to-IF Leakage		LOSEL = LO2		-30.2		dBm

## AC ELECTRICAL CHARACTERISTICS— $f_{RF} = 1500\text{MHz}$ , HIGH-SIDE LO INJECTION

(Typical Application Circuit, RF and LO ports are driven from  $50\Omega$  sources,  $f_{RF} < f_{LO}$ ,  $V_{CC} = +5\text{V}$ ,  $P_{RF} = -5\text{dBm}$ ,  $P_{LO} = 0\text{dBm}$ ,  $f_{RF} = 1500\text{MHz}$ ,  $f_{LO} = 1650\text{MHz}$ ,  $f_{IF} = 150\text{MHz}$ ,  $T_C = +25^\circ\text{C}$ , LO1 is selected, unless otherwise noted.) (Note 5)

PARAMETER	SYMBOL	CONDITIONS	MIN	TYP	MAX	UNITS
Conversion Gain	$G_C$			8.9		dB
Input Third-Order Intercept Point	IIP3	Two tones: $f_{RF1} = 1500\text{MHz}$ , $f_{RF2} = 1501\text{MHz}$ , $P_{RF} = -5\text{dBm/ tone}$		25.5		dBm
Input Compression Point (Note 7)	IP <sub>1dB</sub>			12.5		dBm
2LO - 2RF Spurious Response	2 x 2	$P_{RF} = -10\text{dBm}$		70.4		dBc
		$P_{RF} = -5\text{dBm}$		65.4		
LO-to-IF Leakage				-33.2		dBm

**Note 3:** Operation outside this range is possible, but with degraded performance of some parameters.

**Note 4:** Guaranteed by design and characterization.

**Note 5:** All limits include external component losses. Output measurements taken at IF output of the Typical Application Circuit.

**Note 6:** Production tested.

**Note 7:** Compression point characterized. It is advisable not to operate continuously the mixer RF input above +12dBm.

**Note 8:** Measured with external LO source noise filtered so the noise floor is -174dBm/Hz. This specification reflects the effects of all SNR degradations in the mixer, including the LO noise as defined in Application Note 2021: *Specifications and Measurement of Local Oscillator Noise in Integrated Circuit Base Station Mixers*.

# SiGe High-Linearity, 1400MHz to 2200MHz Downconversion Mixer with LO Buffer/Switch

MAX9994

## Typical Operating Characteristics

(MAX9994 Typical Application Circuit,  $V_{CC} = +5.0V$ ,  $P_{LO} = 0dBm$ ,  $PRF = -5dBm$ ,  $f_{RF} = 1700MHz$  to  $2200MHz$ , LO is Low-Side Injected for a 200MHz IF, unless otherwise noted.)

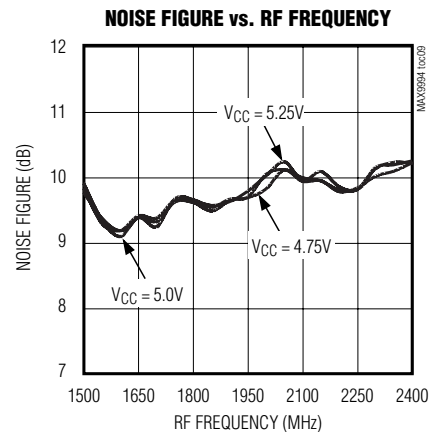
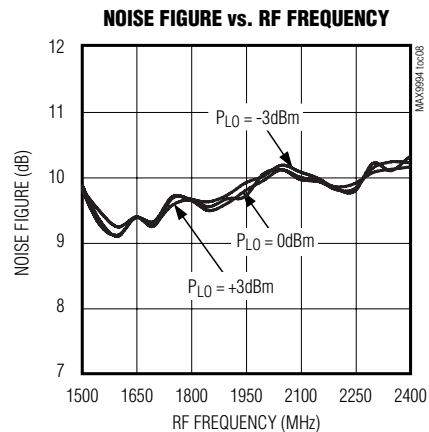
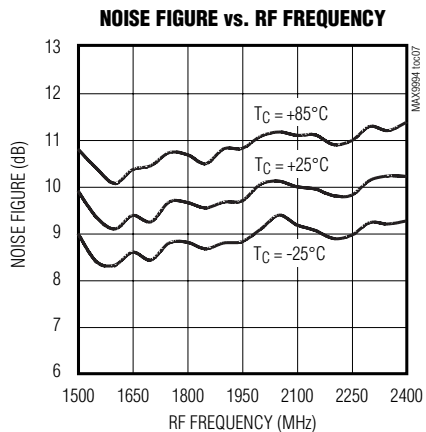
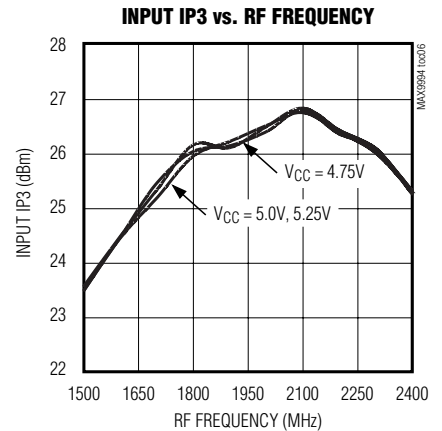
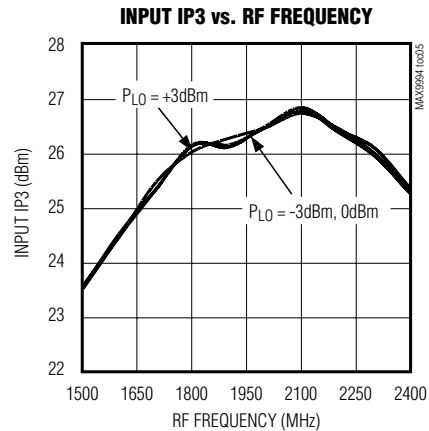
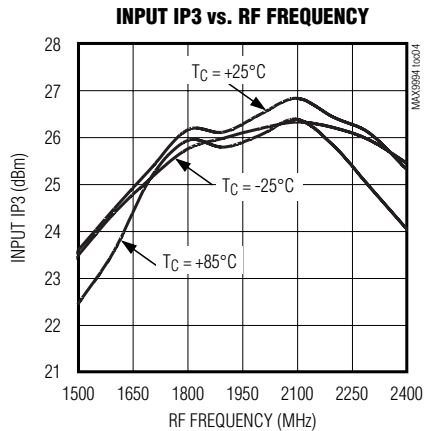
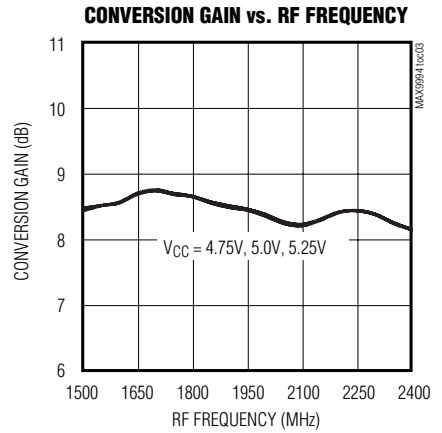
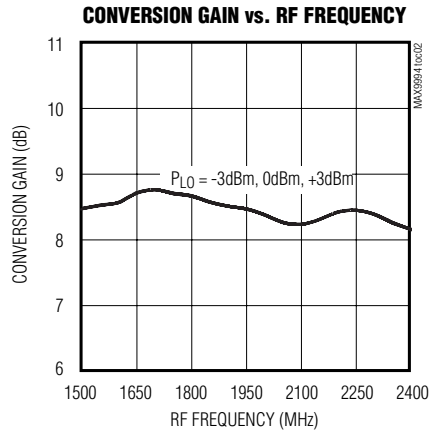
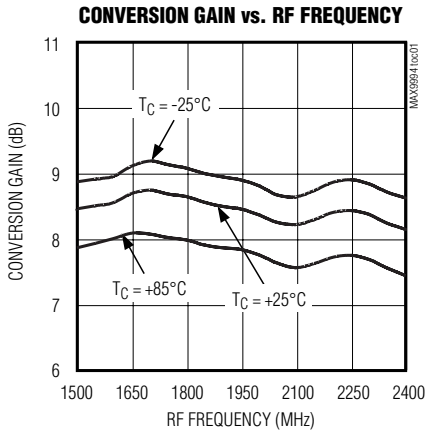

# SiGe High-Linearity, 1400MHz to 2200MHz Downconversion Mixer with LO Buffer/Switch

## Typical Operating Characteristics (continued)

(MAX9994 Typical Application Circuit,  $V_{CC} = +5.0V$ ,  $P_{LO} = 0dBm$ ,  $P_{RF} = -5dBm$ ,  $f_{RF} = 1700MHz$  to  $2200MHz$ , LO is Low-Side Injected for a 200MHz IF, unless otherwise noted.)

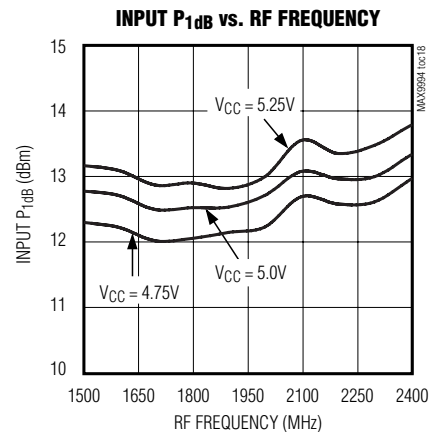
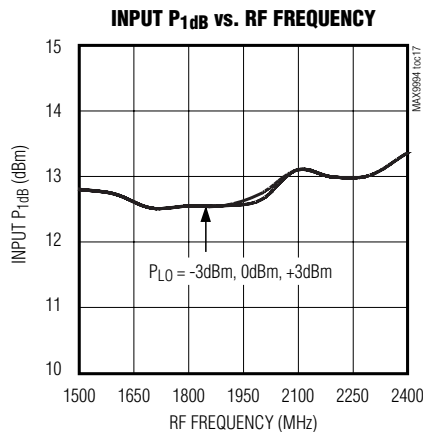
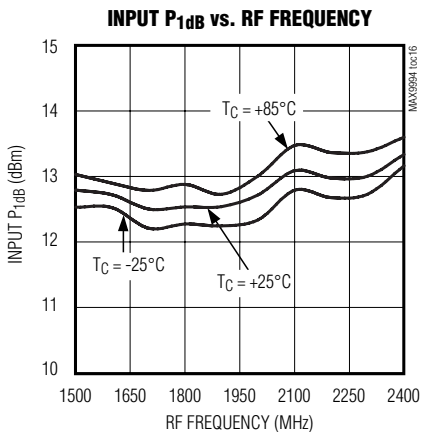
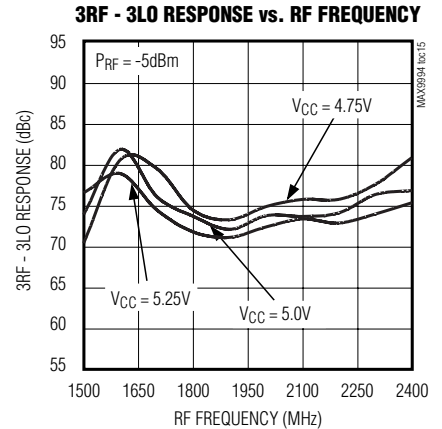
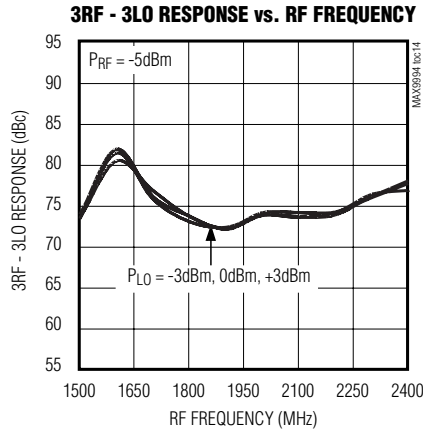
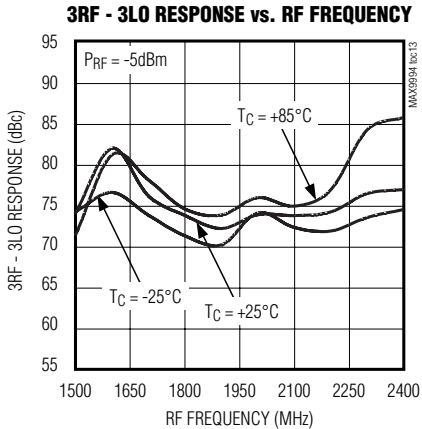
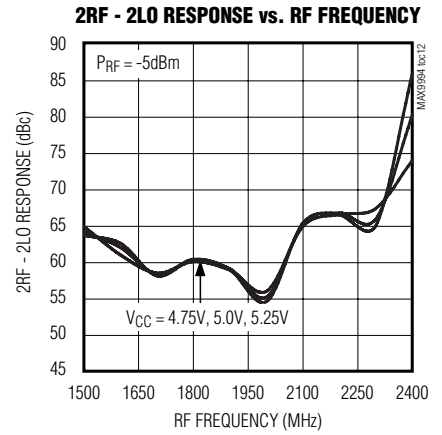
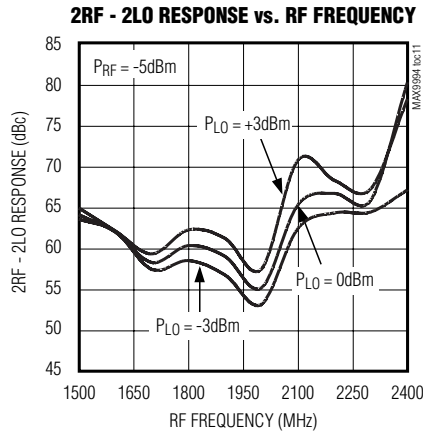
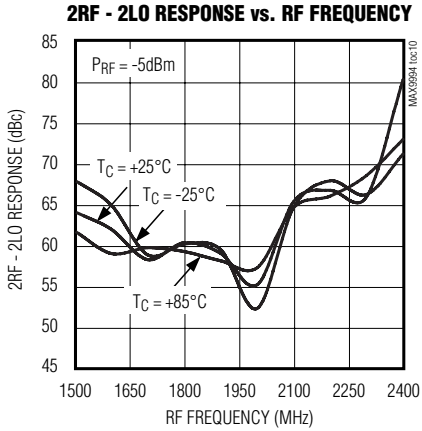

# SiGe High-Linearity, 1400MHz to 2200MHz Downconversion Mixer with LO Buffer/Switch

MAX9994

## Typical Operating Characteristics (continued)

(MAX9994 Typical Application Circuit,  $V_{CC} = +5.0V$ ,  $P_{LO} = 0dBm$ ,  $PRF = -5dBm$ ,  $f_{RF} = 1700MHz$  to  $2200MHz$ , LO is Low-Side Injected for a 200MHz IF, unless otherwise noted.)

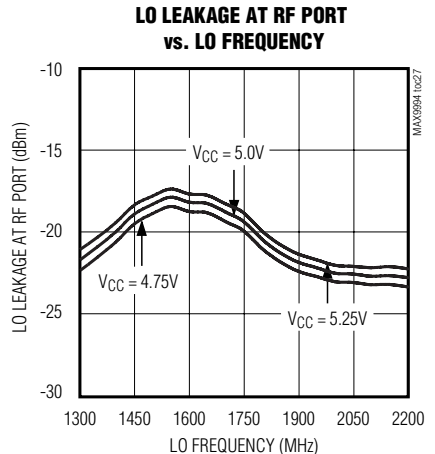
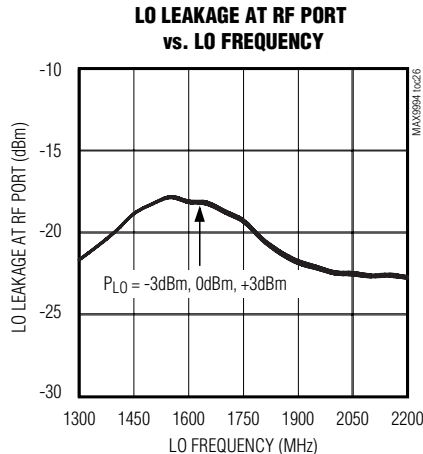
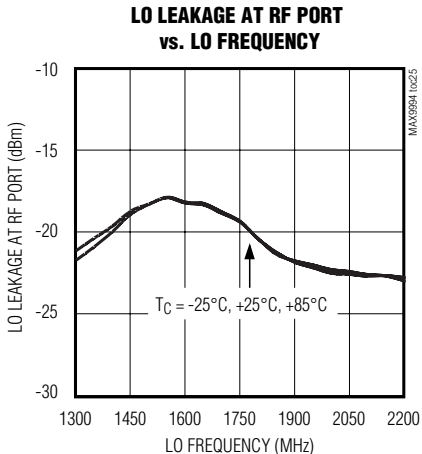
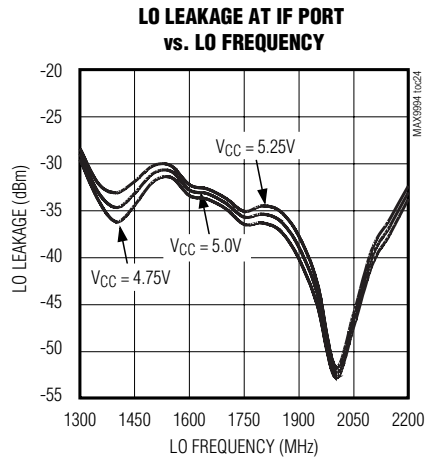
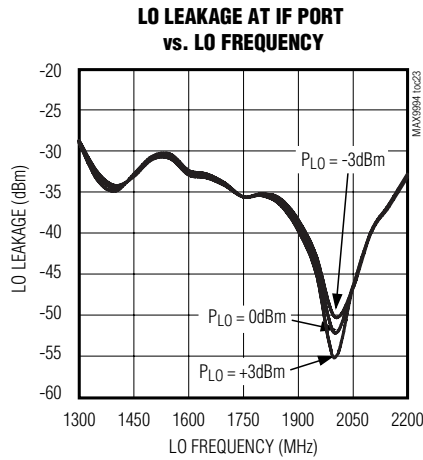
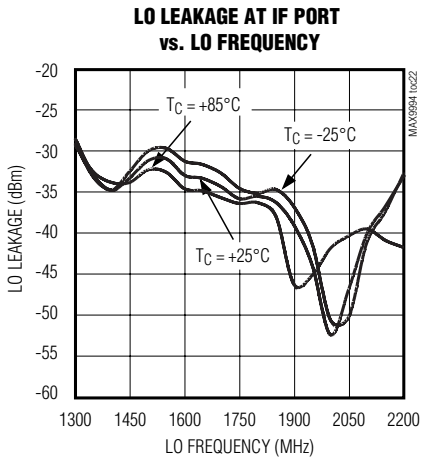
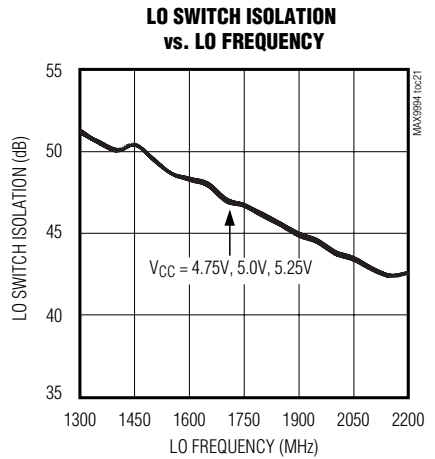
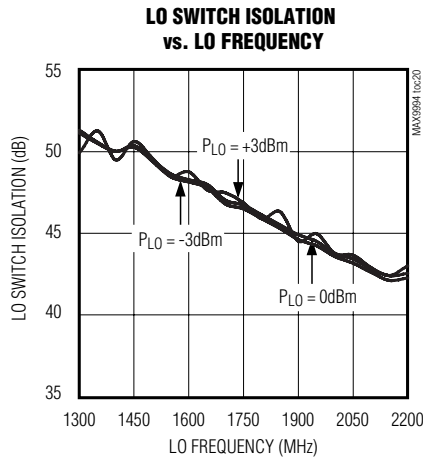
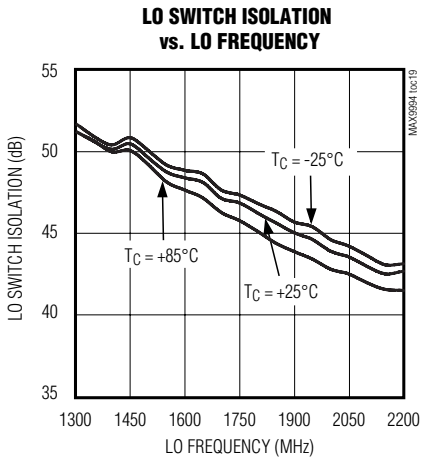

# SiGe High-Linearity, 1400MHz to 2200MHz Downconversion Mixer with LO Buffer/Switch

## Typical Operating Characteristics (continued)

(MAX9994 Typical Application Circuit,  $V_{CC} = +5.0V$ ,  $P_{LO} = 0dBm$ ,  $PRF = -5dBm$ ,  $f_{RF} = 1700MHz$  to  $2200MHz$ , LO is Low-Side Injected for a 200MHz IF, unless otherwise noted.)

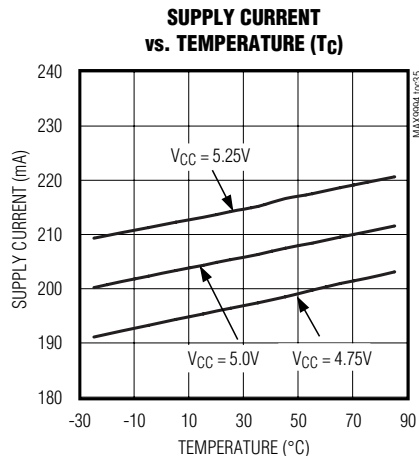
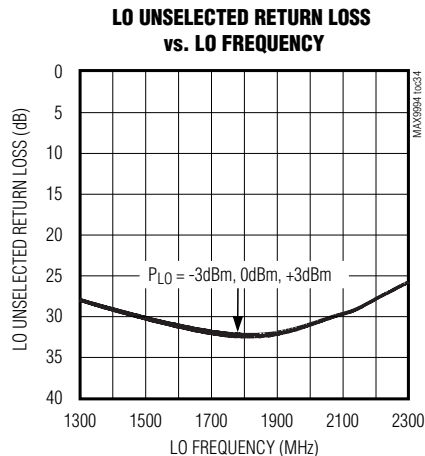
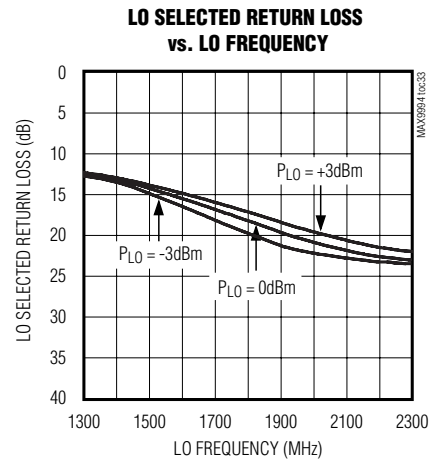
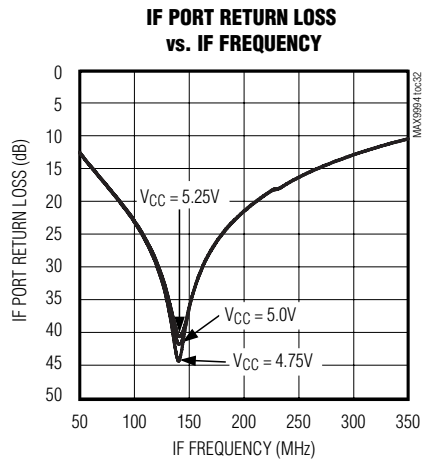
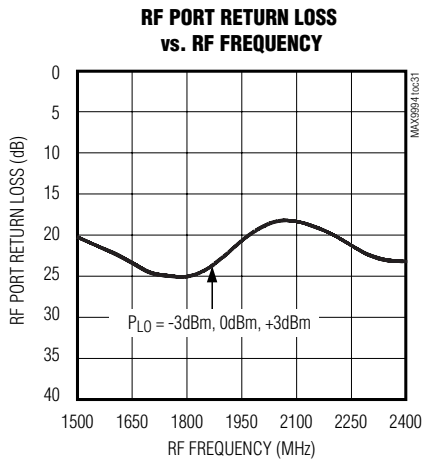
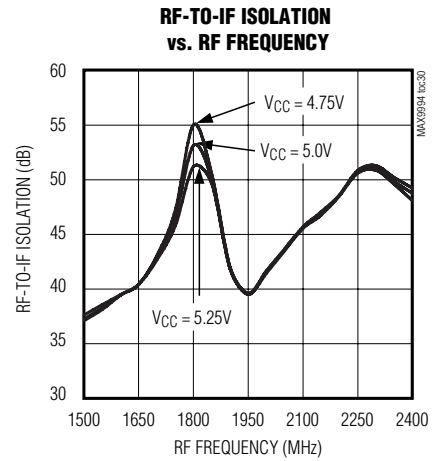
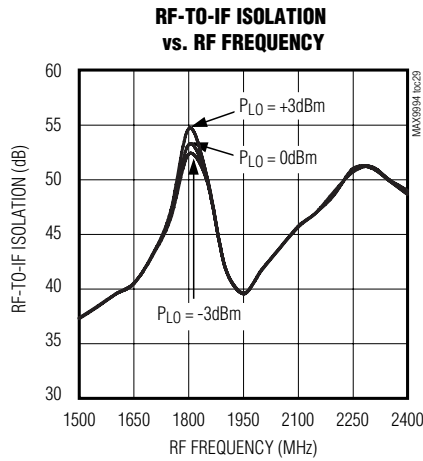
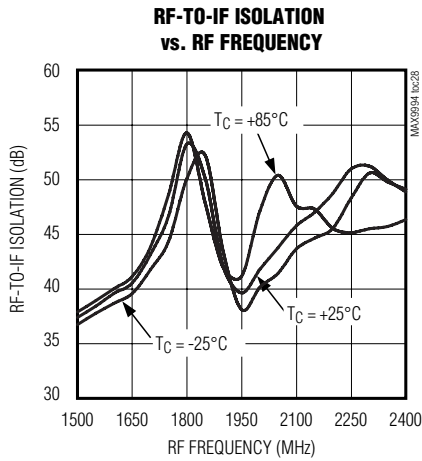



# SiGe High-Linearity, 1400MHz to 2200MHz Downconversion Mixer with LO Buffer/Switch

MAX9994

## Typical Operating Characteristics (continued)

(MAX9994 Typical Application Circuit,  $V_{CC} = +5V$ ,  $P_{LO} = 0dBm$ , LO2 selected,  $P_{RF} = -5dBm$ ,  $f_{RF} = 1400MHz$  to  $1700MHz$ , LO is High-Side Injected for a 170MHz IF, unless otherwise noted.)

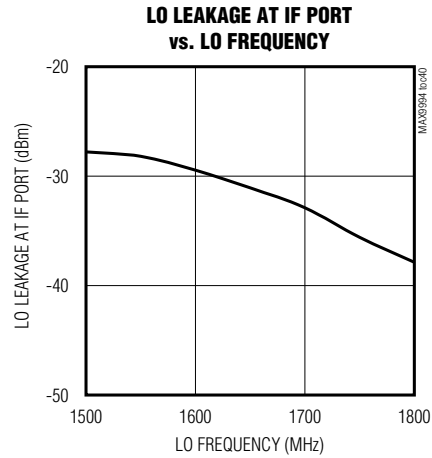
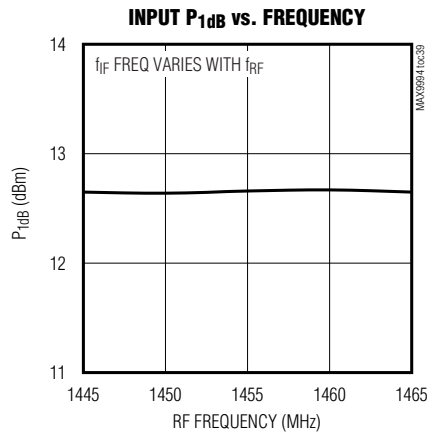
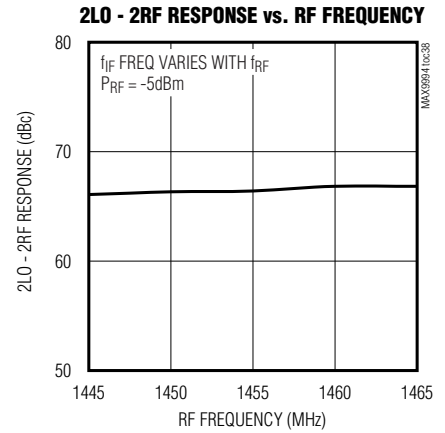
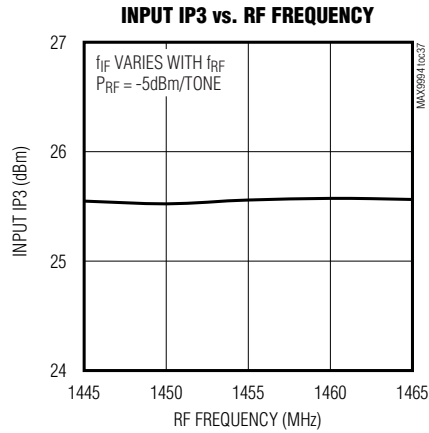
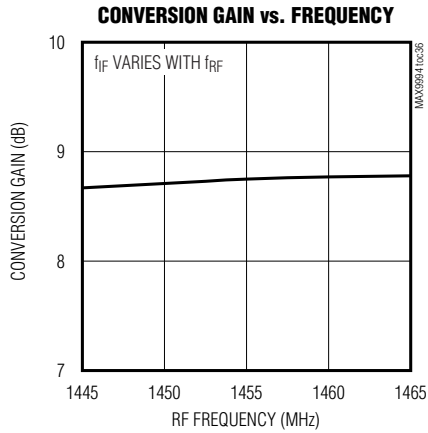

# SiGe High-Linearity, 1400MHz to 2200MHz Downconversion Mixer with LO Buffer/Switch

## Typical Operating Characteristics (continued)

(MAX9994 Typical Application Circuit,  $V_{CC} = +5V$ ,  $P_{LO} = 0dBm$ , LO1 selected,  $P_{RF} = -5dBm$ ,  $f_{RF} = 1400MHz$  to  $1700MHz$ , LO is High-Side Injected for a 150MHz IF, unless otherwise noted.)

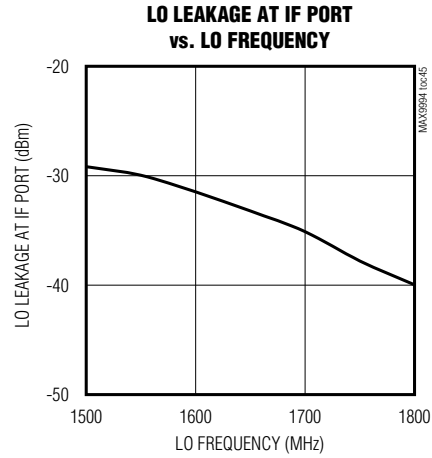
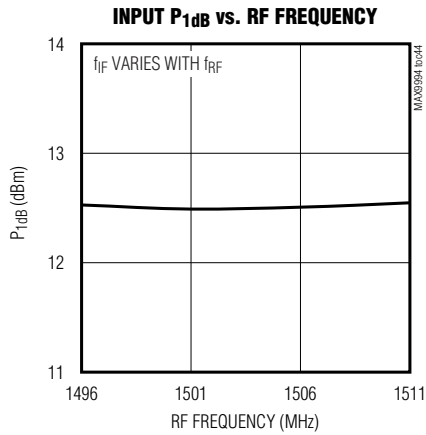
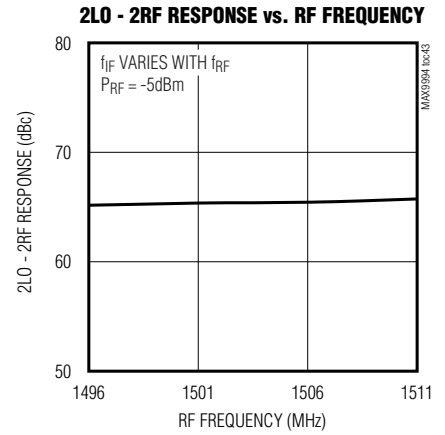
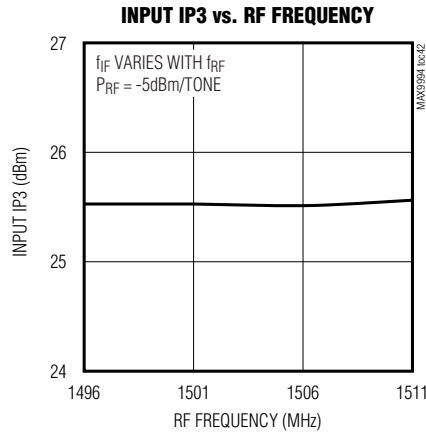
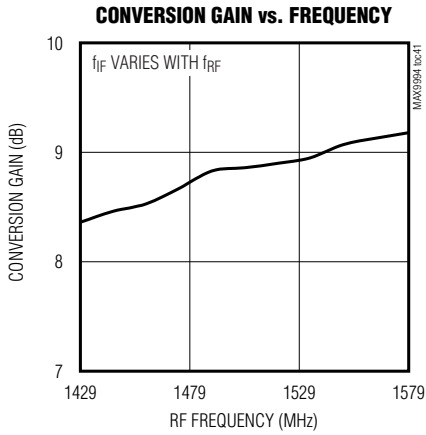

# SiGe High-Linearity, 1400MHz to 2200MHz Downconversion Mixer with LO Buffer/Switch

MAX9994

## Pin Description

PIN	NAME	FUNCTION
1, 6, 8, 14	VCC	Power-Supply Connection. Bypass each VCC pin to GND with capacitors as shown in the <i>Typical Application Circuit</i> .
2	RF	Single-Ended 50Ω RF Input. This port is internally matched and DC shorted to GND through a balun. Requires an external DC-blocking capacitor.
3	TAP	Center Tap of the Internal RF Balun. Bypass to GND with capacitors close to the IC, as shown in the <i>Typical Application Circuit</i> .
4, 5, 10, 12, 13, 17	GND	Ground
7	LOBIAS	Bias Resistor for Internal LO Buffer. Connect a 549Ω ±1% resistor from LOBIAS to the power supply.
9	LOSEL	Local Oscillator Select. Logic control input for selecting LO1 or LO2.
11	LO1	Local Oscillator Input 1. Drive LOSEL low to select LO1.
15	LO2	Local Oscillator Input 2. Drive LOSEL high to select LO2.
16	LEXT	External Inductor Connection. Connect a low-ESR, 10nH inductor from LEXT to GND. This inductor carries approximately 100mA DC current.
18, 19	IF-, IF+	Differential IF Outputs. Each output requires external bias to VCC through an RF choke (see the <i>Typical Application Circuit</i> ).
20	IFBIAS	IF Bias Resistor Connection for IF Amplifier. Connect an 806Ω resistor from IFBIAS to GND.
—	EP	Exposed Pad. Solder the exposed pad to the ground plane using multiple vias.

## Detailed Description

The MAX9994 high-linearity downconversion mixer provides 8.3dB of conversion gain and 26.2dBm of IIP3, with a typical 9.7dB noise figure. The integrated baluns and matching circuitry allow for 50Ω single-ended interfaces to the RF and the two LO ports. A single-pole, double-throw (SPDT) switch provides 50ns switching time between the two LO inputs with 45dB of LO-to-LO isolation. Furthermore, the integrated LO buffer provides a high drive level to the mixer core, reducing the LO drive required at the MAX9994's inputs to a range of -3dBm to +3dBm. The IF port incorporates a differential output, which is ideal for providing enhanced IIP2 performance.

Specifications are guaranteed over broad frequency ranges to allow for use in WCDMA, TD-SCDMA, LTE, TD-LTE, cdma2000, and 2G/2.5G/3G DCS1800 and PCS1900 base stations. The MAX9994 is specified to operate over a 1400MHz to 2200MHz RF frequency range, a 1400MHz to 2000MHz LO frequency range, and a 40MHz to 350MHz IF frequency range. Operation beyond these ranges is possible; see the *Typical Operating Characteristics* for additional details.

With a wide LO range of 1400MHz to 2000MHz, the MAX9994 can be used in either high-side or low-side LO injection architectures, depending on the RF band of interest. Higher LO applications are supported by the MAX9996, which is pin-pin and functionally compatible with the MAX9994.

### RF Input and Balun

The MAX9994 RF input is internally matched to 50Ω, requiring no external matching components. A DC-blocking capacitor is required because the input is internally DC shorted to ground through the on-chip balun. Input return loss is typically 21dB over the entire 1700MHz to 2200MHz RF frequency range.

### LO Inputs, Buffer, and Balun

The MAX9994 can be used for either high-side or low-side injection applications with a 1400MHz to 2000MHz LO frequency range. For a device with a 1900MHz to 2400MHz LO frequency range, refer to the MAX9996 data sheet. As an added feature, the MAX9994 includes an internal LO SPDT switch that can be used for frequency-hopping applications. The switch selects one of the two single-ended LO ports, allowing the external oscillator to settle on a particular frequency before it is

# SiGe High-Linearity, 1400MHz to 2200MHz Downconversion Mixer with LO Buffer/Switch

switched in. LO switching time is typically less than 50ns, which is more than adequate for virtually all GSM applications. If frequency hopping is not employed, set the switch to either of the LO inputs. The switch is controlled by a digital input (LOSEL): logic-high selects LO2, logic-low selects LO1. LO1 and LO2 inputs are internally matched to 50Ω, requiring only a 22pF DC blocking capacitor.

A two-stage internal LO buffer allows a wide input power range for the LO drive. All guaranteed specifications are for an LO signal power from -3dBm to +3dBm. The on-chip low-loss balun, along with an LO buffer, drives the double-balanced mixer. All interfacing and matching components from the LO inputs to the IF outputs are integrated on-chip.

## High-Linearity Mixer

The core of the MAX9994 is a double-balanced, high-performance passive mixer. Exceptional linearity is provided by the large LO swing from the on-chip LO buffer. When combined with the integrated IF amplifiers, the cascaded IIP3, 2RF - 2LO rejection, and NF performance is typically 26.2dBm, 67dBc, and 9.7dB, respectively.

## Differential IF Output Amplifier

The MAX9994 mixer has a 40MHz to 350MHz IF frequency range. The differential, open-collector IF output ports require external pullup inductors to VCC. Note that these differential outputs are ideal for providing enhanced 2RF - 2LO rejection performance. Single-ended IF applications require a 4:1 balun to transform the 200Ω differential output impedance to a 50Ω single-ended output. After the balun, the IF return loss is better than 15dB.

## Applications Information

### Input and Output Matching

The RF and LO inputs are internally matched to 50Ω. No matching components are required. Return loss at the RF port is typically 21dB over the 1700MHz to 2200MHz input range, and the return loss at the LO port is typically better than 14dB (1400MHz to 2000MHz). RF and LO inputs require only DC-blocking capacitors for interfacing.

The IF output impedance is 200Ω (differential). For evaluation, an external low-loss 4:1 (impedance ratio) balun transforms this impedance down to a 50Ω single-ended output (see the *Typical Application Circuit*).

## Bias Resistors

Bias currents for the LO buffer and the IF amplifier are optimized by fine tuning resistors R1 and R2. If reduced current is required at the expense of performance, contact the factory for details. If the ±1% bias resistor values are not readily available, substitute standard ±5% values.

## LEXT Inductor

Short LEXT to ground using a 0Ω resistor. For applications requiring improved RF-to-IF and LO-to-IF isolation, a 10nH inductor (L3) can be used in place of the 0Ω resistor. However, in order to ensure stable operation, the mixer IF ports must be presented with a low common-mode load impedance. Contact the factory for details. Since approximately 100mA flows through LEXT, it is important to use a low-DCR wire-wound inductor.

## Layout Considerations

A properly designed PC board is an essential part of any RF/microwave circuit. Keep RF signal lines as short as possible to reduce losses, radiation, and inductance. For the best performance, route the ground pin traces directly to the exposed pad under the package. The PC board exposed pad **MUST** be connected to the ground plane of the PC board. It is suggested that multiple vias be used to connect this pad to the lower level ground planes. This method provides a good RF/thermal conduction path for the device. Solder the exposed pad on the bottom of the device package to the PC board. The MAX9994 evaluation kit can be used as a reference for board layout. Gerber files are available upon request at [www.maxim-ic.com](http://www.maxim-ic.com).

## Power-Supply Bypassing

Proper voltage-supply bypassing is essential for high-frequency circuit stability. Bypass each VCC pin and TAP with the capacitors shown in the *Typical Application Circuit*; see Table 1. Place the TAP bypass capacitor to ground within 100 mils of the TAP pin.

## Exposed Pad RF/Thermal Considerations

The exposed pad (EP) of the MAX9994's 20-pin thin QFN-EP package provides a low thermal-resistance path to the die. It is important that the PCB on which the MAX9994 is mounted be designed to conduct heat from the EP. In addition, provide the EP with a low-inductance path to electrical ground. The EP **MUST** be soldered to a ground plane on the PCB, either directly or through an array of plated via holes.

# SiGe High-Linearity, 1400MHz to 2200MHz Downconversion Mixer with LO Buffer/Switch

MAX9994

Table 1. Component List Referring to the Typical Application Circuit

COMPONENT	VALUE	DESCRIPTION
C1	4pF	Microwave capacitor (0603)
C2, C6, C7, C8, C10, C12	22pF	Microwave capacitors (0603)
C3, C5, C9, C11	0.01μF	Microwave capacitors (0603)
C4	10pF	Microwave capacitor (0603)
C13, C14	150pF	Microwave capacitors (0603)
C15	150pF	Microwave capacitor (0402)
L1, L2	470nH	Wire-wound high-Q inductors (0805)
L3	10nH	Wire-wound high-Q inductor (0603)
R1	806Ω	±1% resistor (0603)
R2	549Ω	±1% resistor (0603)
R3	7.15Ω	±1% resistor (1206)
T1	4:1 balun	IF balun
U1	MAX9994	Maxim IC

## Pin Configuration/Functional Diagram

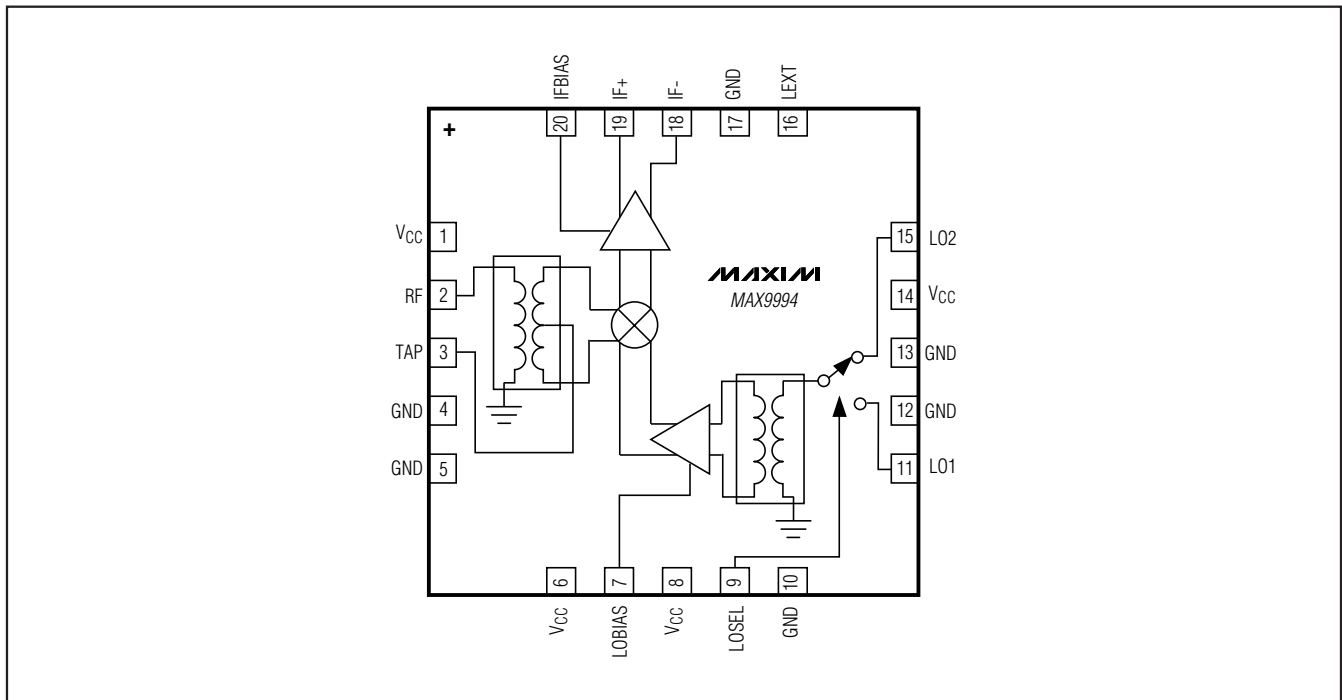

# SiGe High-Linearity, 1400MHz to 2200MHz Downconversion Mixer with LO Buffer/Switch

## Typical Application Circuit

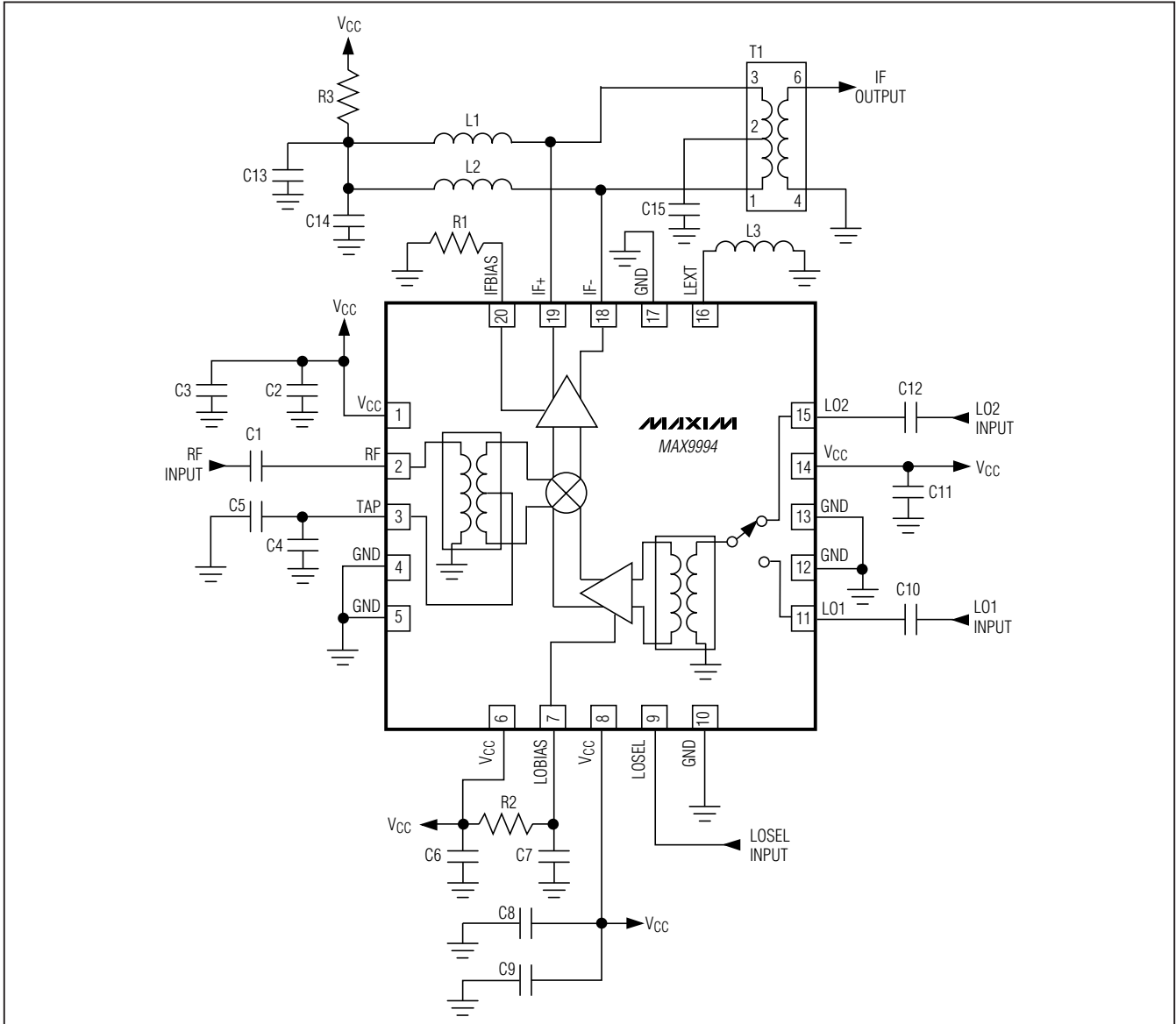

### Chip Information

PROCESS: SiGe BiCMOS

### Package Information

For the latest package outline information and land patterns, go to [www.maxim-ic.com/packages](http://www.maxim-ic.com/packages). Note that a "+", "#", or "-" in the package code indicates RoHS status only. Package drawings may show a different suffix character, but the drawing pertains to the package regardless of RoHS status.

PACKAGE TYPE	PACKAGE CODE	OUTLINE NO.	LAND PATTERN NO.
20 TQFN-EP	T2055+3	<a href="#">21-0140</a>	<a href="#">90-0008</a>

# SiGe High-Linearity, 1400MHz to 2200MHz Downconversion Mixer with LO Buffer/Switch

## Revision History

REVISION NUMBER	REVISION DATE	DESCRIPTION	PAGES CHANGED
0	10/04	Initial release	—
1	12/10	Updated Title, General Description, Ordering Information, Absolute Maximum Ratings, Electrical Characteristics, Typical Operating Characteristics, Pin Description, General Description, and Applications Information sections	1-12

MAX9994

Maxim cannot assume responsibility for use of any circuitry other than circuitry entirely embodied in a Maxim product. No circuit patent licenses are implied. Maxim reserves the right to change the circuitry and specifications without notice at any time.

Maxim Integrated Products, 120 San Gabriel Drive, Sunnyvale, CA 94086 408-737-7600 \_\_\_\_\_ 15

# Mouser Electronics

Authorized Distributor

Click to View Pricing, Inventory, Delivery & Lifecycle Information:

[Analog Devices Inc.:](#)

[MAX9994ETP](#) [MAX9994ETP-T](#)