

T-41-33
T-41-31
T-41-35

Specifications

Part No.	Description	Voltage (V)	Current Per Segment (mA)	Average Brightness (Ft/L)	Milli-candela (MCD)	Character (in)		Package Dimensions (in)			Remarks
						Height	Width	H	W	D	

Theoretical life for each display is 100K hours

KW-100

KW-104S	Digit	4	15 ± 2	13,000	44 ± 8	.300	.155	.468	.306	.312	7 Segment
KW-104S-NS	North/South	4	15 ± 2	13,000	44 ± 8	.300	.155	.468	.306	.312	7 Segment
KW-104S-EW	East/West	4	15 ± 2	13,000	55 ± 10	.300	.155	.468	.306	.312	9 Segment
KW-104S-LR	Left/Right	4	15 ± 2	13,000	44 ± 8	.300	.155	.468	.306	.312	7 Segment
KW-104S-XY	X/Y	4	15 ± 2	13,000	25 ± 6	.300	.155	.468	.306	.312	4 Segment
KW-104S-PM	Plus/Minus	4	15 ± 2	13,000	13 ± 3	.155	.155	.468	.306	.312	2 Segment
KW-104S-DP	Decimal Point	4	13 ± 2	13,000	3.5 ± 1.7	N/A	N/A	.468	.100	.312	1 Segment
KW-104S-CL	Colon	4	13 ± 2	13,000	7 ± 3.4	N/A	N/A	.468	.100	.312	2 Segment
KW-104S-L1	Numeric 1	4	15 ± 2	13,000	13 ± 3	.300	N/A	.468	.100	.312	2 Segment
KW-104AL	Alphanumeric	4	15 ± 2	13,000	90 ± 20	.300	.200	.468	.375	.312	16 Segment
KW-104S-TB	Digit	4	15 ± 2	13,000	44 ± 8	.300	.200	.468	.306	.312	7 Segment
KW-104S-DP-TB	Decimal Point	4	13 ± 2	13,000	3.5 ± 1.7	N/A	N/A	.468	.100	.312	1 Segment
KW-104S-CL-TB	Colon	4	13 ± 2	13,000	7 ± 3.4	N/A	N/A	.468	.100	.312	2 Segment
KW-104S-L1-TB	Numeric 1	4	15 ± 2	13,000	13 ± 3	.300	N/A	.468	.100	.312	2 Segment
KW-104G-H	Digit	4	15 ± 2	13,000	44 ± 8	.300	.155	.468	.306	.312	7 Segment
KW-114G	Digit with D.P.	4	15 ± 2	13,000	44 ± 8*	.300	.155	.605	.306	.185	7 Seg. with D.P.
KW-104G-AL	Alphanumeric	4	15 ± 2	13,000	90 ± 20	.300	.200	.468	.375	.185	16 Segment
KW-104G-AL-DIP	Alphanumeric	4	15 ± 2	13,000	90 ± 20	.300	.200	.626	.375	.185	16 Segment
KW-104G-DIP	Digit	4	15 ± 2	13,000	44 ± 8	.300	.155	.740	.400	.270	7 Segment
KW-114G-DIP	Digit with D.P.	4	15 ± 2	13,000	44 ± 8*	.300	.155	.740	.400	.270	7 Seg. with D.P.
KW-134G-DIP	Digit with Colon	4	15 ± 2	13,000	44 ± 8*	.300	.155	.740	.400	.270	7 Seg. with Colon
KW-104RG	Digit	4	15 ± 2	13,000	44 ± 8	.300	.155	.468	.306	.937	7 Segment
KW-104AL-RG	Alphanumeric	4	15 ± 2	13,000	90 ± 20	.300	.200	.468	.375	1.138	16 Segment
KWD-104AL-RG	Alphanumeric	4	15 ± 2	13,000	90 ± 20	.300	.200	.468	.375	1.138	16 Seg. with Diode
KW-105S	Digit	5	15 ± 2	13,000	52.5 ± 9.5	.300	.155	.468	.306	.312	7 Segment
KW-105S-NS	North/South	5	15 ± 2	13,000	52.5 ± 9.5	.300	.155	.468	.306	.312	7 Segment
KW-105S-EW	East/West	5	15 ± 2	13,000	67 ± 13	.300	.155	.468	.306	.312	9 Segment
KW-105S-LR	Left/Right	5	15 ± 2	13,000	52.5 ± 9.5	.300	.155	.468	.306	.312	7 Segment
KW-105S-XY	X/Y	5	15 ± 2	13,000	30 ± 6	.300	.155	.468	.306	.312	4 Segment
KW-105S-PM	Plus/Minus	5	15 ± 2	13,000	15 ± 3	.155	.155	.468	.306	.312	2 Segment
KW-105S-DP	Decimal Point	5	13 ± 2	13,000	4.2 ± 2.0	N/A	N/A	.468	.100	.312	1 Segment
KW-105S-CL	Colon	5	13 ± 2	13,000	8.4 ± 4.0	N/A	N/A	.468	.100	.312	2 Segment
KW-105S-L1	Numeric 1	5	15 ± 2	13,000	15 ± 3	.300	N/A	.468	.100	.312	2 Segment
KW-105AL	Alphanumeric	5	15 ± 2	13,000	109 ± 23	.300	.200	.468	.375	.312	16 Segment
KW-105S-TB	Digit	5	15 ± 2	13,000	52.5 ± 9.5	.300	.155	.468	.306	.312	7 Segment
KW-105S-DP-TB	Decimal Point	5	13 ± 2	13,000	4.2 ± 2.0	N/A	N/A	.468	.100	.312	1 Segment
KW-105S-CL-TB	Colon	5	13 ± 2	13,000	8.4 ± 4.0	N/A	N/A	.468	.100	.312	2 Segment
KW-105-S-L1-TB	Numeric 1	5	15 ± 2	13,000	15 ± 3	.300	N/A	.468	.100	.312	2 Segment
KW-105G-H	Digit	5	15 ± 2	13,000	52.5 ± 9.5	.300	.155	.468	.306	.185	7 Segment
KW-115G	Digit with D.P.	5	15 ± 2	13,000	52.5 ± 9.5*	.300	.155	.605	.306	.185	7 Seg. with D.P.
KW-105G-AL	Alphanumeric	5	15 ± 2	13,000	109 ± 23	.300	.200	.468	.375	.185	16 Segment
KW-105G-AL-DIP	Alphanumeric	5	15 ± 2	13,000	109 ± 23	.300	.200	.626	.375	.185	16 Segment
KW-105G-DIP	Digit	5	15 ± 2	13,000	52.5 ± 9.5	.300	.155	.740	.400	.270	7 Segment
KW-115G-DIP	Digit with D.P.	5	15 ± 2	13,000	52.5 ± 9.5*	.300	.155	.740	.400	.270	7 Seg. with D.P.
KW-135G-DIP	Digit with Colon	5	15 ± 2	13,000	52.5 ± 9.5*	.300	.155	.740	.400	.270	7 Seg. with Colon
KW-105RG	Digit	5	15 ± 2	13,000	52.5 ± 9.5*	.300	.155	.468	.306	.937	7 Segment
KW-105AL-RG	Alphanumeric	5	15 ± 2	13,000	109 ± 23	.300	.200	.468	.375	1.138	16 Segment
KWD-105AL-RG	Alphanumeric	5	15 ± 2	13,000	109 ± 23	.300	.200	.468	.375	1.138	16 Seg. with Diode

KW-200

KW-204S	Digit	4	14 ± 2	13,000	33 ± 7	.225	.115	.375	.275	.312	7 Segment
KW-204S-NS	North/South	4	14 ± 2	13,000	33 ± 7	.225	.115	.375	.275	.312	7 Segment
KW-204S-EW	East/West	4	14 ± 2	13,000	42 ± 10	.225	.115	.375	.275	.312	9 Segment
KW-204S-LR	Left/Right	4	14 ± 2	13,000	33 ± 7	.225	.115	.375	.275	.312	7 Segment
KW-204S-XY	X/Y	4	14 ± 2	13,000	19 ± 5	.225	.115	.375	.275	.312	4 Segment
KW-204S-PM	Plus/Minus	4	14 ± 2	13,000	10 ± 3	.115	.115	.375	.275	.312	2 Segment
KW-204S-DP	Decimal Point	4	10 ± 1.5	13,000	2.7 ± 1.4	N/A	N/A	.375	.075	.312	1 Segment
KW-204S-CL	Colon	4	10 ± 1.5	13,000	5.4 ± 2.8	N/A	N/A	.375	.075	.312	2 Segment
KW-204S-L1	Numeric 1	4	14 ± 2	13,000	10 ± 3	.225	N/A	.375	.075	.312	2 Segment
KW-204AL	Alphanumeric	4	14 ± 2	13,000	75 ± 15	.225	.187	.375	.335	.312	16 Segment
KW-204S-TB	Digit	4	14 ± 2	13,000	33 ± 7	.225	.115	.375	.275	.312	7 Segment

*MCD does not include D/P or Colon

Specifications

Part No.	Description	Voltage (V)	Current Per Segment (mA)	Average Brightness (Ft/L)	Milli-candela (MCD)	Character (in)		Dimensions (in)			Remarks
						Height	Width	H	W	D	
KW-200											
KW-204S-DP-TB	Decimal Point	4	10 ± 1.5	13,000	2.7 ± 1.4	N/A	N/A	.375	.075	.312	1 Segment
KW-204S-CL-TB	Colon	4	10 ± 1.5	13,000	5.4 ± 2.8	N/A	N/A	.375	.075	.312	2 Segment
KW-204S-L1-TB	Numeric 1	4	14 ± 2	13,000	10 ± 3	.225	N/A	.375	.075	.312	2 Segment
KW-204G-AL	Alphanumeric	4	14 ± 2	13,000	75 ± 15	.225	.187	.375	.335	.185	16 Segment
KW-204G-AL-DIP	Alphanumeric	4	14 ± 2	13,000	75 ± 15	.225	.187	.626	.335	.185	16 Segment
KW-204AL-RG	Alphanumeric	4	14 ± 2	13,000	75 ± 15	.225	.187	.375	.335	1.138	16 Segment
KWD-204AL-RG	Alphanumeric	4	14 ± 2	13,000	75 ± 15	.225	.187	.375	.335	1.138	16 Seg. with Diode
KW-205S	Digit	5	12 ± 2	13,000	40 ± 6	.225	.115	.375	.275	.312	7 Segment
KW-205S-NS	North/South	5	12 ± 2	13,000	40 ± 6	.225	.115	.375	.275	.312	7 Segment
KW-205S-EW	East/West	5	12 ± 2	13,000	51 ± 10	.225	.115	.375	.275	.312	9 Segment
KW-205S-LR	Left/Right	5	12 ± 2	13,000	40 ± 6	.225	.115	.375	.275	.312	7 Segment
KW-205S-XY	X/Y	5	12 ± 2	13,000	23 ± 5	.225	.115	.375	.275	.312	4 Segment
KW-205S-PM	Plus/Minus	5	12 ± 2	13,000	11 ± 2.5	.115	.115	.375	.275	.312	2 Segment
KW-205S-DP	Decimal Point	5	10 ± 1.5	13,000	3.2 ± 1.6	N/A	N/A	.375	.075	.312	1 Segment
KW-205S-CL	Colon	5	10 ± 1.5	13,000	6.4 ± 3.2	N/A	N/A	.375	.075	.312	2 Segment
KW-205S-L1	Numeric 1	5	12 ± 2	13,000	11 ± 2.5	.225	N/A	.375	.075	.312	2 Segment
KW-205AL	Alphanumeric	5	12 ± 2	13,000	89 ± 16	.225	.187	.375	.335	.312	16 Segment
KW-205S-TB	Digit	5	12 ± 2	13,000	40 ± 6	.225	.115	.375	.275	.312	7 Segment
KW-205S-DP-TB	Decimal Point	5	10 ± 1.5	13,000	3.2 ± 1.6	N/A	N/A	.375	.075	.312	1 Segment
KW-205S-CL-TB	Colon	5	10 ± 1.5	13,000	6.4 ± 3.2	N/A	N/A	.375	.075	.312	2 Segment
KW-205S-L1-TB	Numeric 1	5	12 ± 2	13,000	11 ± 2.5	.225	N/A	.375	.075	.312	2 Segment
KW-205G-AL	Alphanumeric	5	12 ± 2	13,000	89 ± 16	.225	.187	.375	.335	.185	16 Segment
KW-205G-AL-DIP	Alphanumeric	5	12 ± 2	13,000	89 ± 16	.225	.187	.626	.335	.185	16 Segment
KW-205AL-RG	Alphanumeric	5	12 ± 2	13,000	89 ± 16	.225	.187	.375	.335	1.138	16 Segment
KWD-205AL-RG	Alphanumeric	5	12 ± 2	13,000	89 ± 16	.225	.187	.375	.335	1.138	16 Seg. with Diode
KW-300											
KW-304	Digit	4	12 ± 2	13,000	30 ± 6	.167	.086	.305	.225	.185	7 Segment
KW-500											
KW-515	Digit with D.P.	5	15 ± 2 (D.P. 7 ± 2)	10,000	60 ± 15	.472	.236	.886	.473	.227	7 Seg. with D.P.
KW-505F-8/-15	Digit	5	8/15 ± 2	700/4500	2.4 ± .4/ 20 ± 5	.362	.200	.865	.440	.236	7 Segment
KW-515F-8/-15	Digit with D.P.	5	8/15 ± 2 (D.P. 7 ± 2)	700/4500	2.4 ± .4/ 20 ± 5	.362	.200	.865	.440	.236	7 Seg. with D.P.
KW-600											
KW-615-17	Digit with D.P.	5	17 ± 2	10,000	70 ± 18	.614	.362	1.083	.630	.228	7 Seg. with D.P.
KW-615-30	Digit with D.P.	5	30 ± 4	13,000	—	.614	.362	1.083	.630	.228	7 Seg. with D.P.
ML "X"-200											
KW-ML2-214S	Digit with D.P.	4	14 ± 2	13,000	33 ± 7 (per digit)	.225	.115	.378	.602	.394	2 Digit with 1 D.P.
KW-ML3-214S	Digit with D.P.	4	14 ± 2	13,000	33 ± 7 (per digit)	.225	.115	.378	.850	.394	3 Digit with 2 D.P.
KW-ML4-214S	Digit with D.P.	4	14 ± 2	13,000	33 ± 7 (per digit)	.225	.115	.378	1.100	.394	4 Digit with 3 D.P.
KW-ML5-214S	Digit with D.P.	4	14 ± 2	13,000	33 ± 7 (per digit)	.225	.115	.378	1.346	.394	5 Digit with 4 D.P.
KW-ML6-214S	Digit with D.P.	4	14 ± 2	13,000	33 ± 7 (per digit)	.225	.115	.378	1.594	.394	6 Digit with 5 D.P.
KW-ML2-215S	Digit with D.P.	5	12 ± 2	13,000	40 ± 6 (per digit)	.225	.115	.378	.602	.394	2 Digit with 1 D.P.
KW-ML3-215S	Digit with D.P.	5	12 ± 2	13,000	40 ± 6 (per digit)	.225	.115	.378	.850	.394	3 Digit with 2 D.P.
KW-ML4-215S	Digit with D.P.	5	12 ± 2	13,000	40 ± 6 (per digit)	.225	.115	.378	1.100	.394	4 Digit with 3 D.P.
KW-ML5-215S	Digit with D.P.	5	12 ± 2	13,000	40 ± 6 (per digit)	.225	.115	.378	1.346	.394	5 Digit with 4 D.P.
KW-ML6-215S	Digit with D.P.	5	12 ± 2	13,000	40 ± 6 (per digit)	.225	.115	.378	1.594	.394	6 Digit with 5 D.P.
KW-BG											
KW-BG-20S	Bar-Graph	4 & 5	10 MAX.	9,000	**	.125	.05 × 19	.250	1.18	.394	20 elements
KW-BG-30	Bar-Graph	4 & 5	10 MAX.	9,000	**	.180	.04 × 29	.300	1.44	.300	30 elements
KW-BG-36S	Bar-Graph	4 & 5	10 MAX.	9,000	**	.125	.05 × 35	.250	1.98	.394	36 elements
KW-BG-50	Bar-Graph	4 & 5	10 MAX.	9,000	**	.180	.04 × 49	.300	2.24	.300	50 elements
KW-BG-56S	Bar-Graph	4 & 5	10 MAX.	9,000	**	.125	.05 × 55	.250	2.98	.394	56 elements
KW-BG-100	Bar-Graph	4 & 5	10 MAX.	9,000	**	.180	.04 × 49	.300	4.24	.300	100 elements
KW-BGR											
KW-BGR-46S 1)	Round-Graph	5	15 ± 2	10,000	**	φ 1.61	.157	1.81	—	.394	60 elements
KW-BGR-75S 1)	Round-Graph	5	15 ± 2	10,000	**	φ 2.71	.197	2.95	—	.500	72 elements

Other sizes available (same size as "KW" type)
Note 1. Other sizes available consult factory.

** Consult Factory

T-41-33
T-41-31 T-41-35

KW-104/105

Dimensional Outline & Pin Configurations

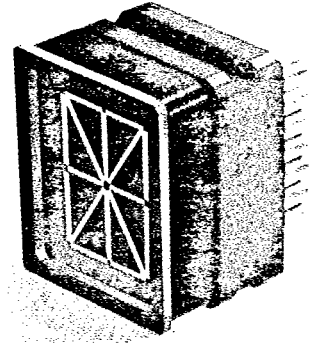
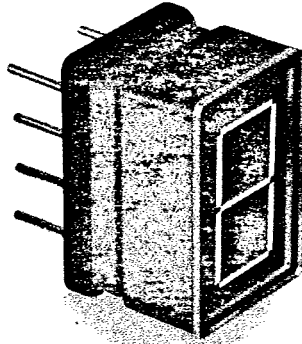
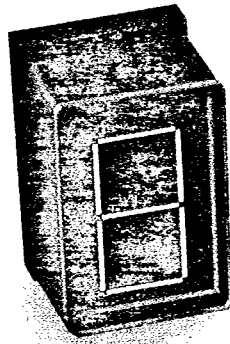

KW-104S
KW-105S

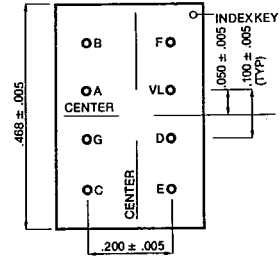
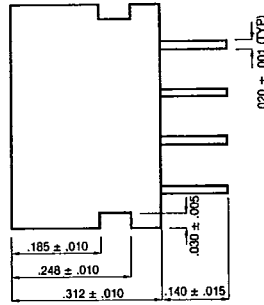
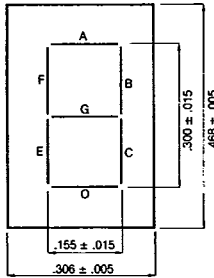

KW-104G-H
KW-105G-H

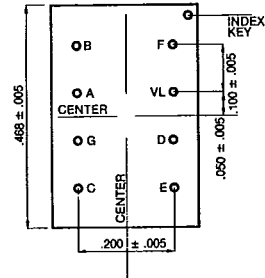
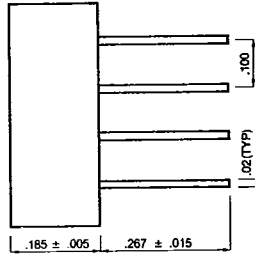
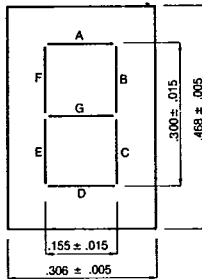

KW-114G
KW-115G

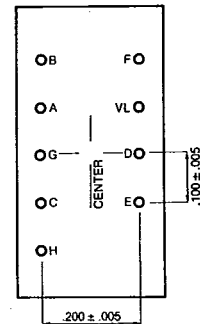
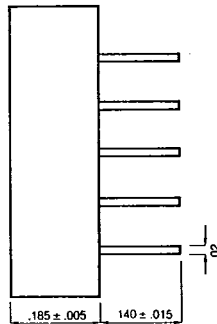
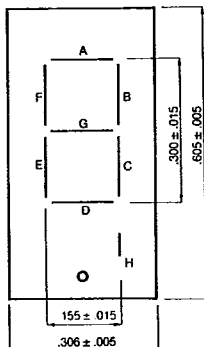

T-41-31

T-41-33

T-41-35

KW-104S-PM
KW-105S-PM

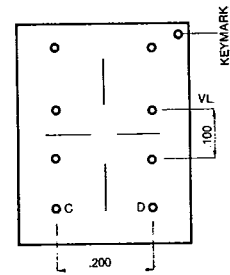
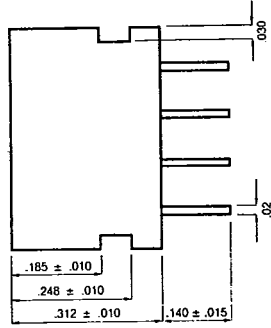
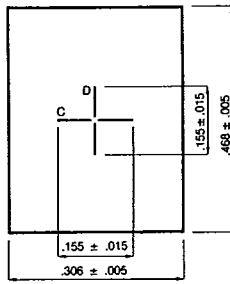

KW-104S-XY
KW-105S-XY
KW-104S-LR
KW-105S-LR

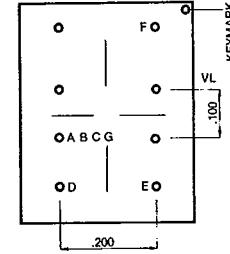
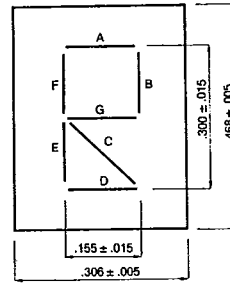
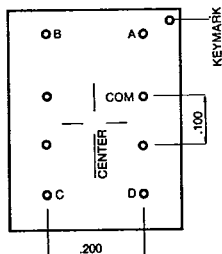
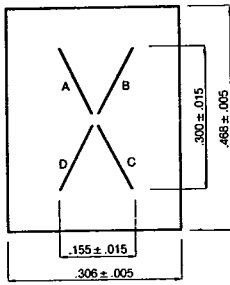

KW-104S-EW
KW-105S-EW
KW-104S-NS
KW-105S-NS

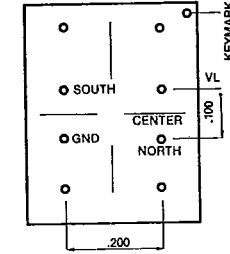
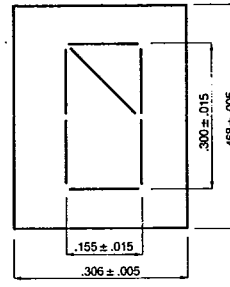
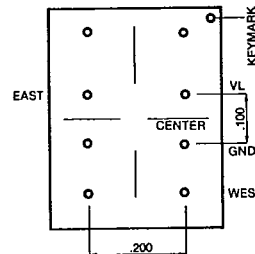
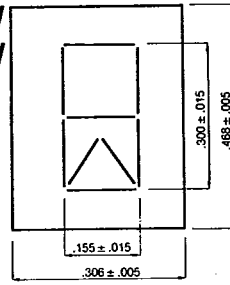

KW-104-AL
KW-105-AL

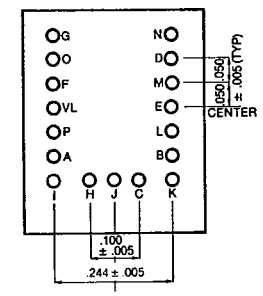
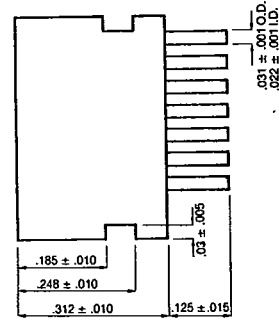
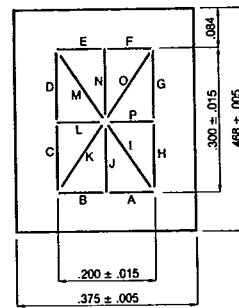

KW-104S-TB
KW-105S-TB

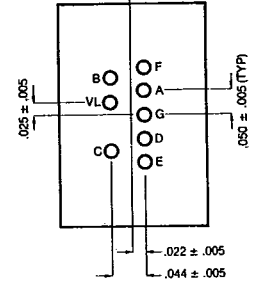
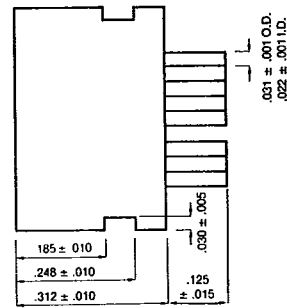
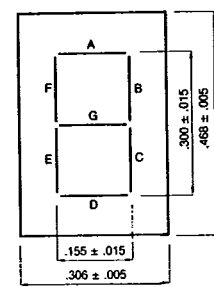

T-41-31

T-41-33

T-41-35

KW-105S-DP-TB
 KW-105S-LI-TB
 KW-104S-DP-TB
 KW-104S-LI-TB

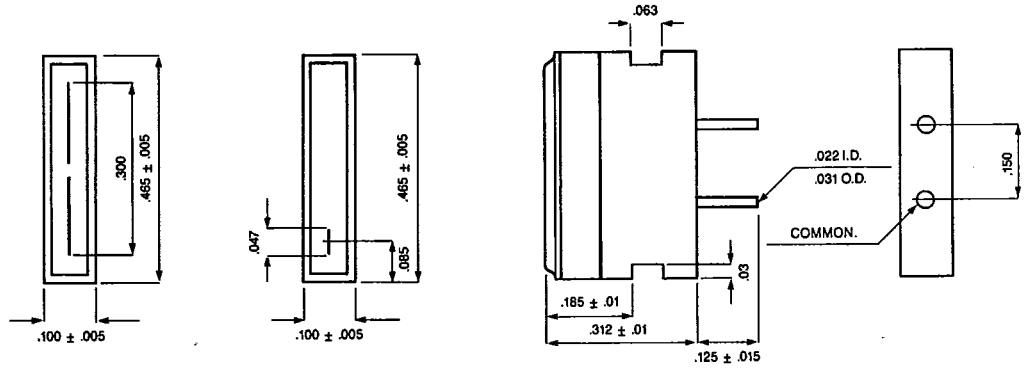

KW-105S-CL-TB
 KW-104S-CL-TB

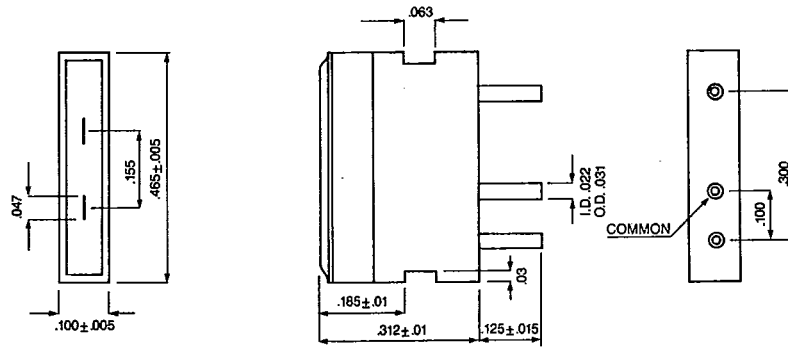

KW-105G-AL
 KW-104G-AL

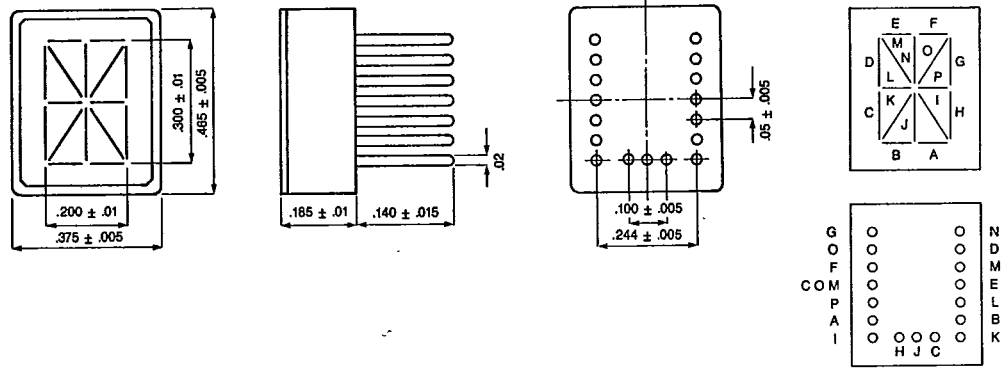

KW-105G-AL-DIP
 KW-104G-AL-DIP

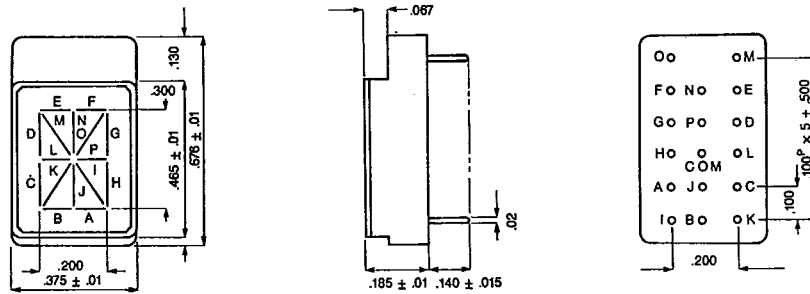

T-41-31

T-41-33

T-41-35

KW-104G/ 105G DIP

Dimensional
Outline & Pin
Configurations

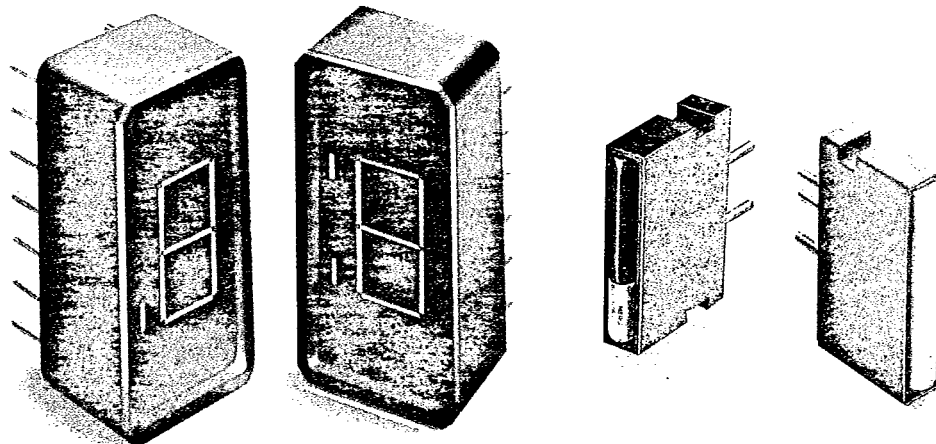

- KW-104G-DIP
- KW-105G-DIP
- KW-114G-DIP(D.P.)
- KW-115G-DIP(D.P.)
- KW-134G-DIP(colon)
- KW-135G-DIP(colon)

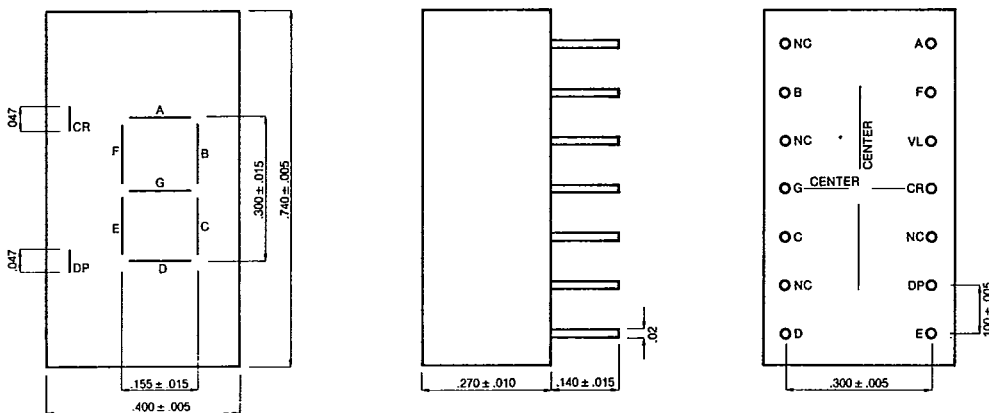

- KW-105S-DP or LI
- KW-104S-DP or LI

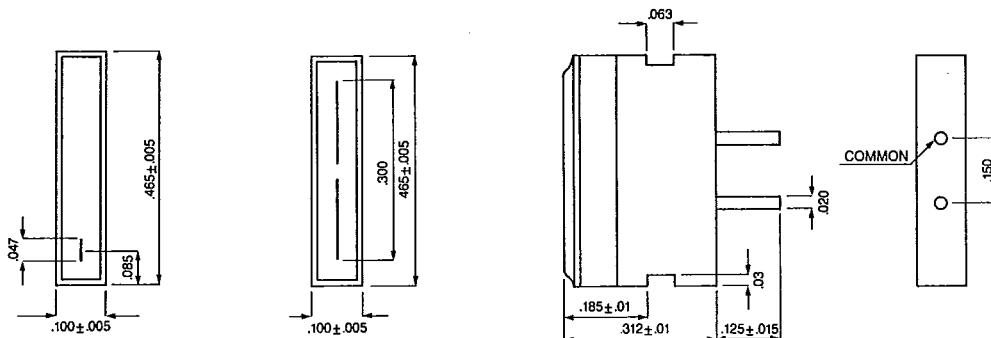

- KW-104S-CL
- KW-105S-CL

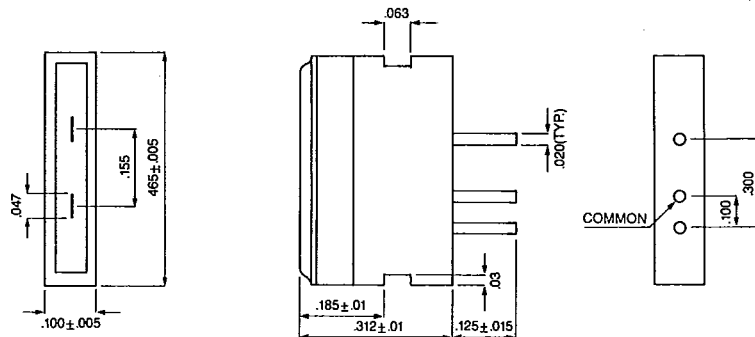

T-41-31 T-41-33 T-41-35

KW-204/205

Dimensional Outline & Pin Configuration

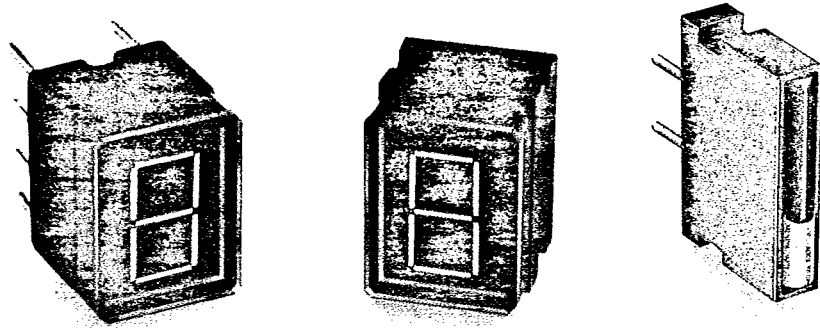

KW-204S
KW-205S

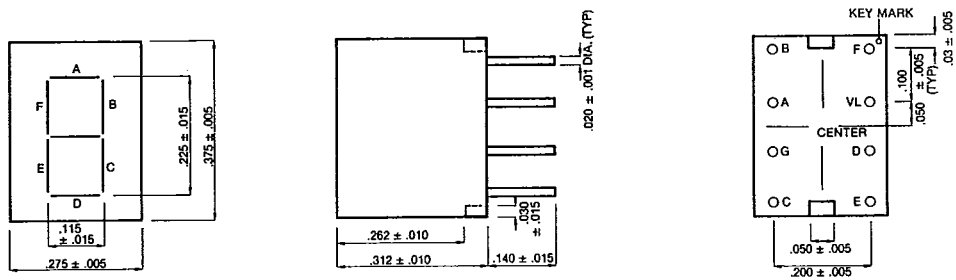

KW-204S-DP
KW-205S-DP
KW-204S-LI
KW-205S-LI
KW-204S-CL
KW-205S-CL

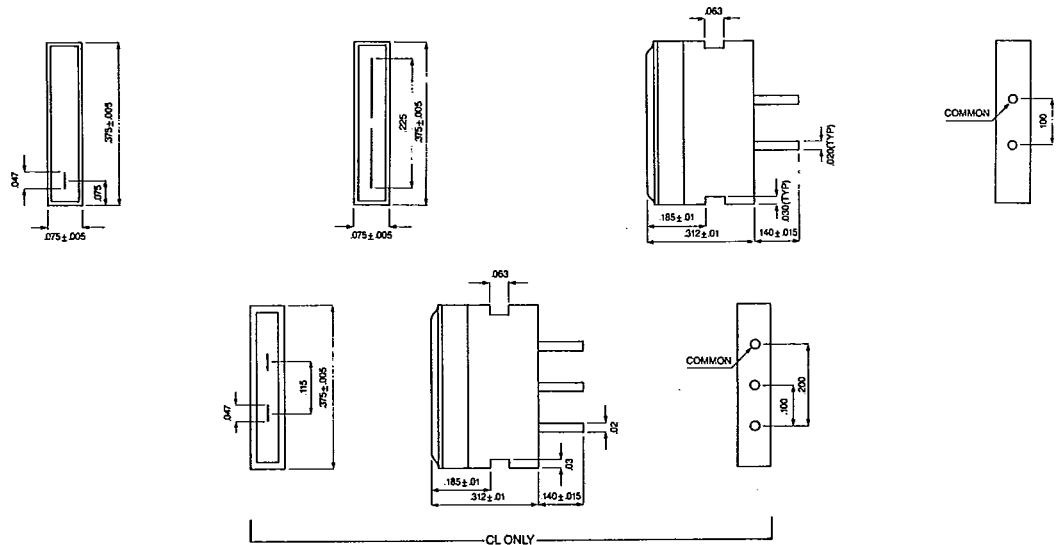

T-41-31

T-41-33

T-41-35

KW-204S-XY
KW-205S-XY

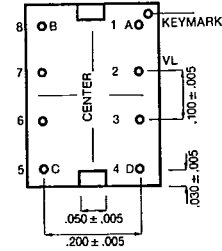
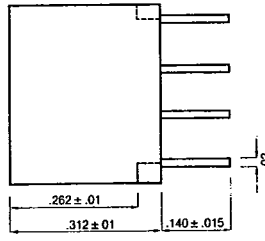
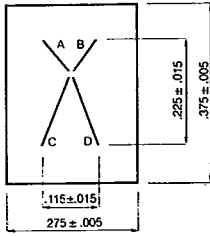

KW-204S-NS
KW-205S-NS

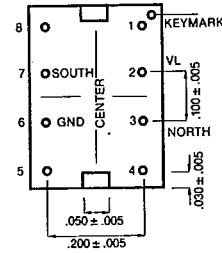
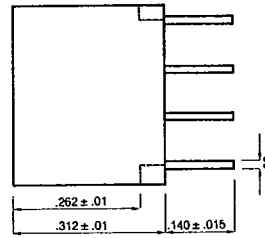
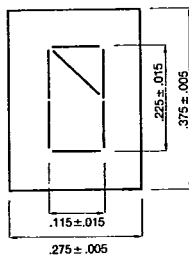

KW-204S-EW
KW-205S-EW

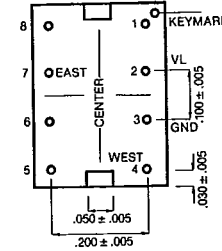
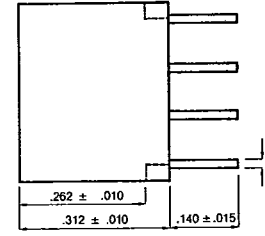
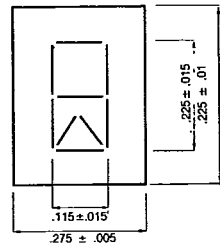

KW-204S-LR
KW-205S-LR

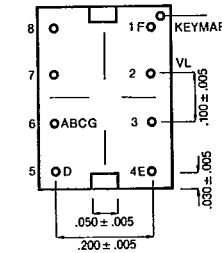
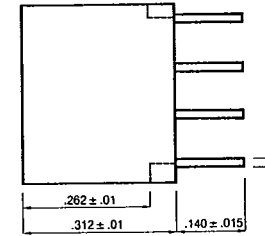
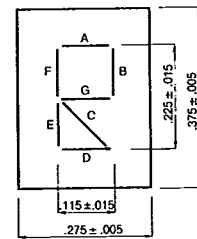

KW-204S-PM
KW-205S-PM

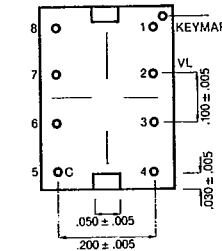
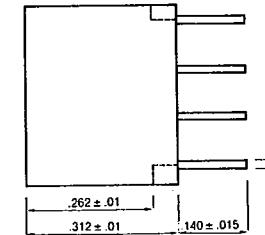
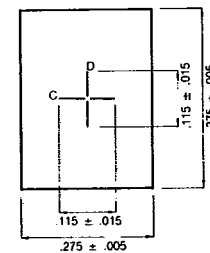

T-41-31

T-41-33
T-41-35

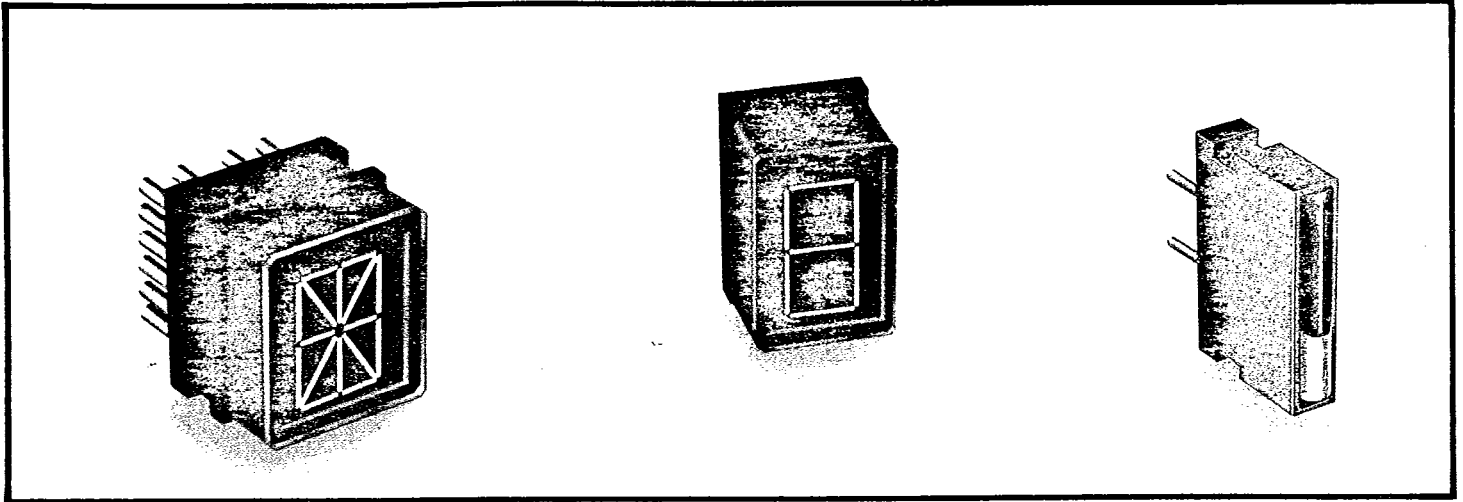

KW-204-AL
KW-205-AL

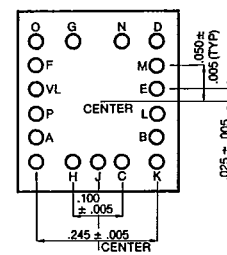
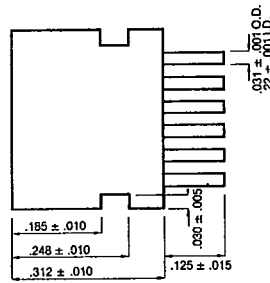
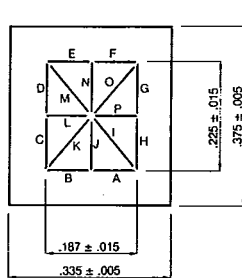

KW-204S-TB
KW-205S-TB

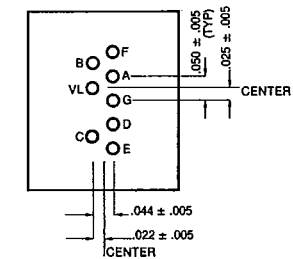
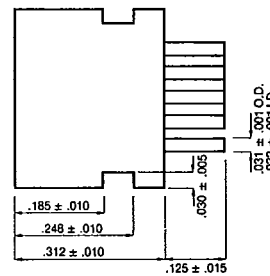
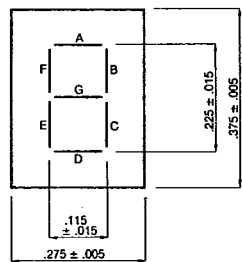

KW-204S-DP-TB
KW-205S-DP-TB
KW-204S-CL-TB
KW-205S-CL-TB

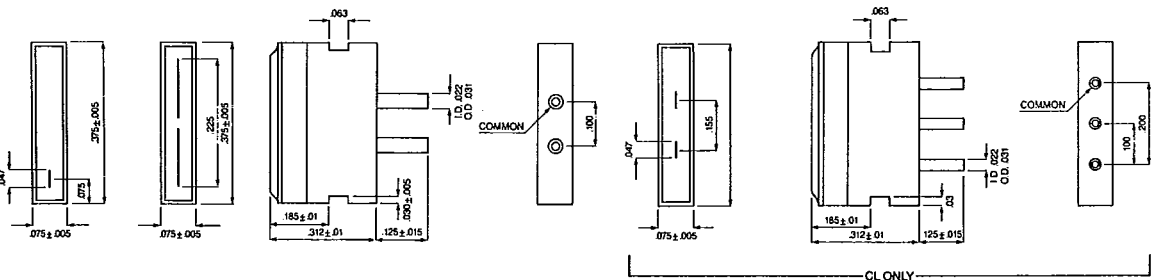

T-41-31 T-41-33 T-41-35

KW-205G-AL(5v)
KW-204G-AL(4v)

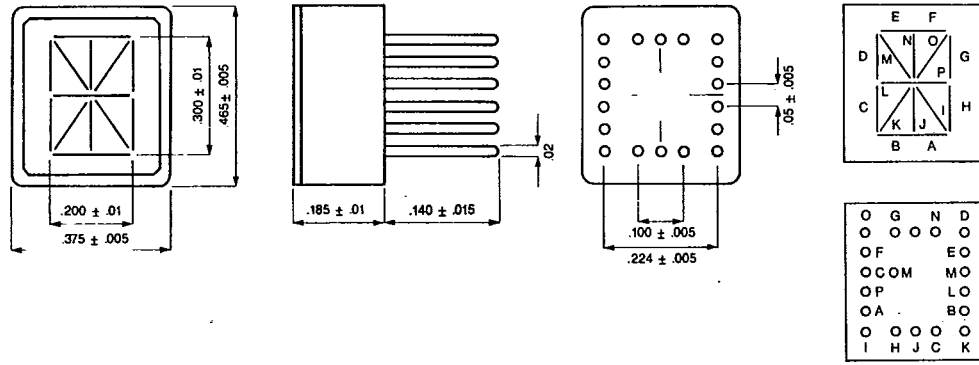

KW-205G-AL-DIP(5v)
KW-204G-AL-DIP(4v)

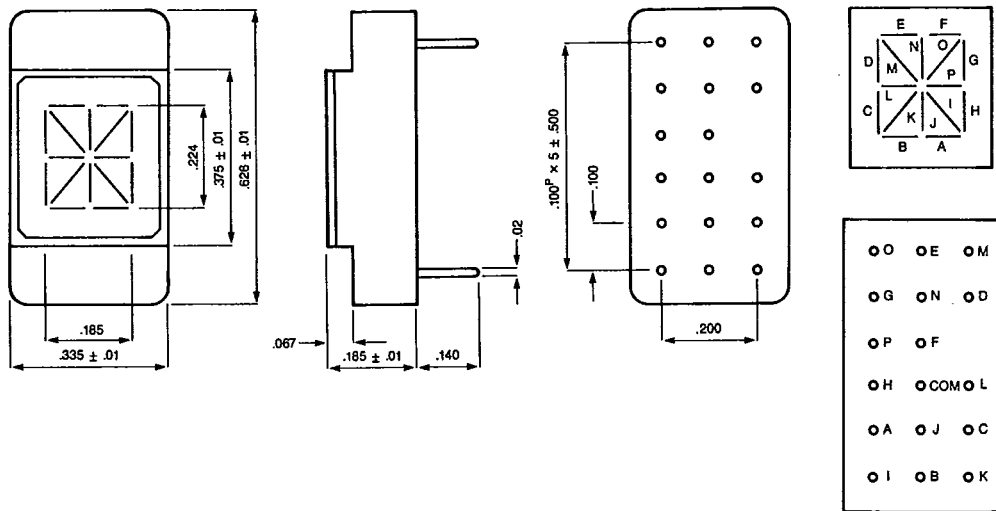

KW-304

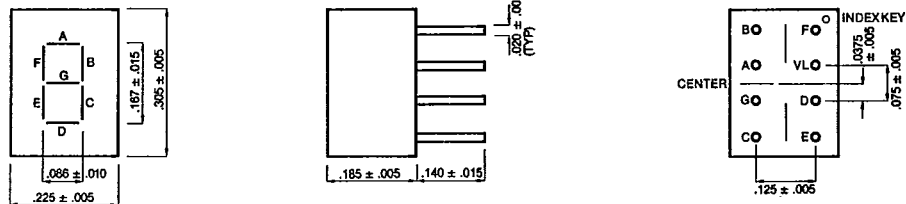

T-41-31

T-41-33

T-41-35

Right Angle Mount

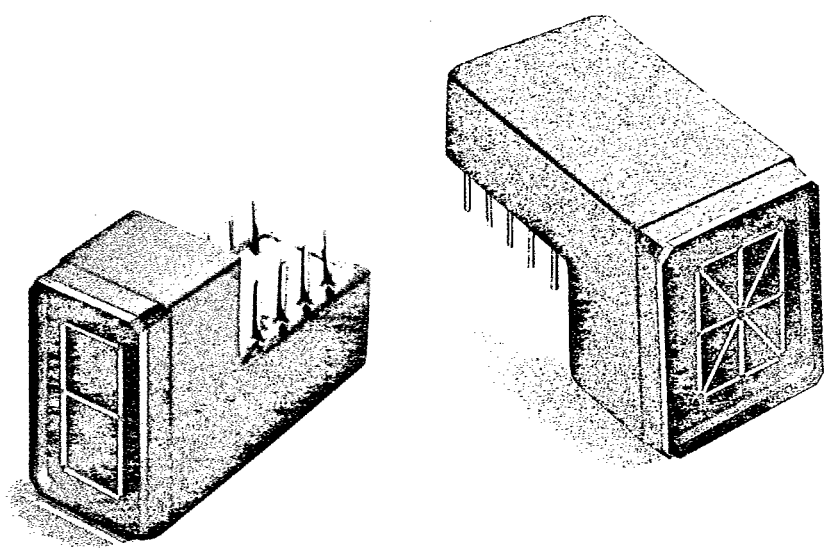

KW-104-RG
KW-105-RG

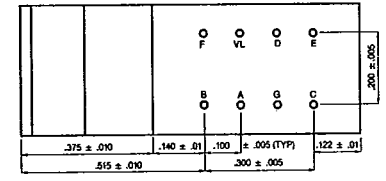
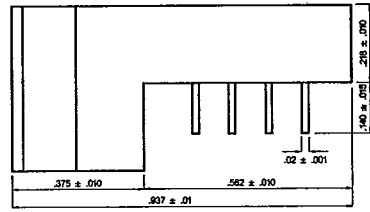
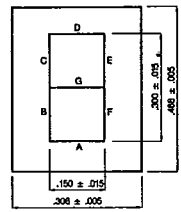

KW-105AL-RG
KWD-105AL-RG
KW-104AL-RG
KWD-104AL-RG

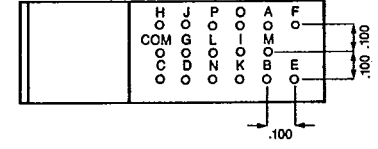
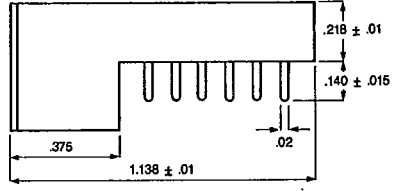
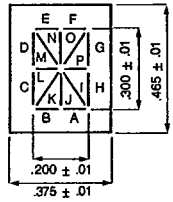

KW-205AL-RG
KWD-205AL-RG
KW-204AL-RG
KWD-204AL-RG

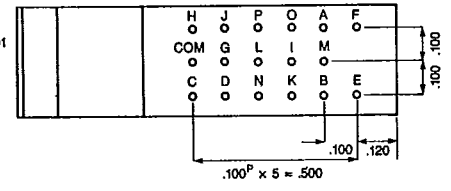
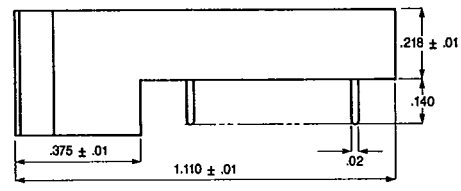
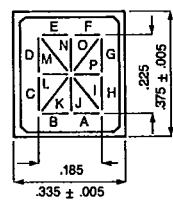

T-41-31
T-41-33
T-41-35

KW-505-F/515

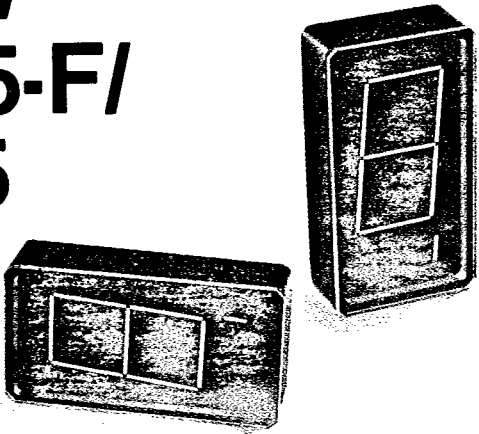

KW-614/615

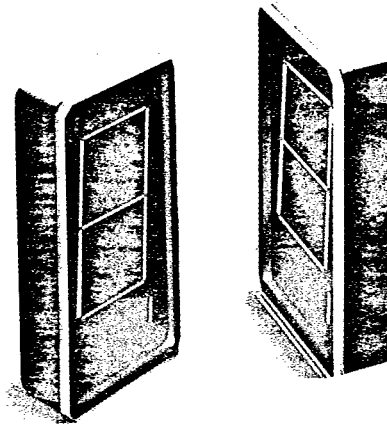

KW-505-F

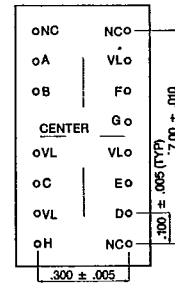
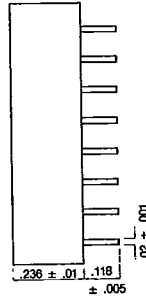
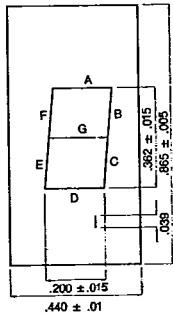

KW-515

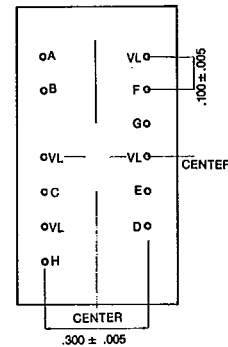
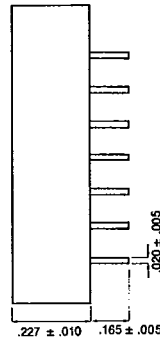
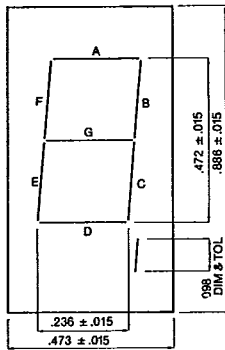

KW-614
KW-615

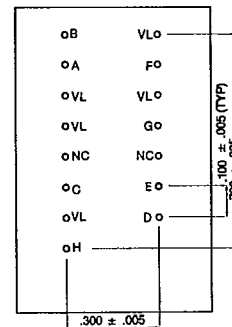
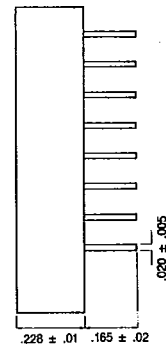
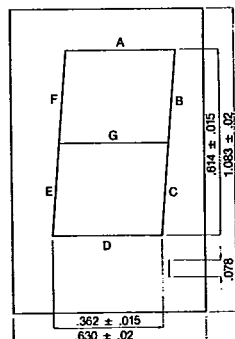

AS SHOWN (505, 515, 614, & 615) NOT TO SCALE

T-41-31

T-41-33
T-41-35

Bar Graphs

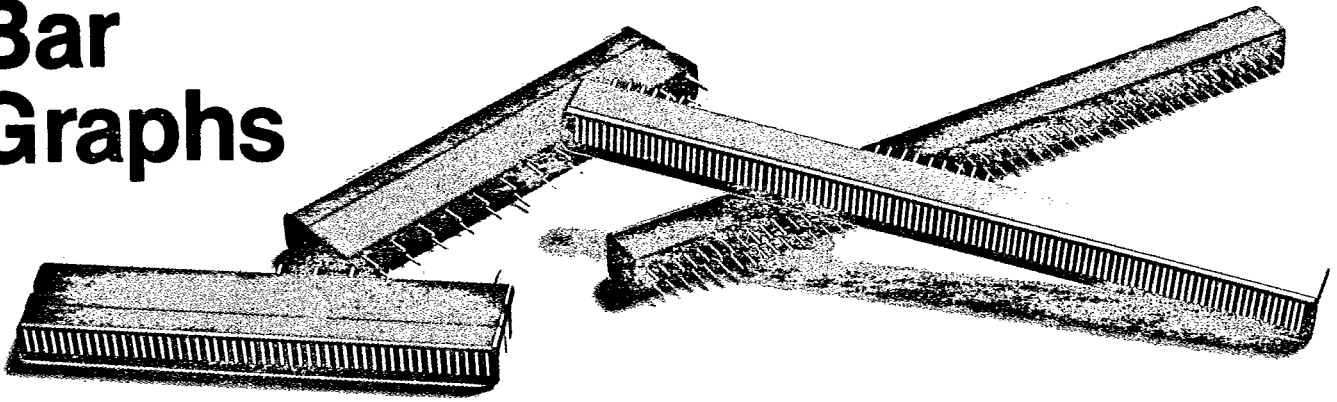

KW-BG Special Connector Mount *

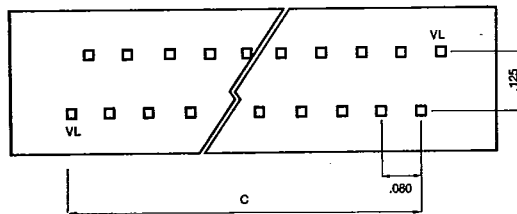
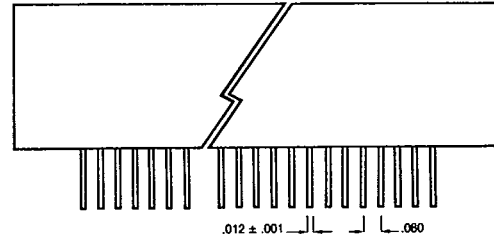
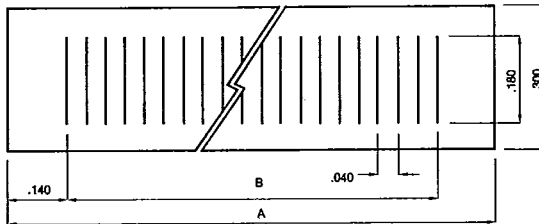

TYPE	A	B	C
KW-BG30	1.440	.040 × 29P	.080 × 15P
KW-BG50	2.240	.040 × 49P	.080 × 25P
KW-BG100	4.240	.040 × 49P	.080 × 50P

KW-BG Panel Mount

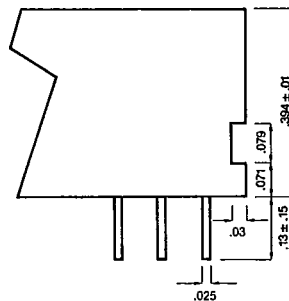
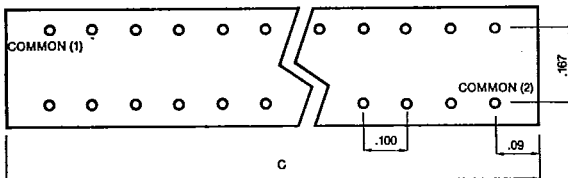
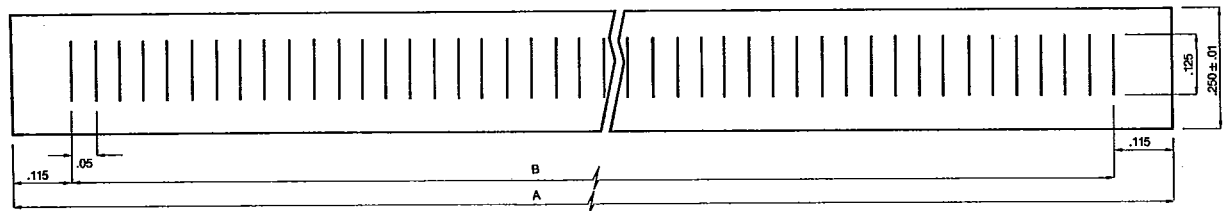

TYPE	A	B	C
KW-BG-20S	1.18	.05 × 19	.100 × 10
KW-BG-36S	1.98	.05 × 35	.100 × 18
KW-BG-56S	2.98	.05 × 55	.100 × 28

* Special connectors available; consult factory.

T-41-31

T-41-33

T-41-35

Multi-Digits

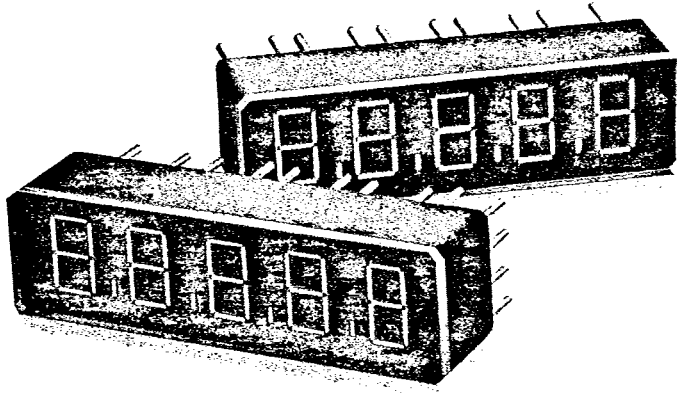

KW-ML-2-210S
KW-ML-2-214S
KW-ML-2-215S

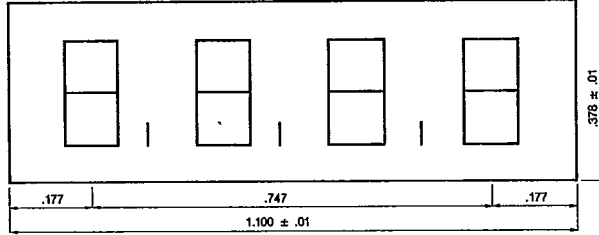
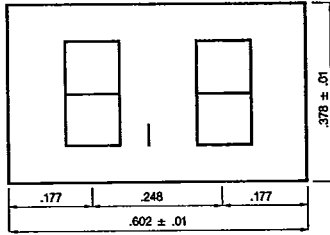

KW-ML-4-210S
KW-ML-4-214S
KW-ML-4-215S

KW-ML-3-210S
KW-ML-3-214S
KW-ML-3-215S

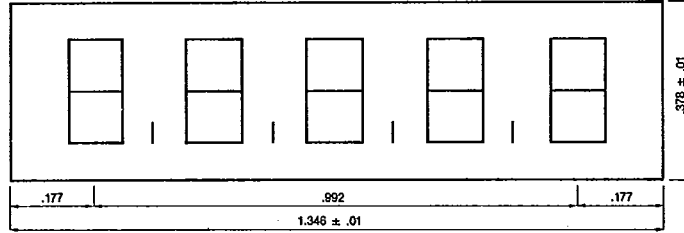
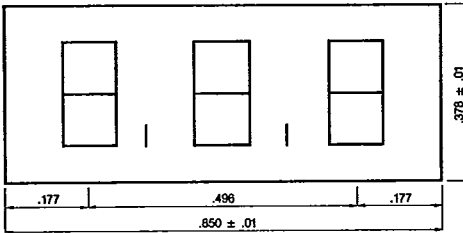

KW-ML-5-210S
KW-ML-5-214S
KW-ML-5-215S

KW-ML-6-210S
KW-ML-6-214S
KW-ML-6-215S

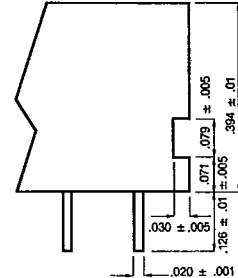
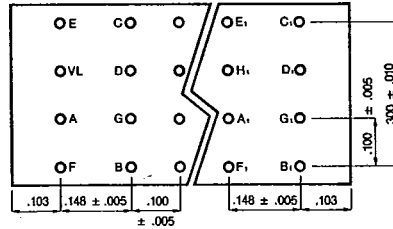
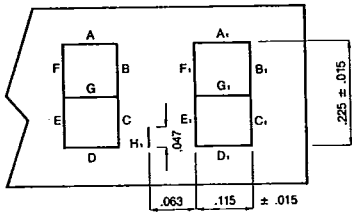
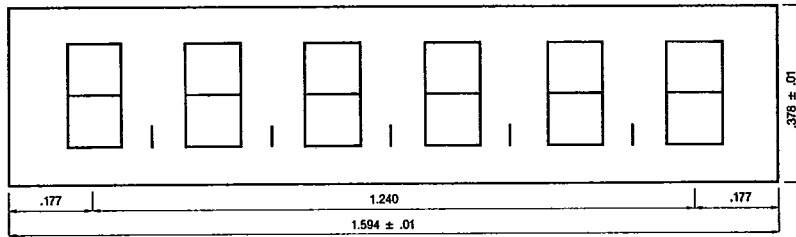

T-41-31

T-41-33
T-41-35

Round Bar Graphs

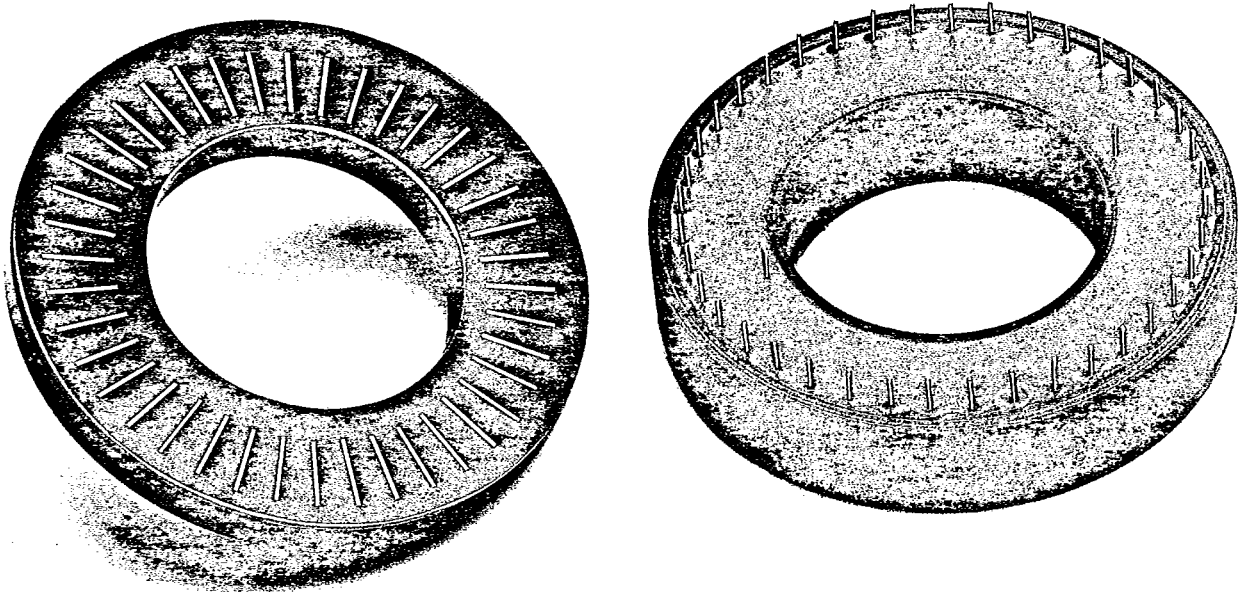

KW-BGR-46S

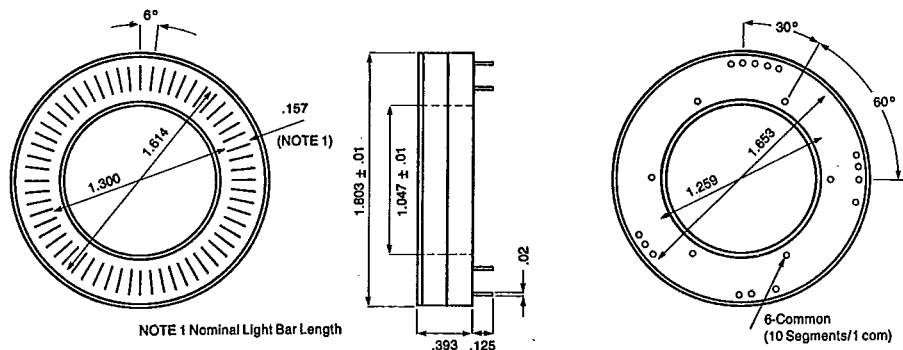

KW-CGR-75S

