

Product Overview

Qorvo's QPA1019D is a high-power, C-band amplifier fabricated on Qorvo's production 0.15 μm GaN on SiC process (QGaN15). Covering 4.5–7.0 GHz, the QPA1019D provides greater than 10 W of saturated output power and 19 dB of large-signal gain while achieving greater than 39% power-added efficiency.

The QPA1019D can also support a variety of operating conditions to best support system requirements. With good thermal properties, it can support a range of bias voltages.

The QPA1019D MMIC has DC blocking capacitors on both RF ports, which are matched to 50 ohms. The QPA1019D is ideal for radar and satellite communication systems.

Lead-free and RoHS compliant.

Evaluation board available on request.



Key Features

- Frequency Range: 4.5–7.0 GHz
- P_{SAT} ($P_{IN}=22$ dBm): > 40 dBm
- PAE ($P_{IN}=22$ dBm): > 39 %
- Power Gain ($P_{IN}=22$ dBm): > 19 dB
- Bias: $V_D = 22$ V, $I_{DQ} = 290$ mA, $V_G = -2.5$ V typical
- Chip Dimensions: 2.835 x 1.590 x 0.100 mm

Performance is typical across frequency. Please reference electrical specification table and data plots for more details.

Functional Block Diagram

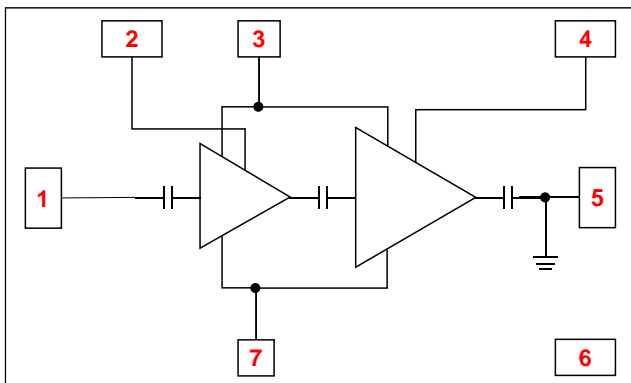

Applications

- C-Band Radar
- Satellite Communication

Ordering Information

Part No.	Description
QPA1019D	4.5–7.0 GHz 10 W GaN Power Amplifier (10 Pcs.)
QPA1019DEVB	Evaluation Board for QPA1019D

Absolute Maximum Ratings

Parameter	Value / Range
Drain Voltage (V_D)	29.5
Gate Voltage Range (V_G)	-6 to 0 V
Drain Current (I_{D1}, I_{D2})	0.52, 2.0 A
Gate Current (I_G)	50 mA
Power Dissipation (P_{DISS}), 85°C	25.2 W
Input Power (P_{IN}), 50 Ω , $V_D=22$ V, $I_{DQ}=290$ mA, 85 °C	28 dBm
Input Power (P_{IN}), 4:1 VSWR, $V_D=22$ V, $I_{DQ}=290$ mA, 85 °C	25 dBm
Channel Temperature (T_{CH})	275 °C
Mounting Temperature (30 seconds)	320 °C
Storage Temperature	-65 to 150 °C

Operation of this device outside the parameter ranges given above may cause permanent damage. These are stress ratings only, and functional operation of the device at these conditions is not implied.

Recommended Operating Conditions

Parameter	Value / Range
Drain Voltage (V_D)	22 V
Drain Current (I_{DQ})	290 mA
Gate Voltage (V_G), Typical	-2.5 V
Operating Temperature	-40 to +85 °C

Electrical specifications are measured at specified test conditions. Specifications are not guaranteed over all recommended operating conditions.

Electrical Specifications

Parameter	Min	Typ	Max	Units
Operational Frequency Range	4.5		7.0	GHz
Output Power (CW, $P_{IN} = 22$ dBm)	4.5 GHz 5.75 GHz 7.0 GHz	41.0 40.9 40.6		dBm dBm dBm
Power Added Efficiency (CW, $P_{IN} = 22$ dBm)	4.5 GHz 5.75 GHz 7.0 GHz	44.8 42.7 39.7		% % %
Small Signal Gain (CW)	4.5 GHz 5.75 GHz 7.0 GHz	33.4 33.5 34.4		dB dB dB
Input Return Loss (CW)	4.5 GHz 5.75 GHz 7.0 GHz	16 14 18		dB dB dB
Output Return Loss (CW)	4.5 GHz 5.75 GHz 7.0 GHz	14 7 10		dB dB dB
3 RD Intermodulation Products ($P_o/Tone = 32$ dBm), 5.75 GHz		-25		dBc
Output Power Temp. Coeff. (85 – 25 °C, $P_{IN} = 22$ dBm))		-0.007		dB/°C
Sm. Signal Gain Temperature Coefficient (85 to -40 °C)		-0.050		dB/°C

Test conditions, unless otherwise noted: $T = 25$ °C, $V_D = 22$ V, $I_{DQ} = 290$ mA, $V_G = -2.5$ V

Performance Plots – Large Signal

Test conditions unless otherwise noted: $V_D = 22\text{ V}$, $I_{DQ} = 290\text{ mA}$, CW input power, $T = +25\text{ }^\circ\text{C}$

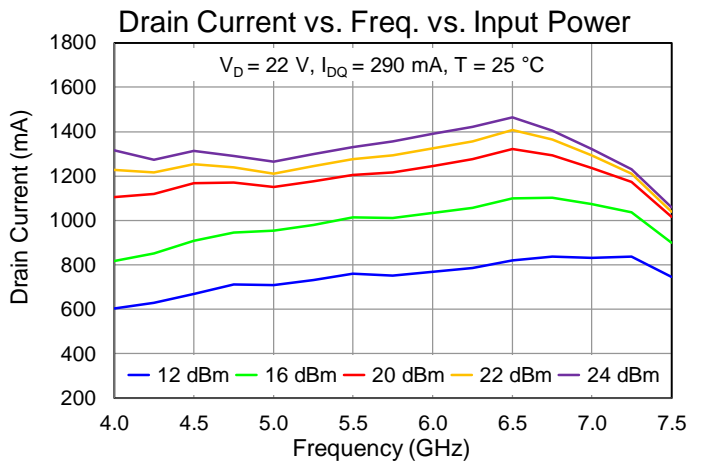
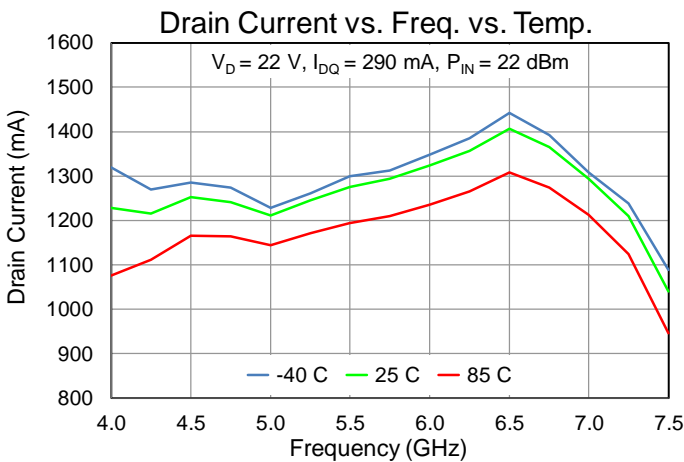
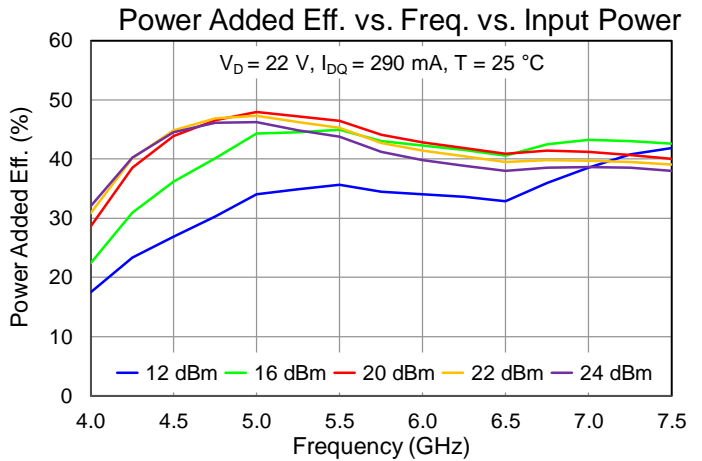
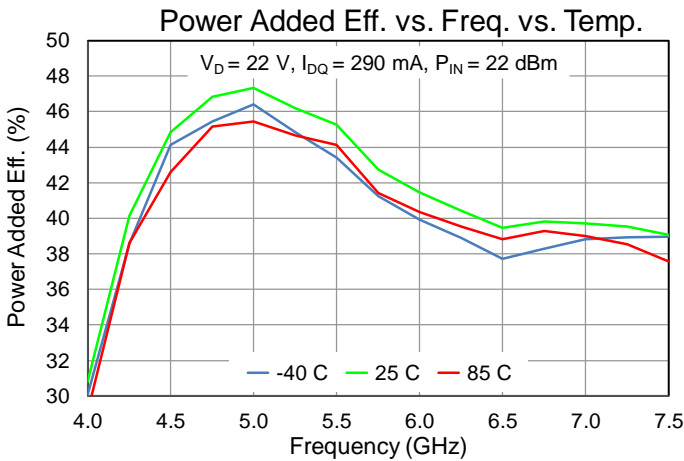
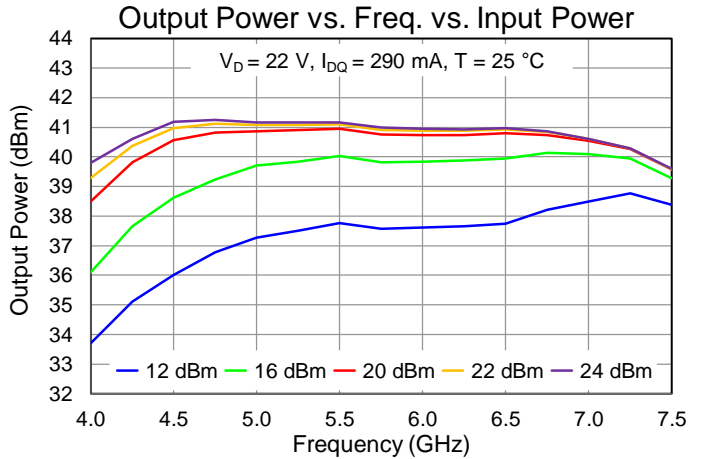
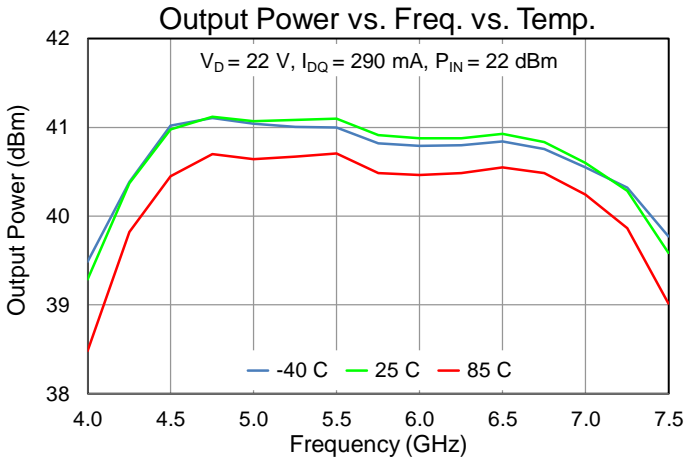

Performance Plots – Large Signal

Test conditions unless otherwise noted: $V_D = 22\text{ V}$, $I_{DQ} = 290\text{ mA}$, CW input power, $T = +25\text{ }^\circ\text{C}$

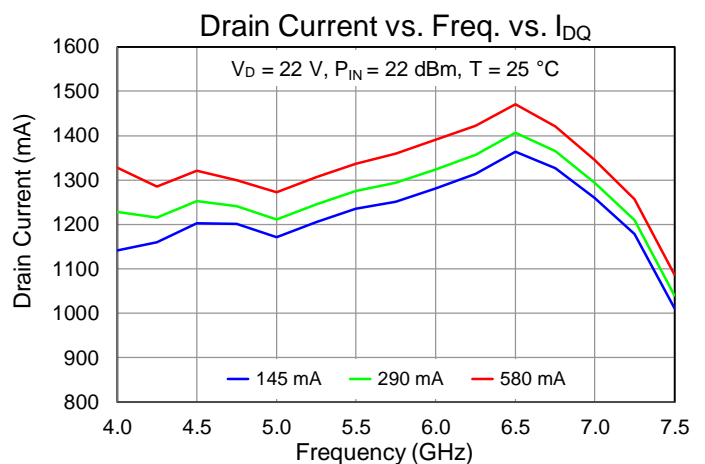
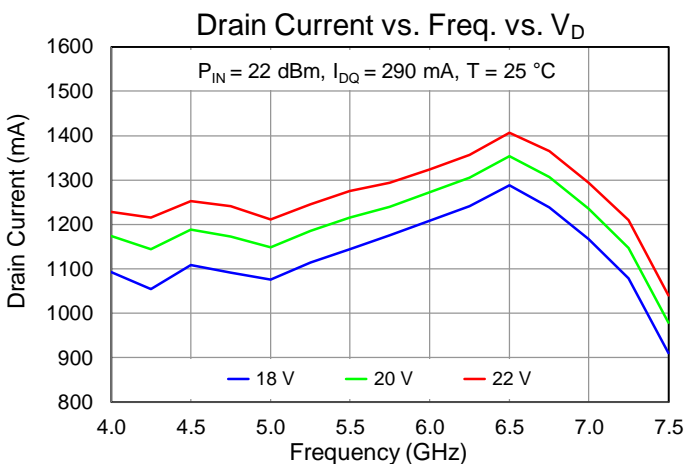
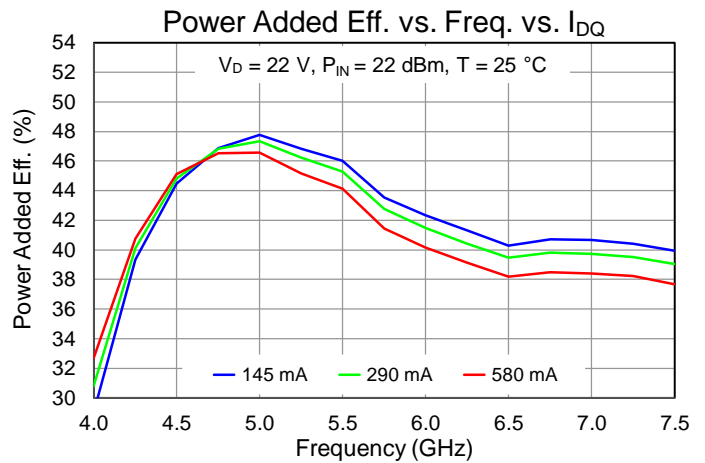
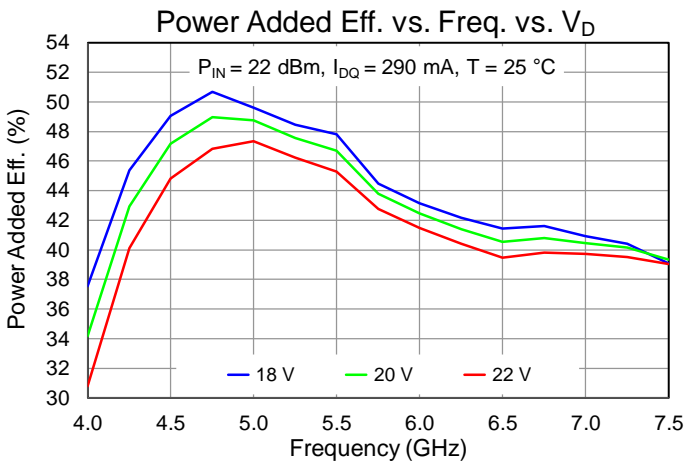
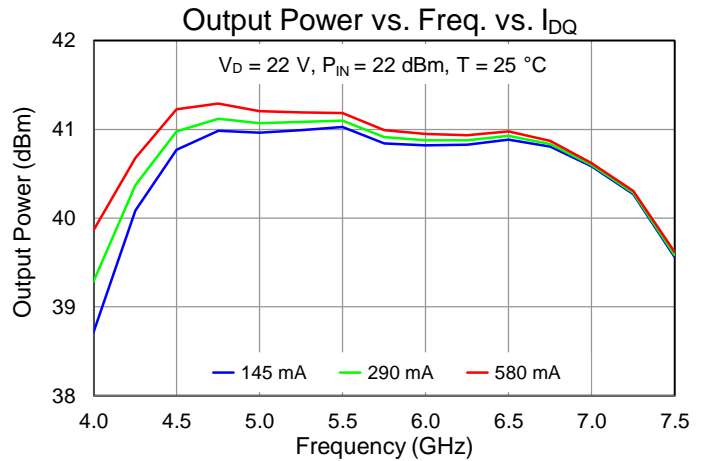
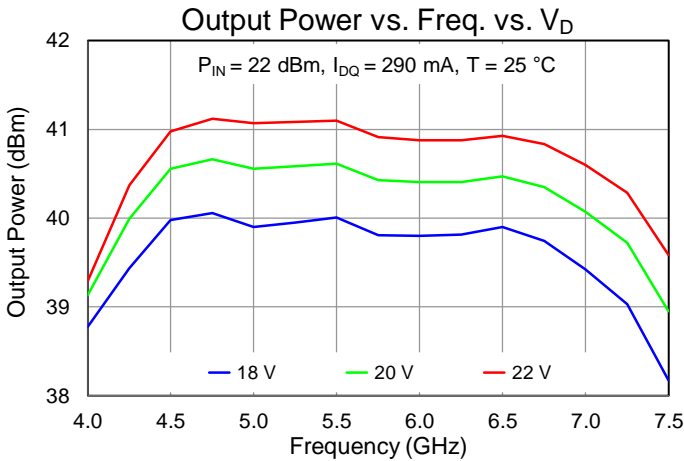

Performance Plots – Large Signal

Test conditions unless otherwise noted: $V_D = 22\text{ V}$, $I_{DQ} = 290\text{ mA}$, CW input power, $T = +25\text{ }^\circ\text{C}$

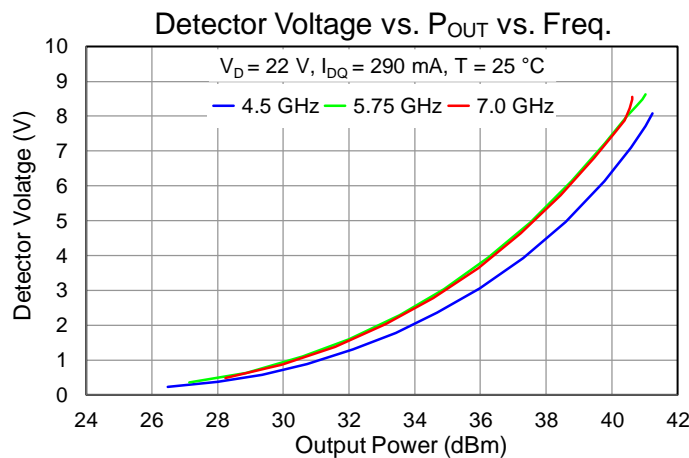
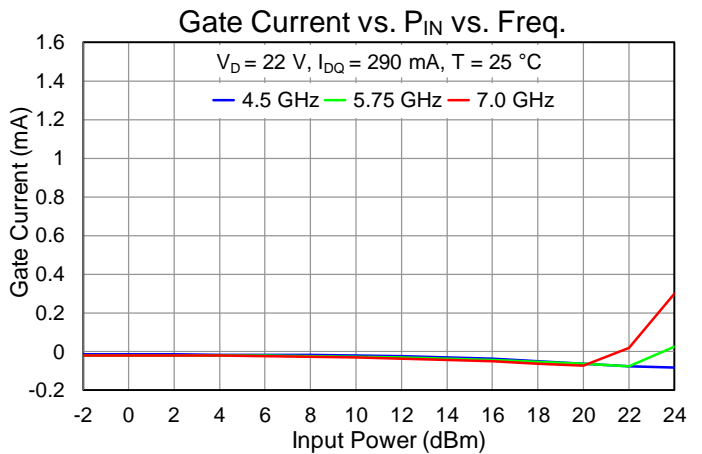
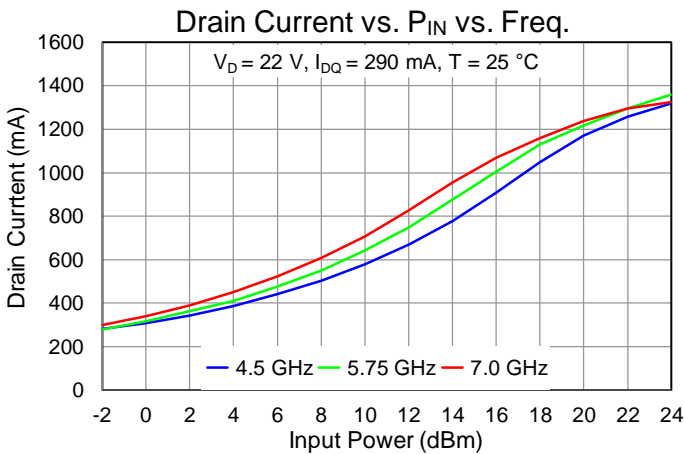
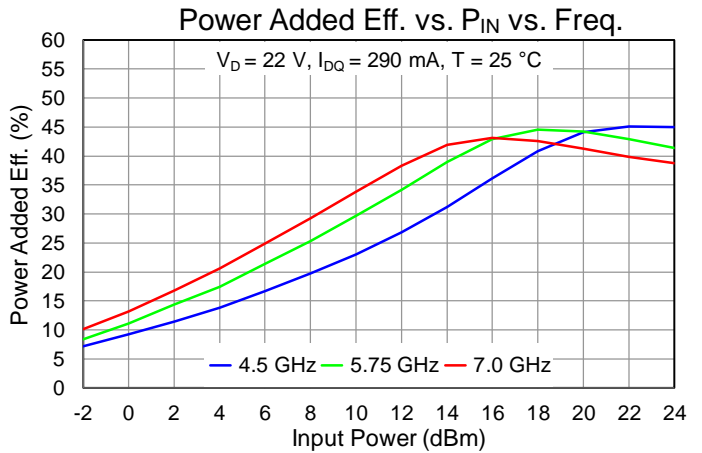
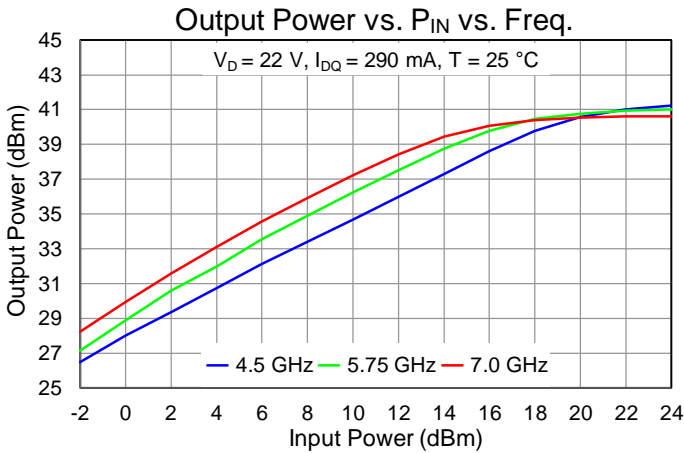

Performance Plots – Large Signal

Test conditions unless otherwise noted: $V_D = 22\text{ V}$, $I_{DQ} = 290\text{ mA}$, CW input power, $T = +25\text{ }^\circ\text{C}$

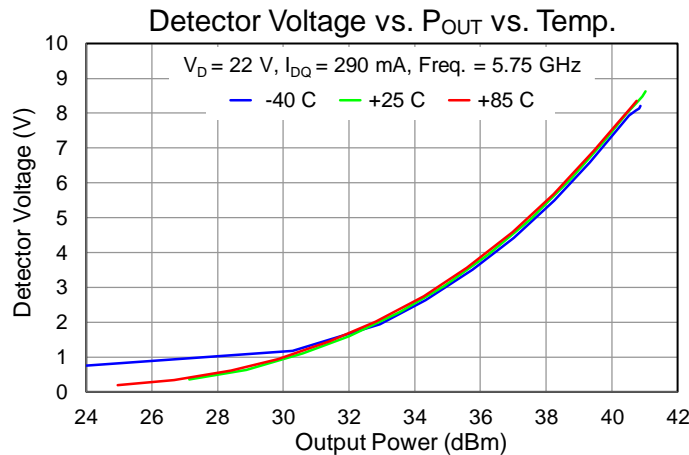
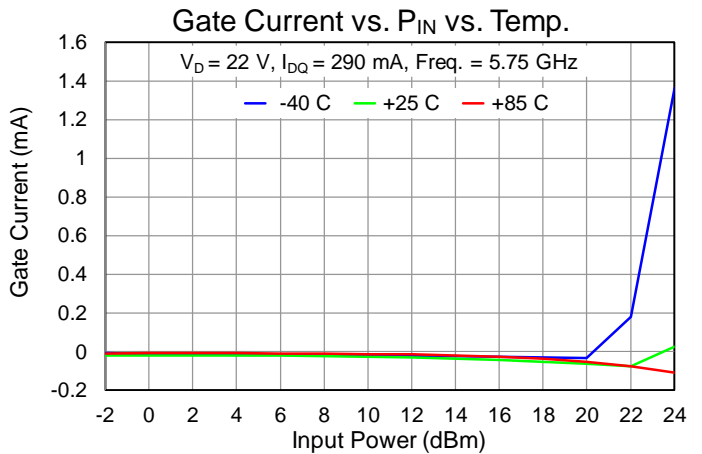
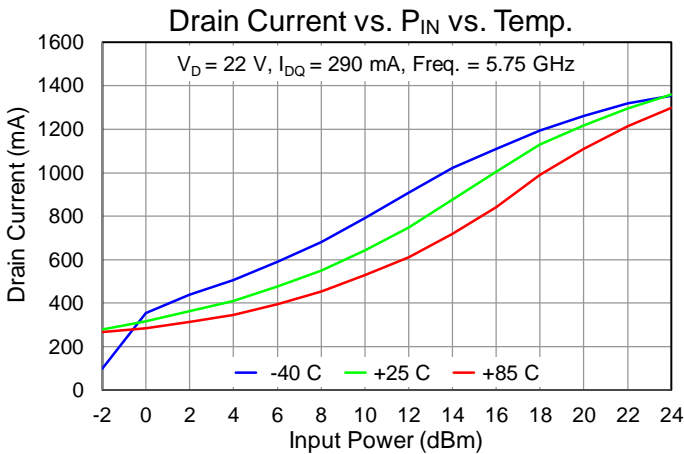
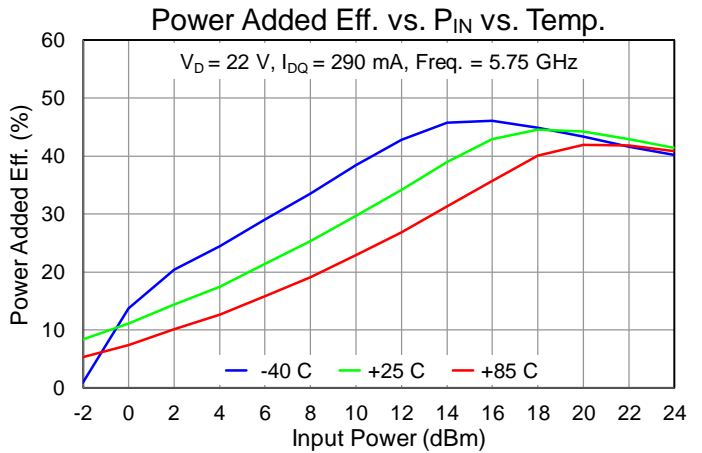
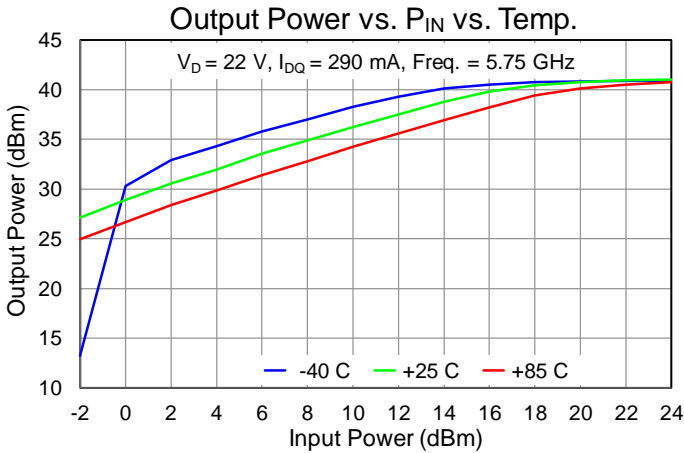

Performance Plots – Large Signal

Test conditions unless otherwise noted: $V_D = 22\text{ V}$, $I_{DQ} = 290\text{ mA}$, CW input power, $T = +25\text{ }^\circ\text{C}$

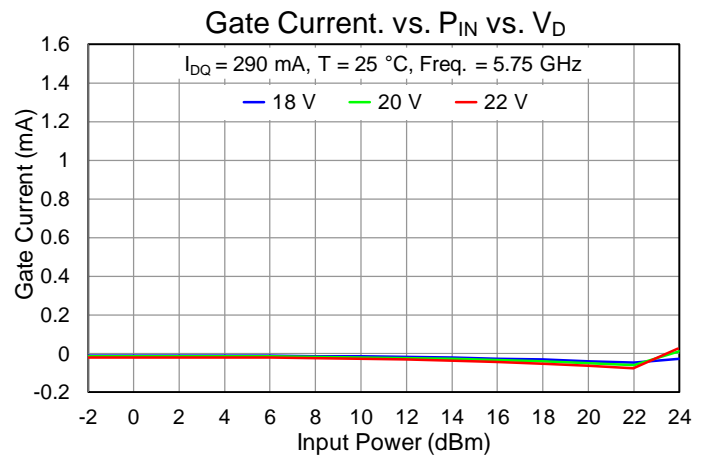
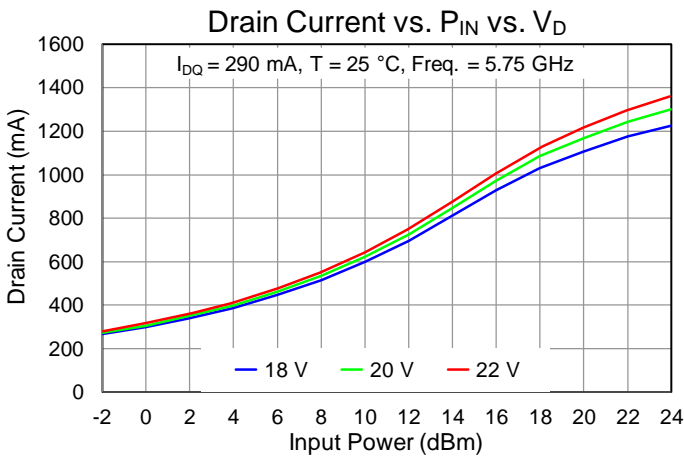
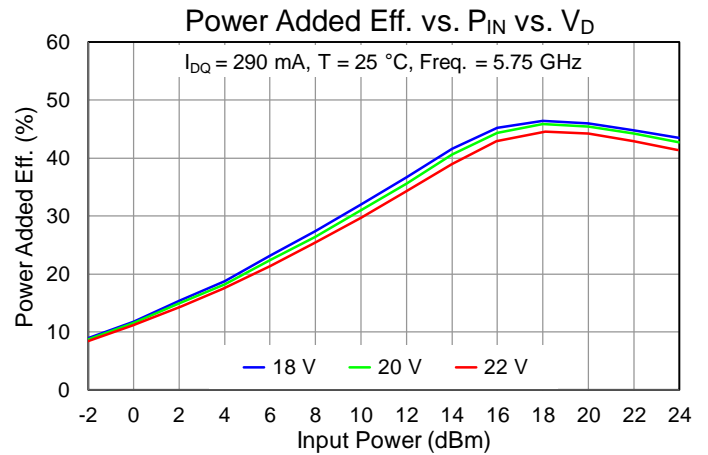
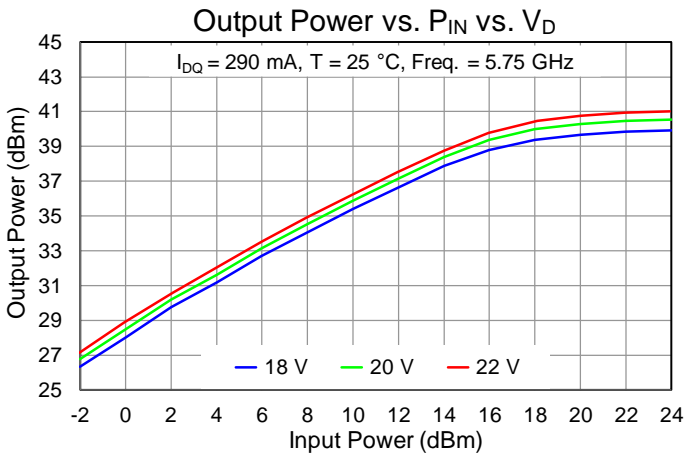

Performance Plots – Large Signal

Test conditions unless otherwise noted: $V_D = 22\text{ V}$, $I_{DQ} = 290\text{ mA}$, CW input power, $T = +25\text{ }^\circ\text{C}$

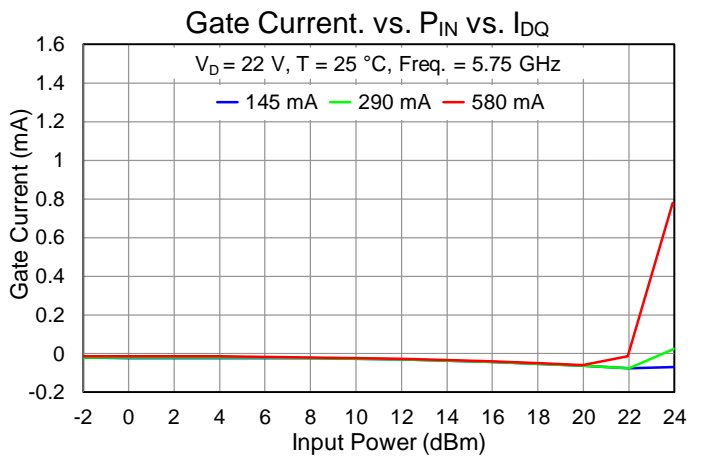
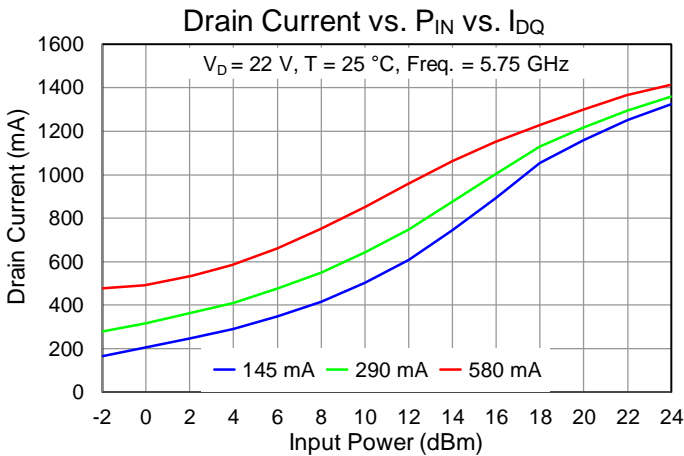
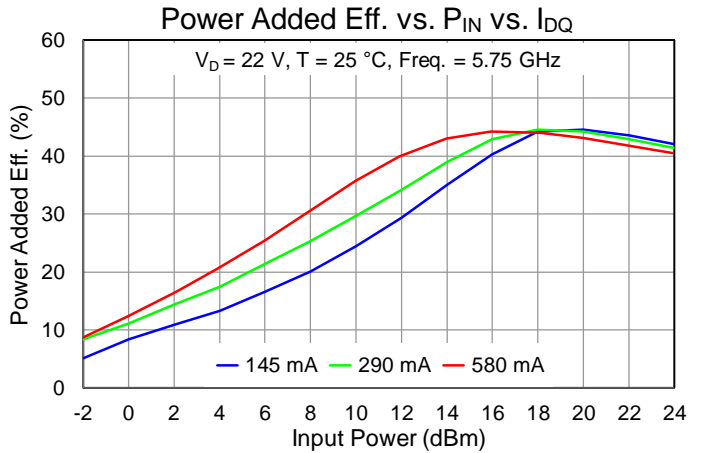
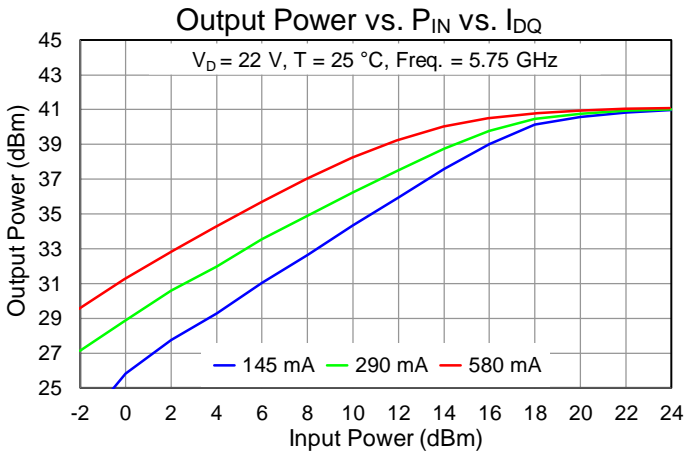

Performance Plots – Linearity

Test conditions unless otherwise noted: $V_D = 22\text{ V}$, $I_{DQ} = 290\text{ mA}$, CW input power, $T = +25^\circ\text{C}$, Freq. = 5.7 GHz, $\Delta F = 10\text{ MHz}$

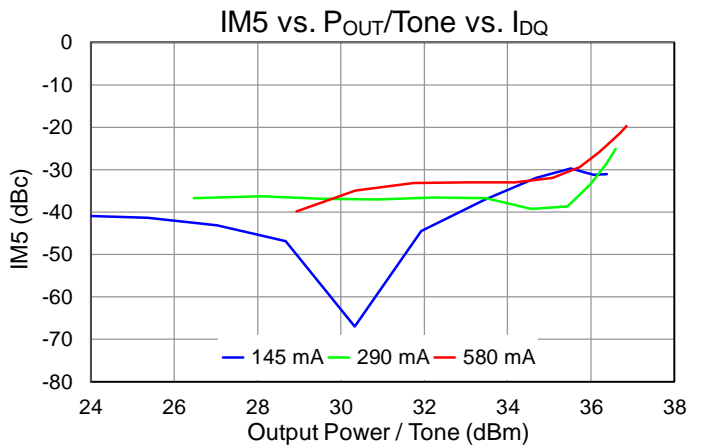
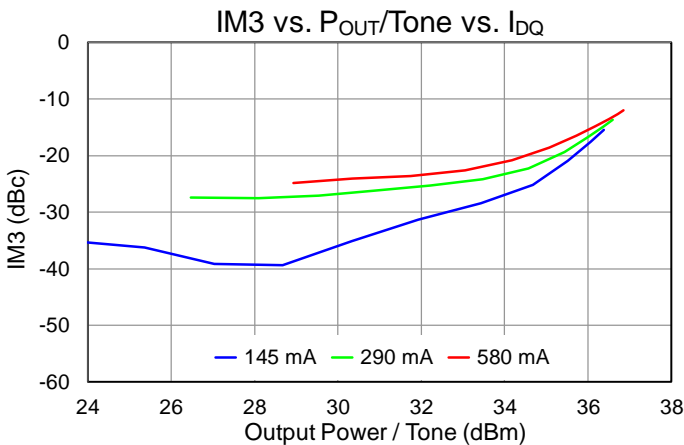
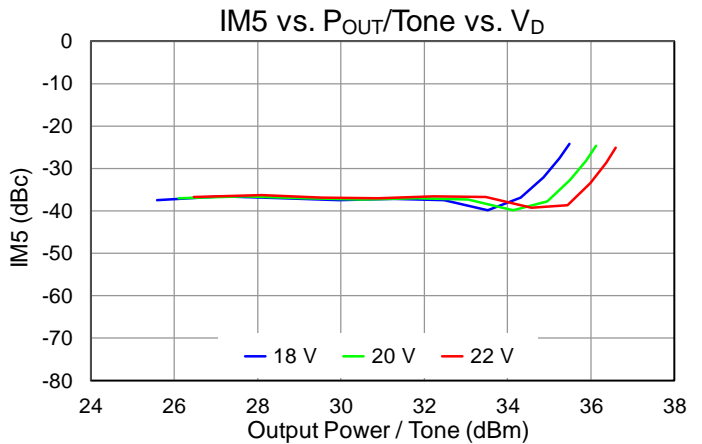
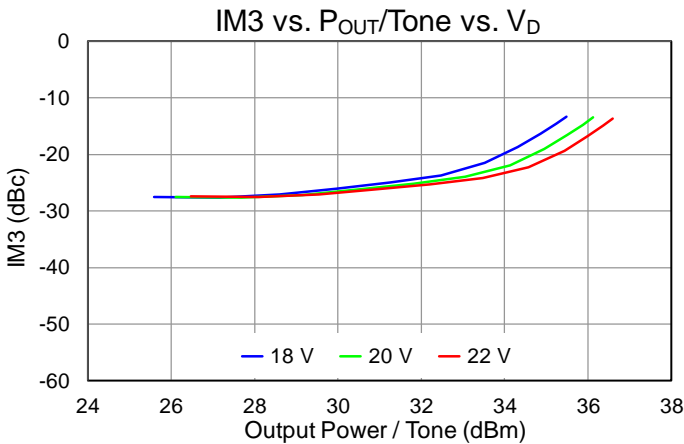
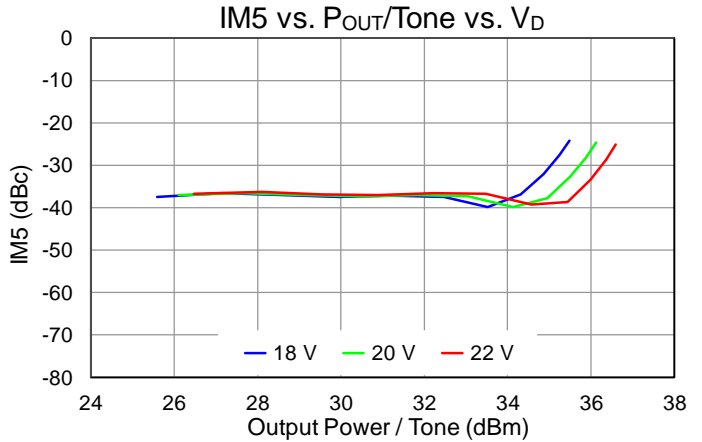
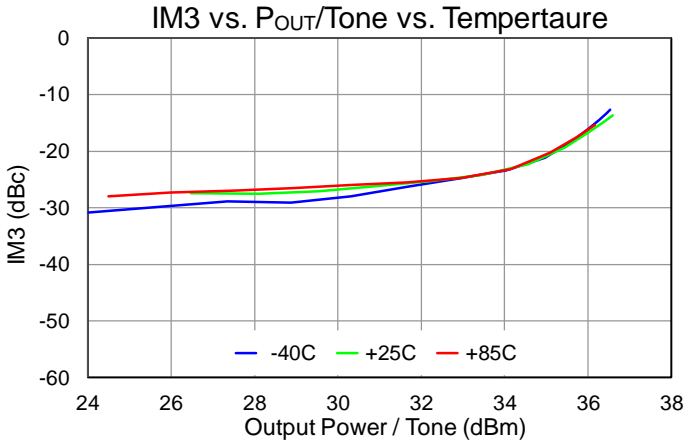

Performance Plots – Harmonics

Test conditions unless otherwise noted: $V_D = 20\text{ V}$, $I_{DQ} = 290\text{ mA}$, CW input power, $T = +25\text{ }^\circ\text{C}$, Freq. = 5.7 GHz

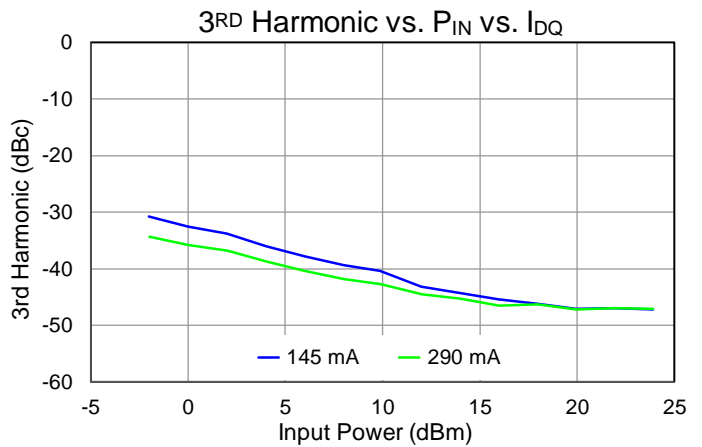
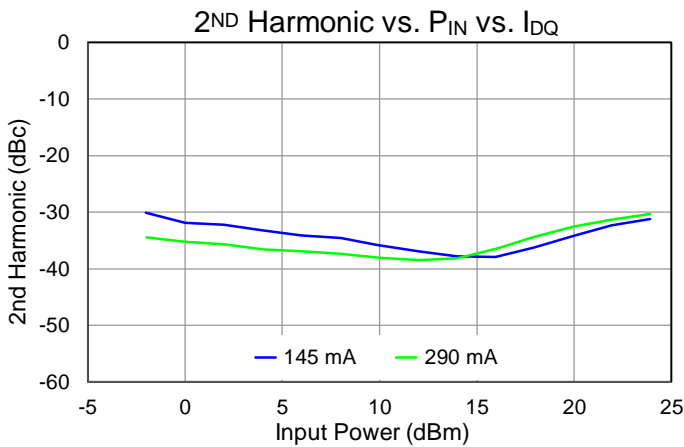
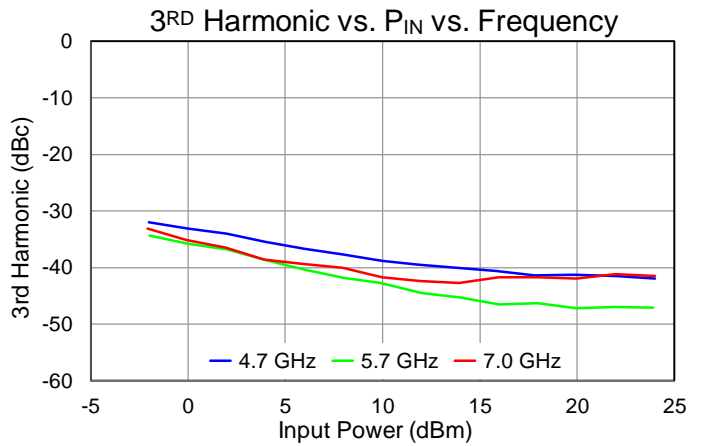
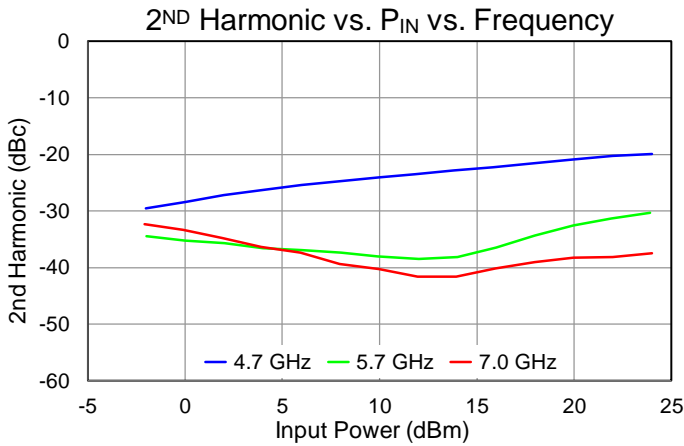
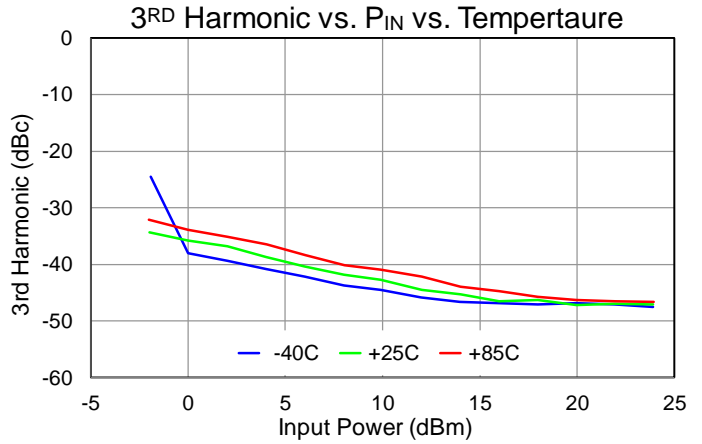
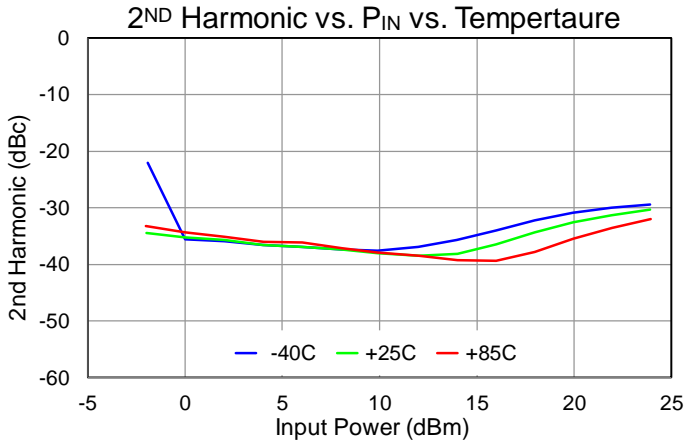

Performance Plots – Small Signal

Test conditions unless otherwise noted: $V_D = 22\text{ V}$, $I_{DQ} = 290\text{ mA}$, CW input power, $T = +25\text{ }^\circ\text{C}$

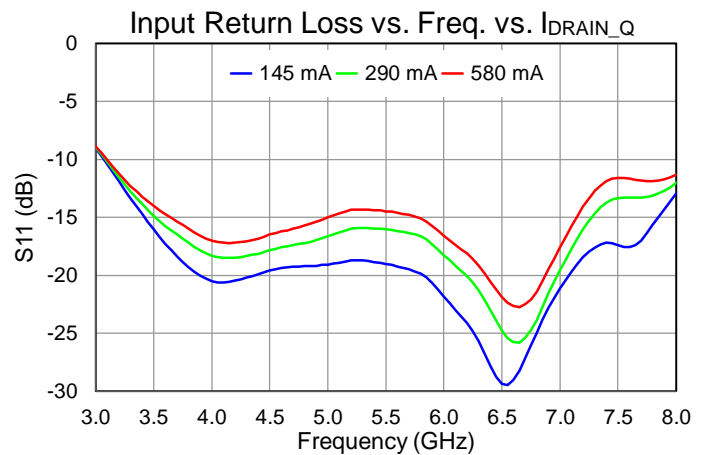
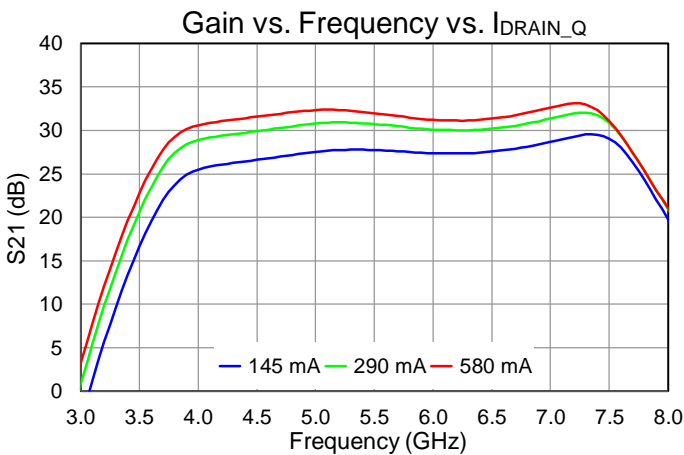
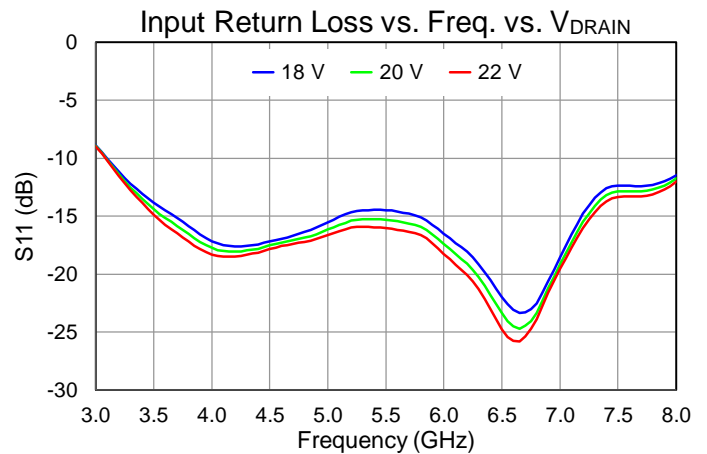
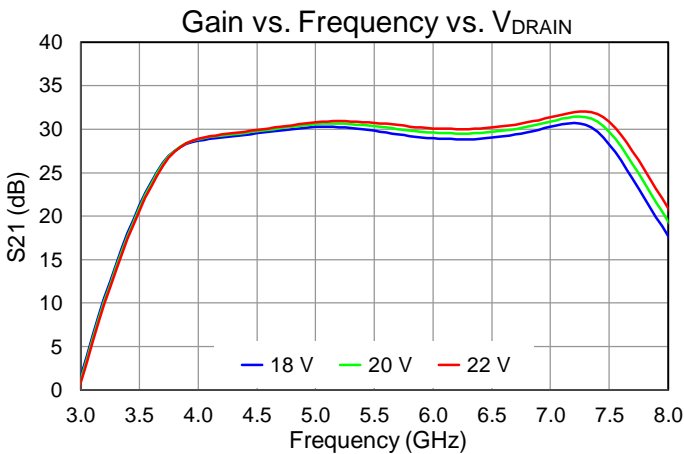
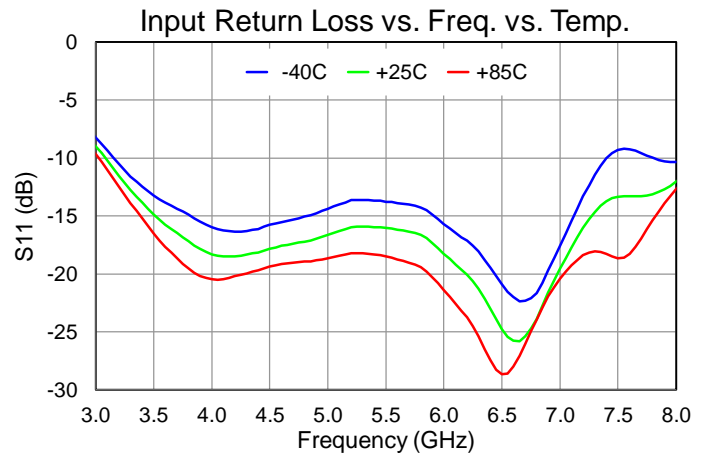
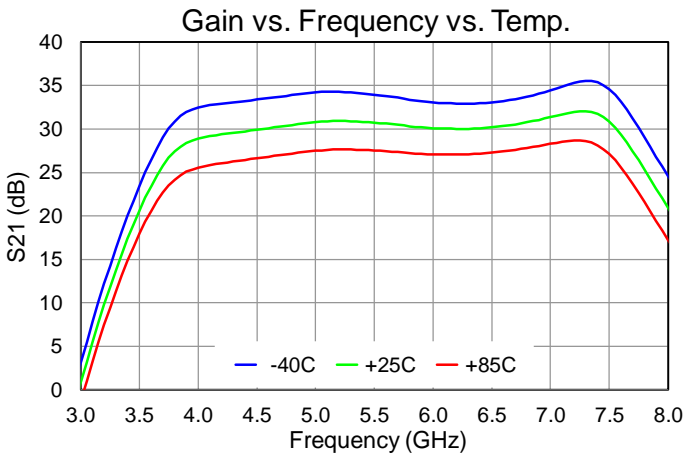

Performance Plots – Small Signal (CW)

Test conditions unless otherwise noted: $V_D = 22\text{ V}$, $I_{DQ} = 290\text{ mA}$, CW input power, $T = +25\text{ }^\circ\text{C}$

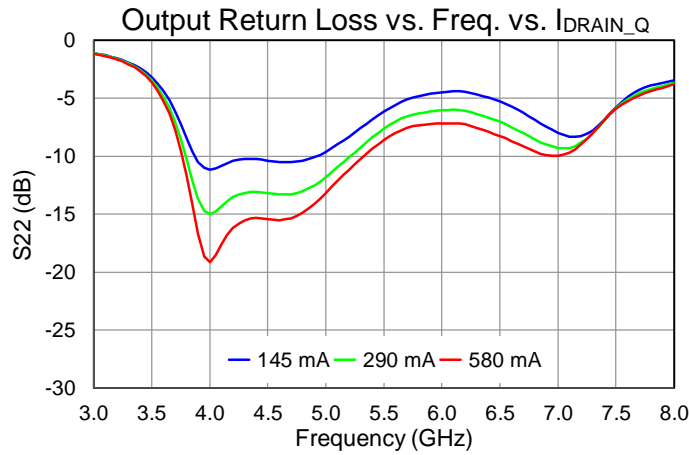
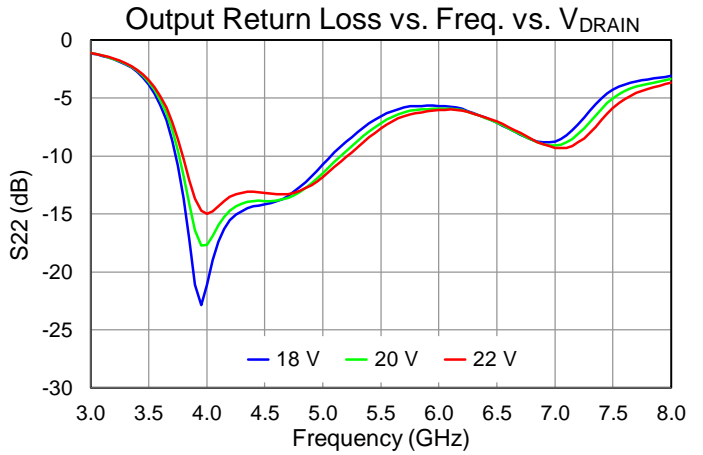
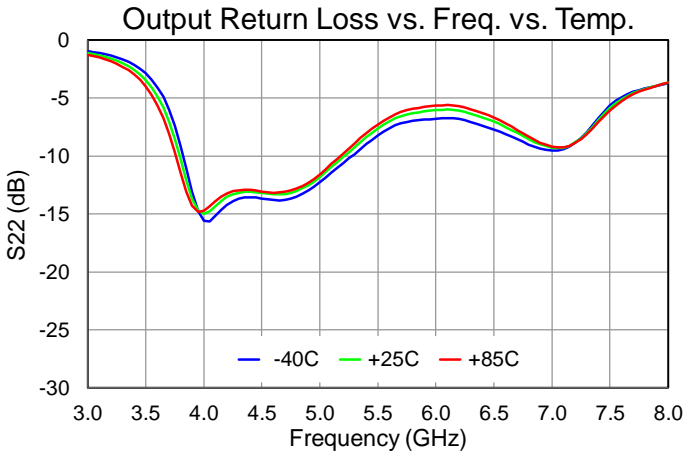

Thermal and Reliability Information

Parameter	Test Conditions	Value	Units
Thermal Resistance (θ_{JC}) ⁽¹⁾	$T_{base} = 85\text{ }^{\circ}\text{C}$, $V_D = 22\text{ V}$, $I_{DQ} = 290\text{ mA}$, $Freq = 6.5\text{ GHz}$, $I_{D_Drive} = 1.31\text{ A}$, $P_{IN} = 22\text{ dBm}$, $P_{OUT} = 40.5\text{ dBm}$, $P_{DISS} = 17.6\text{ W}$	3.86	$^{\circ}\text{C/W}$
Channel Temperature, T_{CH} (Under RF) ⁽²⁾		153	$^{\circ}\text{C}$
Thermal Resistance (θ_{JC}) ⁽¹⁾	$T_{base} = 85\text{ }^{\circ}\text{C}$, $V_D = 22\text{ V}$, $I_{DQ} = 290\text{ mA}$, $Freq = 6.5\text{ GHz}$, $I_{D_Drive} = 1.39\text{ A}$, $P_{IN} = 24\text{ dBm}$, $P_{OUT} = 40.7\text{ dBm}$, $P_{DISS} = 19.1\text{ W}$	3.87	$^{\circ}\text{C/W}$
Channel Temperature, T_{CH} (Under RF) ⁽²⁾		159	$^{\circ}\text{C}$

Notes:

1. Die mounted to 20 mil CuMo carrier plate with AuSn solder. Thermal resistance determined to the back of carrier (85 $^{\circ}\text{C}$).
2. Refer to the following document: [GaN Device Channel Temperature, Thermal Resistance, and Reliability Estimates](#)

Dissipated Power

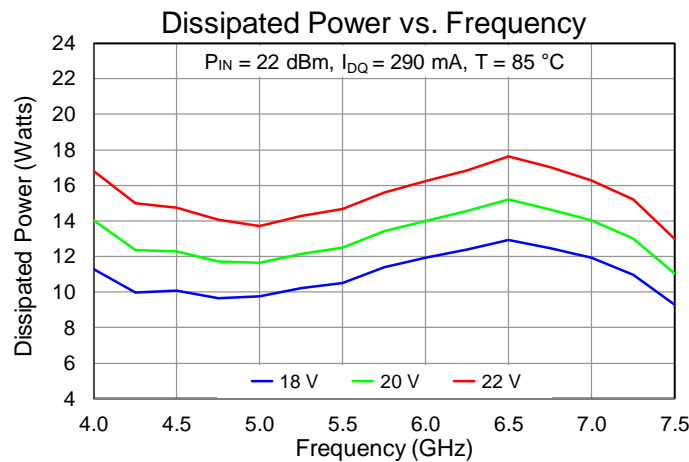

Applications Information and Pad Layout

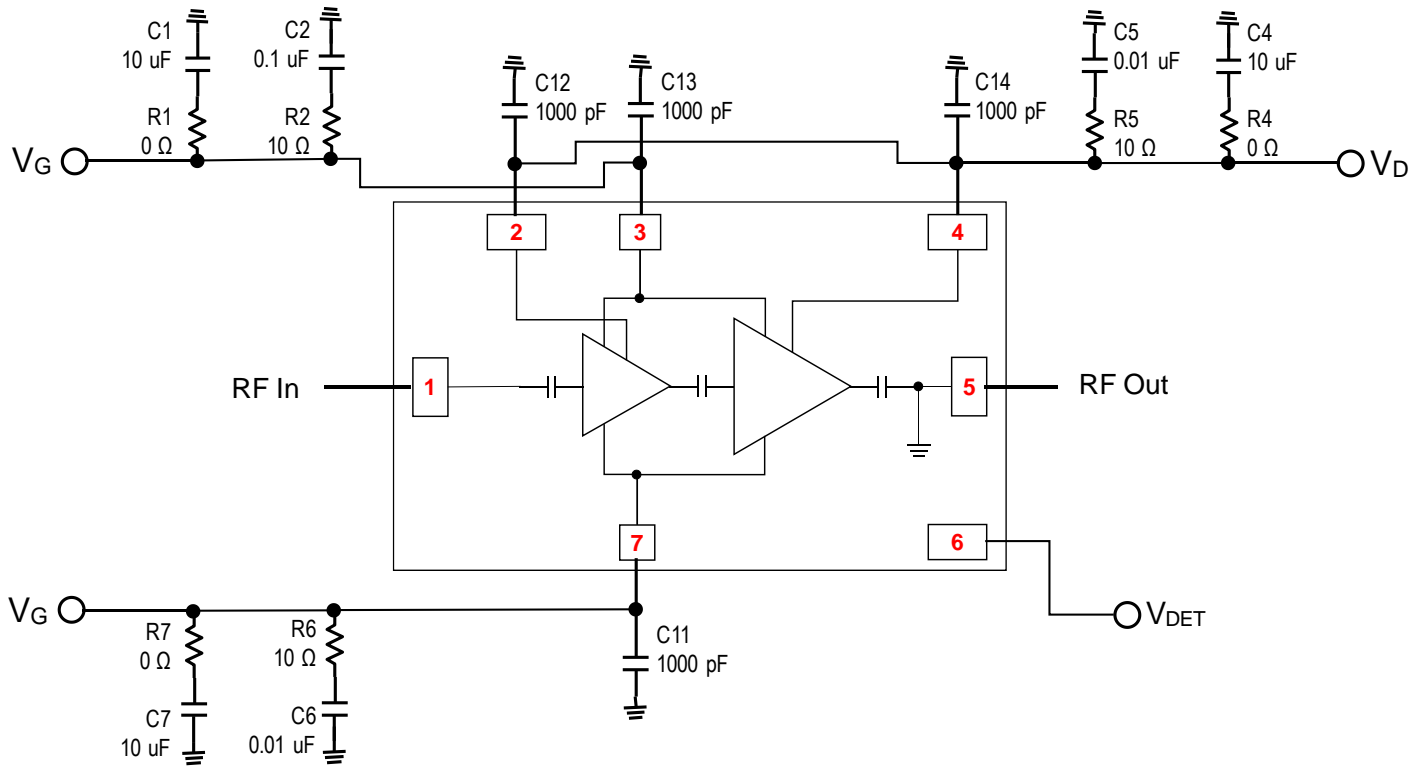

Bias-Up Procedure

1. Set I_D limit (CW) to 2000 mA, I_G limit to 20 mA
2. Set V_G to -5.0 V
4. Set V_D +22 V
5. Adjust V_G more positive until $I_{DQ} \approx 290$ mA ($V_G \sim -2.5$ V Typical)
6. Apply RF signal

Bias-Down Procedure

1. Turn off RF signal
2. Reduce V_G to -5.0 V. Ensure $I_{DQ} \sim 0$ mA
4. Set V_D to 0 V
5. Turn off V_D supply
6. Turn off V_G supply

Evaluation Board (EVB) Layout Assembly

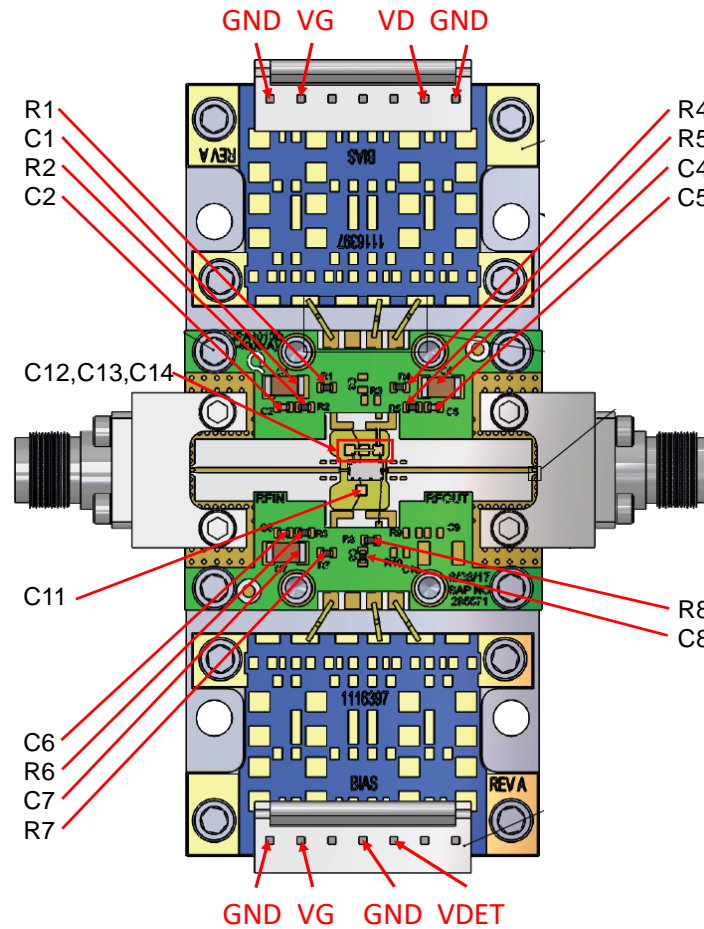

RF PCB is Rogers 4003C; dielectric is 8 mil thick, copper cladding is ½ oz. copper both sides, plated to 1 oz.

Bill of Materials

Reference Des.	Value	Description	Manuf.	Part Number
C1,C4,C7	10 uF	CAP, 10uF, 20%, 50V, 20%, X5R, 1206	Various	
C2,C5,C6	0.01 uF	CAP, 0.01uF, ±10%, 50V, X7R, 0402	Various	
C8	1000 pF	CAP, 1000pF, 10%, 100V, X7R, 0402	Various	
C11,C12,C13,C14	1000 pF	CAP, 1000pF, ±10% 50V, BORDER, SL	Various	
R1,R4,R7,R8	0 Ω	RES, 0 OHM, JMPR, 0402	Various	
R2,R5,R6	10 Ω	RES, 10 OHM, 5%, 0.1W, 0402	Various	
J1,J2		CONNECTOR, FEMALE, ENDLAUNCH, 1092-01A-5	Southwest Microwave	1092-01A-5

Mechanical Information and Bond Pad Description

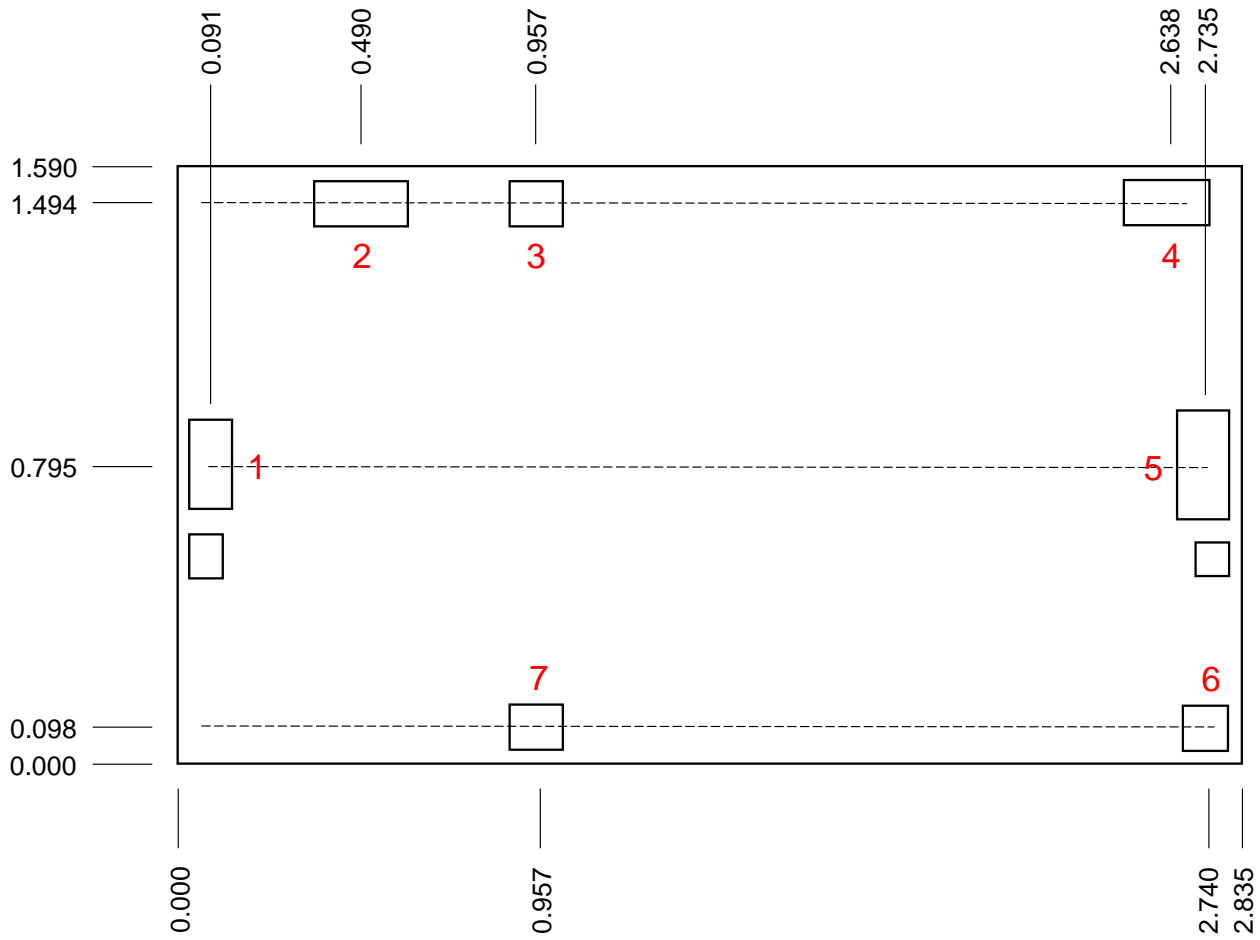

Units: millimeters
 Thickness: 0.100
 Die x,y size tolerance: ± 0.050
 Ground is backside of die

Bond Pad Description

Pad No.	Symbol	Pad Size (mm)	Description
1	RF IN	0.115 x 0.240	RF Input; matched to 50 Ω, DC blocked
2	V _{D1}	0.250 x 0.116	Drain voltage for stage 1. Bias network is required; see Application Circuit on page xx as an example.
3, 7	V _G	0.140 x 0.120	Gate voltage. Bias network is required; see Application Circuit on page xx as an example.
4	V _{D2}	0.230 x 0.120	Drain voltage for stage 2. Bias network is required; see Application Circuit on page xx as an example.
5	RF OUT	0.140 x 0.290	RF Output; matched to 50 Ω, DC blocked, DC grounded
6	V _{DET}	0.120 x 0.120	Output Power Detector Voltage

Assembly Notes

Component placement and adhesive attachment assembly notes:

- Vacuum pencils and/or vacuum collets are the preferred method of pick up.
- Air bridges must be avoided during placement.
- The force impact is critical during auto placement.

Reflow process assembly notes:

- Use AuSn (80/20) solder and limit exposure to temperatures above 300 °C to 3–4 minutes, maximum.
- An alloy station or conveyor furnace with reducing atmosphere should be used.
- Do not use any kind of flux.
- Coefficient of thermal expansion matching is critical for long-term reliability.
- Devices must be stored in a dry nitrogen atmosphere.

Interconnect process assembly notes:

- Thermosonic ball bonding is the preferred interconnect technique.
- Force, time, and ultrasonic are critical parameters.
- Aluminum wire should not be used.
- Devices with small pad sizes should be bonded with 0.0007-inch wire.

Handling Precautions

Parameter	Rating	Standard
ESD – Human Body Model (HBM)	Class 1A	ANSI/ESDA/JEDEC JS-001



Caution!
 ESD-Sensitive Device

Solderability

Use only AuSn (80/20) solder, and limit exposure to temperatures above 300 °C to 3–4 minutes, maximum.

RoHS Compliance

This part is compliant with 2011/65/EU RoHS directive (Restrictions on the Use of Certain Hazardous Substances in Electrical and Electronic Equipment) as amended by Directive 2015/863/EU.

This product also has the following attributes:

- Lead Free
- Halogen Free (Chlorine, Bromine)
- Antimony Free
- TBBP-A (C₁₅H₁₂Br₄O₂) Free
- PFOS Free
- SVHC Free

Contact Information

For the latest specifications, additional product information, worldwide sales and distribution locations:

Web: www.qorvo.com

Tel: 1-844-890-8163

Email: customer.support@qorvo.com

Important Notice

The information contained herein is believed to be reliable; however, Qorvo makes no warranties regarding the information contained herein and assumes no responsibility or liability whatsoever for the use of the information contained herein. All information contained herein is subject to change without notice. Customers should obtain and verify the latest relevant information before placing orders for Qorvo products. The information contained herein or any use of such information does not grant, explicitly or implicitly, to any party any patent rights, licenses, or any other intellectual property rights, whether with regard to such information itself or anything described by such information. **THIS INFORMATION DOES NOT CONSTITUTE A WARRANTY WITH RESPECT TO THE PRODUCTS DESCRIBED HEREIN, AND QORVO HEREBY DISCLAIMS ANY AND ALL WARRANTIES WITH RESPECT TO SUCH PRODUCTS WHETHER EXPRESS OR IMPLIED BY LAW, COURSE OF DEALING, COURSE OF PERFORMANCE, USAGE OF TRADE OR OTHERWISE, INCLUDING THE IMPLIED WARRANTIES OF MERCHANTABILITY AND FITNESS FOR A PARTICULAR PURPOSE.**

Without limiting the generality of the foregoing, Qorvo products are not warranted or authorized for use as critical components in medical, life-saving, or life-sustaining applications, or other applications where a failure would reasonably be expected to cause severe personal injury or death.

Copyright 2021 © Qorvo, Inc. | Qorvo is a registered trademark of Qorvo, Inc.