



LVTTL/TTL/CMOS-to-Differential LVECL/ ECL Translators

General Description

The MAX9360/MAX9361 are low-skew, single LVTTL/TTL/CMOS-to-differential LVECL/ECL translators designed for high-speed signal and clock driver applications. For interfacing to LVTTL/TTL/CMOS input signals, these devices operate over a 3.0V to 5.5V supply range, allowing high-performance clock or data distribution. For interfacing to differential LVECL/ECL output signals, these devices operate from a -2.25V to -5.5V supply.

The MAX9360 is a 3.3V LVTTL/CMOS-to-LVECL/ECL translator that operates at a typical speed of 3GHz. The MAX9361 is a 5V TTL/CMOS-to-LVECL/ECL translator that operates at a typical speed of 1.3GHz. Both devices can be used to drive either LVECL devices or standard ECL devices with a negative supply range of -2.25V to -5.5V.

The devices default to high if the input is disconnected, and feature ultra-low propagation delay 440ps for the MAX9360, 810ps for the MAX9361.

The MAX9360 is specified for operation from -40°C to +85°C in an 8-pin SO package, and 0°C to +85°C in a space-saving, 8-pin SOT23 package.

The MAX9361 is specified for operation from -40°C to +85°C for both 8-pin SO and SOT23 packages.

Applications

Clock/Data-Level Translation

Features

- ◆ Output High with Input Open
- ◆ -2.25V to -5.5V LVECL/ECL Operation
- ◆ ESD Protection >2kV (Human Body Model)
- ◆ 3.0V to 3.6V LVTTL/CMOS Operation (MAX9360)
 - Improved Second Source of the MC100EPT24
 - Low 13.8mA (typ) I_{EE} Supply Current
 - 440ps (typ) Propagation Delay
 - >300mV Output at 1GHz
- ◆ 4.5V to 5.5V TTL Operation (MAX9361)
 - Improved Second Source of the MC100ELT24
 - Low 6.6mA (typ) I_{EE} Supply Current
 - 810ps (typ) Propagation Delay
 - >300mV Output at 250MHz

Ordering Information

PART	TEMP RANGE	PIN-PACKAGE	TOP MARK
MAX9360UKA-T	0°C to +85°C	8 SOT23-8	AAJI
MAX9360ESA	-40°C to +85°C	8 SO	—
MAX9361EKA-T*	-40°C to +85°C	8 SOT23-8	AAJJ
MAX9361ESA*	-40°C to +85°C	8 SO	—

*Future product—contact factory for availability.

Pin Configurations

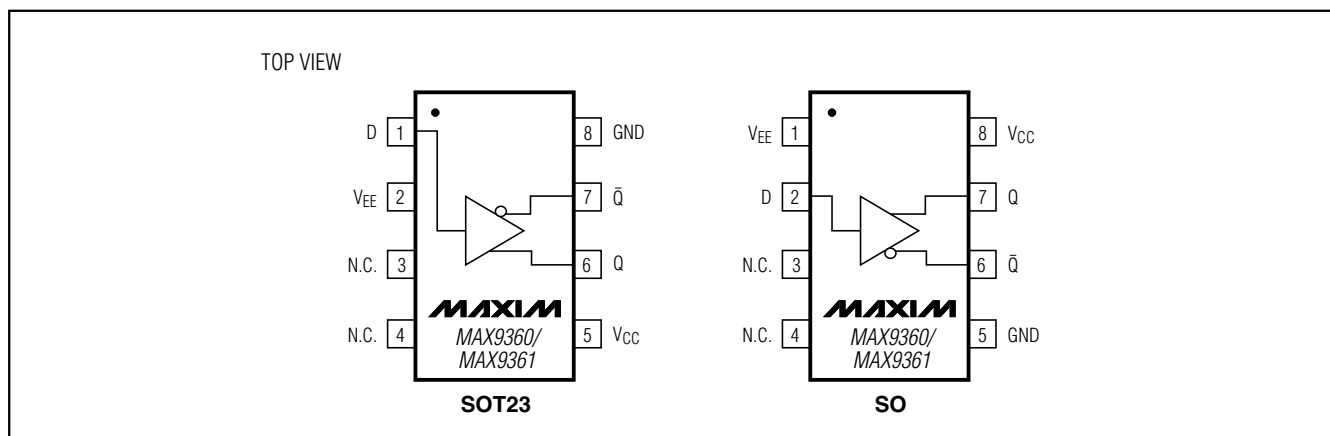

LVTTL/TTL/CMOS-to-Differential LVECL/ECL Translators

ABSOLUTE MAXIMUM RATINGS

V _{CC} to GND	-0.3V to +6V	Junction-to-Case Thermal Resistance	
V _{EE} to GND	-6V to 0	8-Pin SOT23	+80°C/W
D to GND	-0.3V to (V _{CC} + 0.3V)	8-Pin SO	+40°C/mW
Continuous Output Current	50mA	Continuous Power Dissipation (T _A = +70°C)	
Surge Output Current	100mA	8-Pin SOT23 (derate 8.9mW/°C above +70°C)	714mW
Junction-to-Ambient Thermal Resistance in Still Air		8-Pin SO (derate 5.9mW/°C above +70°C)	470mW
8-Pin SOT23	+112°C/W	Operating Temperature Range	-40°C to +85°C
8-Pin SO	+170°C/W	Junction Temperature	+150°C
Junction-to-Ambient Thermal Resistance with 500LFPM Airflow		Storage Temperature Range	-60°C to +150°C
8-Pin SOT23	+78°C/W	ESD Protection	
8-Pin SO	+99°C/W	Human Body Model (D, Q, \bar{Q})	>2kV
		Soldering Temperature (10s)	+300°C

Stresses beyond those listed under "Absolute Maximum Ratings" may cause permanent damage to the device. These are stress ratings only, and functional operation of the device at these or any other conditions beyond those indicated in the operational sections of the specifications is not implied. Exposure to absolute maximum rating conditions for extended periods may affect device reliability.

DC ELECTRICAL CHARACTERISTICS—MAX9360

(V_{CC} = 3.0V to 3.6V, V_{EE} = -2.25V to -5.5V, GND = 0, outputs terminated with 50Ω ±1% to -2.0V. Typical values are at V_{CC} = 3.3V, V_{IH} = 2.0V, V_{IL} = 0.8V, unless otherwise noted.) (Notes 1, 2, 3)

PARAMETER	SYMBOL	CONDITIONS	0°C (SOT23) -40°C (SO)			+25°C			+85°C			UNITS	
			MIN	TYP	MAX	MIN	TYP	MAX	MIN	TYP	MAX		
LVTTL INPUT (D)													
Input High Current	I _{IH}	V _{IN} = 2.7V			-20			-20			-20	μA	
		V _{IN} = V _{CC}			±10			±10			±10		
Input Low Current	I _{IL}	V _{IN} = 0.5V			-51	-200		-60	-200		-67	-200	μA
Input Clamp Voltage	V _{IK}	I _{IIN} = -18mA				-1.2			-1.2			-1.2	V
Input High Voltage	V _{IH}		2.0	1.4			2.0	1.4			2.0	1.4	V
Input Low Voltage	V _{IL}				0.8			1.4	0.8			0.8	V
LVECL/ECL OUTPUTS (Q, \bar{Q})													
Output High Voltage	V _{OH}		-1.145	-0.885	-1.145	-0.885	-1.145	-0.885	-1.145	-0.885	-1.145	-0.885	V
Output Low Voltage	V _{OL}		-1.935	-1.625	-1.935	-1.625	-1.935	-1.625	-1.935	-1.625	-1.935	-1.625	V
Differential Output Swing (V _{OH} - V _{OL})	V _{OH} - V _{OL}		550		550		550		550		550		mV
Power-Supply Current	I _{CC}	(Note 4)		4.3	7.0		5.0	7.0		5.6	7.0		mA
Internal Chip Current	I _{EE}	(Note 4)		12.3	20		13.8	20		15.2	20		mA

LVTTTL/TTL/CMOS-to-Differential LVECL/ ECL Translators

DC ELECTRICAL CHARACTERISTICS—MAX9361

($V_{CC} = 4.5V$ to $5.5V$, $V_{EE} = -2.25V$ to $-5.5V$, $GND = 0$, outputs terminated with $50\Omega \pm 1\%$ to $-2.0V$. Typical values are at $V_{CC} = 5V$, $V_{IH} = 2.0V$, $V_{IL} = 0.8V$, unless otherwise noted.) (Notes 1, 2, 3)

PARAMETER	SYMBOL	CONDITIONS	-40°C (SO)			+25°C			+85°C			UNITS							
			MIN	TYP	MAX	MIN	TYP	MAX	MIN	TYP	MAX								
TTL INPUT (D)																			
Input High Current	I_{IH}	$V_{IN} = 2.7V$			-30			-30			-30	μA							
		$V_{IN} = V_{CC}$			+10			+10			+10								
Input Low Current	I_{IL}	$V_{IN} = 0.5V$			-55			-200			-61			-200	μA				
Input Clamp Voltage	V_{IK}	$I_{IN} = -18mA$						-1.2						-1.2	V				
Input High Voltage	V_{IH}				2.0			2.0			2.0			2.0	V				
Input Low Voltage	V_{IL}							0.8			0.8			0.8	V				
LVECL/ECL OUTPUTS (Q, \bar{Q})																			
Output High Voltage	V_{OH}				-1.025			-0.88			-1.025			-0.88	-1.025			-0.88	V
Output Low Voltage	V_{OL}				-1.83			-1.555			-1.81			-1.62	-1.81			-1.62	V
Differential Output Swing ($V_{OH} - V_{OL}$)	$V_{OH} - V_{OL}$				550		640				550		689		550		695		mV
POWER SUPPLY																			
Power-Supply Current	I_{CC}	(Note 4)			2.5		7.0				2.9		7.0		3.3		7.0		mA
Internal Chip Current	I_{EE}	(Note 4)			5.8		20				6.6		20		7.2		20		mA

MAX9360/MAX9361

LVTTTL/TTL/CMOS-to-Differential LVECL/ ECL Translators

AC ELECTRICAL CHARACTERISTICS—MAX9360

($V_{CC} = 3.0V$ to $3.6V$, $V_{EE} = -2.25V$ to $-5.5V$, $GND = 0$, outputs terminated with $50\Omega \pm 1\%$ to $-2.0V$, input frequency = $1.0GHz$, input transition time = $125ps$ (20% to 80%). Typical values are at $V_{CC} = 3.3V$, $V_{IH} = 2.0V$, $V_{IL} = 0.8V$, unless otherwise noted.) (Note 5)

PARAMETER	SYMBOL	CONDITIONS	0°C (SOT23) -40°C (SO)			+25°C			+85°C			UNITS
			MIN	TYP	MAX	MIN	TYP	MAX	MIN	TYP	MAX	
Maximum Toggle Frequency	f_{MAX}	$V_{OH} - V_{OL} \geq 300mV$	1.0	3.0		1.0	3.0		1.0	3.0		GHz
		$V_{OH} - V_{OL} \geq 500mV$	0.85	1.5		0.85	1.5		0.85	1.5		
Input-to-Output Propagation Delay	t_{PLHD} , t_{PHLD}	Figure 1	300		800	300		800	300		800	ps
Output Rise/Fall Time	t_R , t_F	Figure 1	70	97	150	80	105	150	100	122	150	ps
Added Deterministic Jitter (Note 6)	t_{DJ}	2Gbps $2^{23} - 1$ PRBS pattern		43	70		43	70		43	70	ps(P-P)
Added Random Jitter (Note 6)	t_{RJ}	1.0GHz clock pattern		1.4	3.0		1.5	3.0		1.5	3.0	ps(RMS)

AC ELECTRICAL CHARACTERISTICS—MAX9361

($V_{CC} = 4.5V$ to $5.5V$, $V_{EE} = -2.25V$ to $-5.5V$, $GND = 0$, outputs terminated with $50\Omega \pm 1\%$ to $-2.0V$, input frequency = $100MHz$, input transition time = $125ps$ (20% to 80%). Typical values are at $V_{CC} = 5.0V$, $V_{IH} = 2.0V$, $V_{IL} = 0.8V$, unless otherwise noted.) (Note 5)

PARAMETER	SYMBOL	CONDITIONS	-40°C			+25°C			+85°C			UNITS
			MIN	TYP	MAX	MIN	TYP	MAX	MIN	TYP	MAX	
Maximum Toggle Frequency	f_{MAX}	$V_{OH} - V_{OL} \geq 300mV$	250	1300		250	1300		250	1300		MHz
		$V_{OH} - V_{OL} \geq 500mV$	150	400		150	400		150	400		
Input-to-Output Propagation Delay	t_{PLHD} , t_{PHLD}	Figure 1	500	780	1000	600	810	1100	700	820	1200	ps
Output Rise/Fall Time	t_R , t_F	Figure 1	250	414	1000	250	428	1000	250	453	1000	ps
Added Deterministic Jitter (Note 6)	t_{DJ}	200Mbps $2^{23} - 1$ PRBS pattern		46	100		46	100		49	100	ps(P-P)
Added Random Jitter (Note 6)	t_{RJ}	100MHz clock pattern		2	10		3	10		3	10	ps(RMS)

Note 1: Measurements are made with the device in thermal equilibrium.

Note 2: Current into a pin is defined as positive. Current out of a pin is defined as negative.

Note 3: DC parameters are production tested at +25°C. DC limits are guaranteed by design and characterization over the full operating temperature range.

Note 4: All pins are open except V_{CC} , V_{EE} , and GND .

Note 5: Guaranteed by design and characterization. Limits are set to ± 6 sigma.

Note 6: Device jitter added to the input signal.

LVTTL/TTL/CMOS-to-Differential LVECL/ ECL Translators

Typical Operating Characteristics

(MAX9360: $V_{CC} = 3.3V$ and $V_{EE} = -5V$, $V_{IH} = 2.0V$, $V_{IL} = 0.8V$, $T_A = +25^\circ C$, outputs terminated with 50Ω to $-2V$, input frequency = $1GHz$, input transition time = $125ps$ (20% to 80%), unless otherwise noted.)

MAX9360/MAX9361

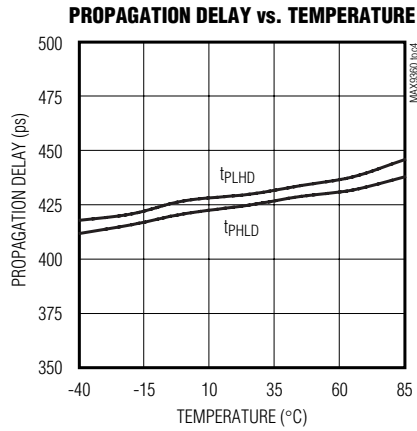
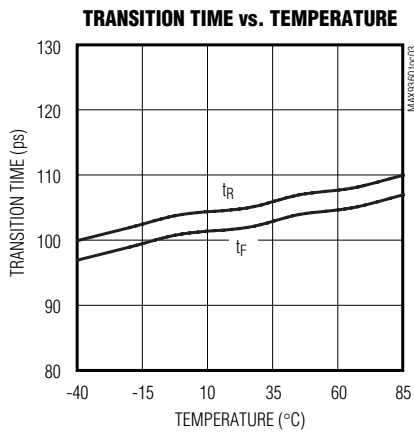
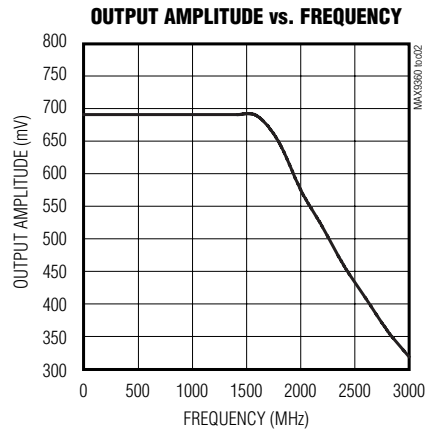
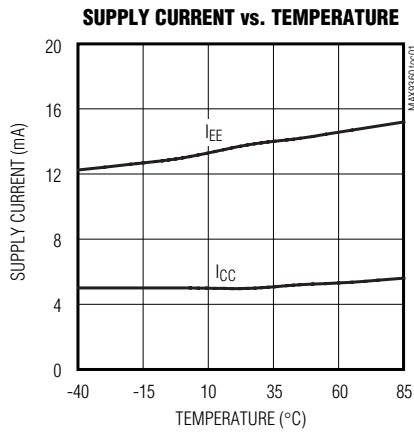

LVTTTL/TTL/CMOS-to-Differential LVECL/ECL Translators

Pin Description

PIN		NAME	FUNCTION
SO	SOT23		
1	2	V _{EE}	Negative Supply Voltage. Bypass V _{EE} to GND with 0.1μF and 0.01μF ceramic capacitors. Place the capacitors as close to the device as possible with the smaller value capacitor closest to the device.
2	1	D	LVTTTL/CMOS Input for MAX9360. TTL/CMOS input for MAX9361.
3, 4	3, 4	N.C.	No Connect. Connect to GND.
5	8	GND	Ground
6	7	\bar{Q}	Inverting Differential LVECL/ECL Output. Typically terminate with 50Ω resistor to -2V.
7	6	Q	Noninverting Differential LVECL/ECL Output. Typically terminate with 50Ω resistor to -2V.
8	5	V _{CC}	Positive Supply Voltage. Bypass V _{CC} to GND with 0.1μF and 0.01μF ceramic capacitors. Place the capacitors as close to the device as possible with the smaller value capacitor closest to the device.

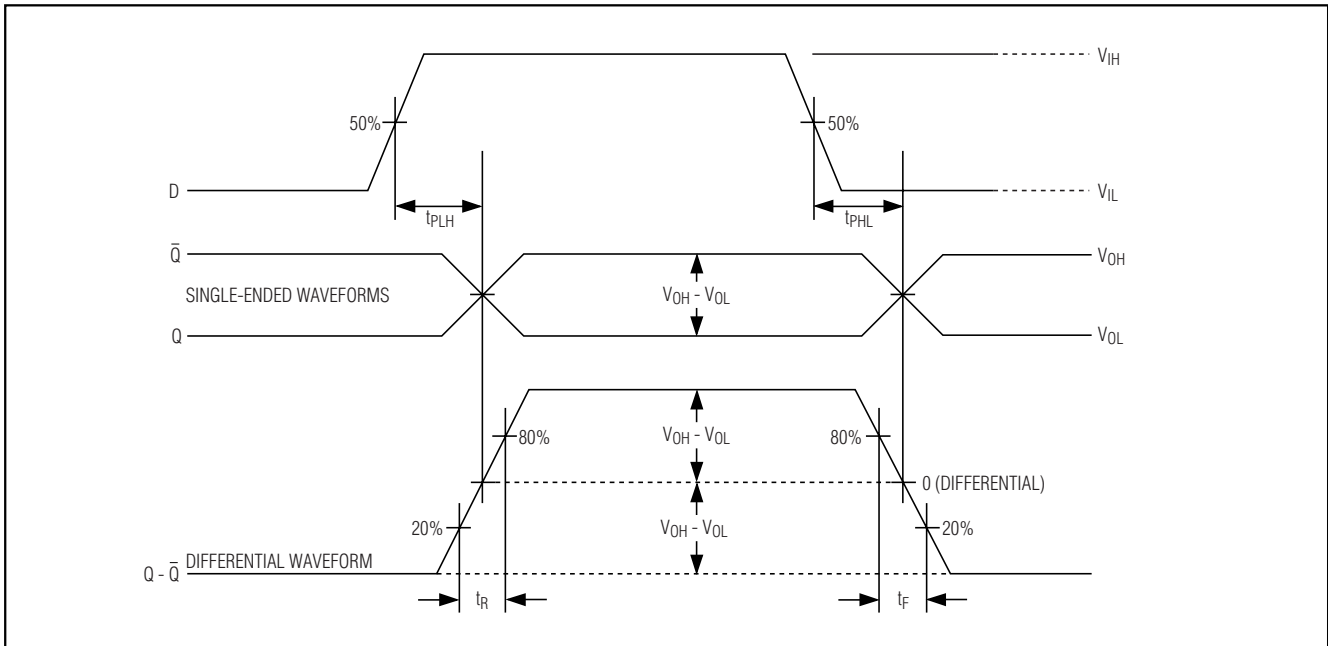

Figure 1. Input-to-Output Propagation Delay and Transition Timing Diagram

LVTTL/TTL/CMOS-to-Differential LVECL/ECL Translators

MAX9360/MAX9361

Detailed Description

The MAX9360/MAX9361 are low-skew, single LVTTL/CMOS/TTL-to-differential LVECL/ECL translators designed for high-speed signal and clock driver applications. For interfacing to LVTTL/TTL/CMOS input signals, these devices operate over a 3.0V to 5.5V supply range, allowing high-performance clock or data distribution in systems with a nominal 3.3V or 5.0V supply. For interfacing to differential LVECL/ECL output signals, these devices operate from a -2.25V to -5.5V supply.

The MAX9360 is a 3.3V LVTTL/CMOS-to-LVECL/ECL translator that operates at typical speeds of 3GHz. The MAX9361 is a 5V TTL/CMOS-to-LVECL/ECL translator that operates at typical speeds of 1.3GHz. Both devices can be used to drive either LVECL devices or standard ECL devices with a negative supply range of -2.25V to -5.5V.

Input

The MAX9360/MAX9361 inputs accept standard LVTTL/TTL/CMOS levels. The input has pullup circuitry that drives the outputs to a differential high if the inputs are open.

Differential Output

Output levels are referenced to GND and are considered ECL or LVECL, depending on the level of the V_{EE} supply. With GND connected to 0 and V_{EE} at -4.2V to -5.5V, the outputs are ECL. The outputs are LVECL when GND is connected to 0 and V_{EE} is at -2.25V to -3.8V.

Applications Information

Supply Bypassing

Bypass V_{CC} and V_{EE} to ground with high-frequency surface-mount ceramic 0.1 μ F and 0.01 μ F capacitors in parallel as close to the device as possible, with the 0.01 μ F value capacitor closest to the device. Use multiple parallel vias for low inductance.

Traces

Input and output trace characteristics affect the performance of the MAX9360/MAX9361. Connect each signal of a differential output to a 50 Ω characteristic impedance trace. Minimize the number of vias to prevent impedance discontinuities. Reduce reflections by maintaining the 50 Ω characteristic impedance through connectors and across cables. Reduce skew within a differential pair by matching the electrical length of the traces.

On the MAX9360, if the input edge rate approaches the electrical length of the interconnect, then controlled-impedance transmission lines should be used for the input traces.

Output Termination

Terminate outputs through 50 Ω to -2V or use an equivalent Thevenin termination. Terminate both outputs and use the same termination on each for the lowest output-to-output skew. When a single-ended signal is taken from a differential output, terminate both outputs. For example, if Q is used as a single-ended output, terminate both Q and \bar{Q} .

Ensure that the output currents do not exceed the continuous safe output current limit or surge output current limit as specified in the *Absolute Maximum Ratings* table. Under all operating conditions, the device's total thermal limits should be observed.

Chip Information

TRANSISTOR COUNT: 330

PROCESS: Bipolar

LVTTL/TTL/CMOS-to-Differential LVECL/ ECL Translators

Package Information

SYMBOL	MIN	MAX
A	0.90	1.45
A1	0.00	0.15
A2	0.90	1.30
b	0.28	0.45
C	0.09	0.20
D	2.80	3.00
E	2.60	3.00
E1	1.50	1.75
L	0.10	0.60
e	0.65 ref	
e1	1.95 ref	
α	0°	10°

NOTE:
 1. ALL DIMENSIONS ARE IN MILLIMETERS.
 2. FOOT LENGTH MEASURED REFERENCE TO FLAT FOOT SURFACE PARALLEL TO DATUM "A".
 3. PACKAGE OUTLINE EXCLUSIVE OF MOLD FLASH & METAL BURR.
 4. PACKAGE OUTLINE INCLUSIVE OF SOLDER PLATING.
 5. EIAJ REF. NUMBER SC-74 (6 LEAD VERSION)
 6. COPLANARITY 4 MILS. MAX.
 7. PIN 1 I.D. DOT IS 0.3 MM ϕ MIN. LOCATED ABOVE PIN 1.
 8. MEETS JEDEC MO178.

MAXIM
 PROPRIETARY INFORMATION
 TITLE: PACKAGE OUTLINE, SOT-23, 8L
 APPROVAL: _____ DOCUMENT CONTROL NO. 21-0078 REV C 1/1

SOT23, 8LEPS

LVTTL/TTL/CMOS-to-Differential LVECL/ ECL Translators

Package Information (continued)

MAX9360/MAX9361

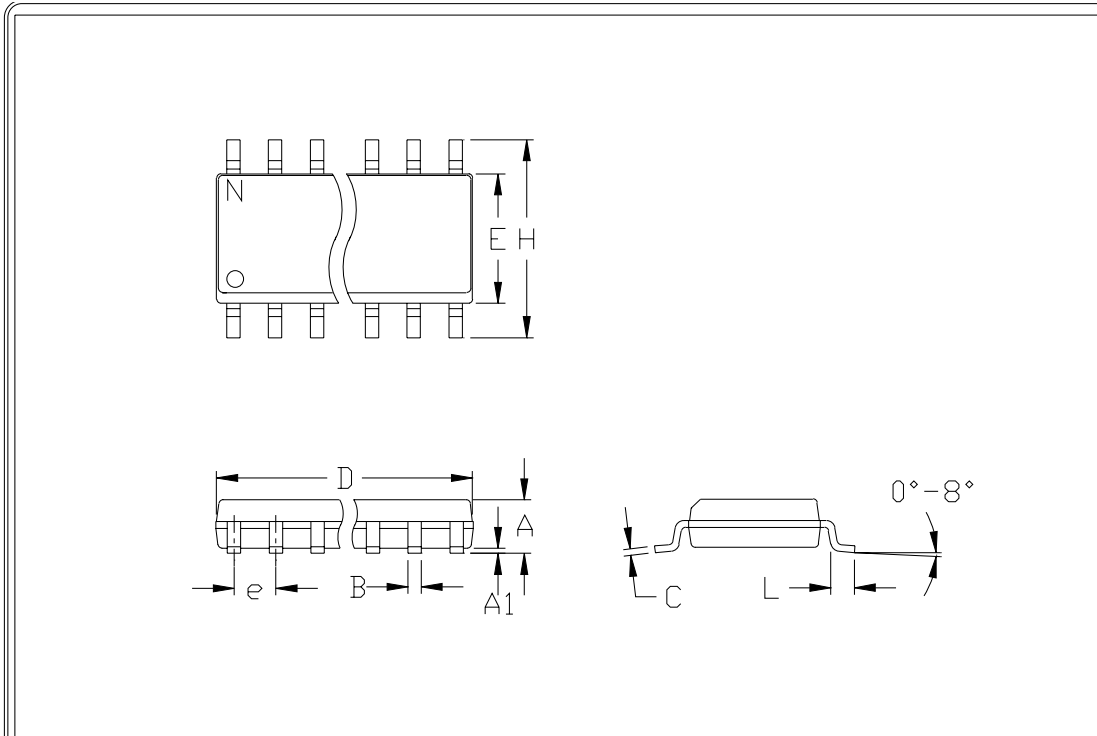

	INCHES		MILLIMETERS	
	MIN	MAX	MIN	MAX
A	0.053	0.069	1.35	1.75
A1	0.004	0.010	0.10	0.25
B	0.014	0.019	0.35	0.49
C	0.007	0.010	0.19	0.25
e	0.050		1.27	
E	0.150	0.157	3.80	4.00
H	0.228	0.244	5.80	6.20
h	0.010	0.020	0.25	0.50
L	0.016	0.050	0.40	1.27

	INCHES		MILLIMETERS		N	MS012
	MIN	MAX	MIN	MAX		
D	0.189	0.197	4.80	5.00	8	A
D	0.337	0.344	8.55	8.75	14	B
D	0.386	0.394	9.80	10.00	16	C

NOTES:

1. D&E DO NOT INCLUDE MOLD FLASH
2. MOLD FLASH OR PROTRUSIONS NOT TO EXCEED .15mm (.006")
3. LEADS TO BE COPLANAR WITHIN .102mm (.004")
4. CONTROLLING DIMENSION: MILLIMETER
5. MEETS JEDEC MS012-XX AS SHOWN IN ABOVE TABLE
6. N = NUMBER OF PINS



PACKAGE FAMILY OUTLINE: SOIC .150"
TITLE



21-0041 A
DOCUMENT CONTROL NUMBER REV

Maxim cannot assume responsibility for use of any circuitry other than circuitry entirely embodied in a Maxim product. No circuit patent licenses are implied. Maxim reserves the right to change the circuitry and specifications without notice at any time.

Maxim Integrated Products, 120 San Gabriel Drive, Sunnyvale, CA 94086 408-737-7600 _____ 9