

Am2902A

High-Speed Look-Ahead Carry Generator

DISTINCTIVE CHARACTERISTICS

- Provides look-ahead carries across a group of four Am2901 or Am2903 microprocessor ALU's
- Capability of multi-level look-ahead for high-speed arithmetic operation over large word lengths
- Typical carry propagation delay of 4.5ns

GENERAL DESCRIPTION

The Am2902A is a high-speed, look-ahead carry generator which accepts up to four pairs of carry propagate and carry generate signals and a carry input and provides anticipated carries across four groups of binary ALU's. The device also has carry propagate and carry generate outputs which may be used for further levels of look-ahead.

The Am2902A is generally used with the Am2901 bipolar microprocessor unit to provide look-ahead over word lengths of more than four bits. The look-ahead carry generator can be used with binary ALU's in an active LOW

or active HIGH input operand mode by reinterpreting the carry functions. The connections to and from the ALU to the look-ahead carry generator are identical in both cases.

The logic equations provided at the outputs are:

$$C_n + x = G_0 + P_0 C_n$$

$$C_n + y = G_1 + P_1 G_0 + P_1 P_0 C_n$$

$$C_n + z = G_2 + P_2 G_1 + P_2 P_1 G_0 + P_2 P_1 P_0 C_n$$

$$G = G_3 + P_3 G_2 + P_3 P_2 G_1 + P_3 P_2 P_1 G_0$$

$$P = P_3 P_2 P_1 P_0$$

5

BLOCK DIAGRAM

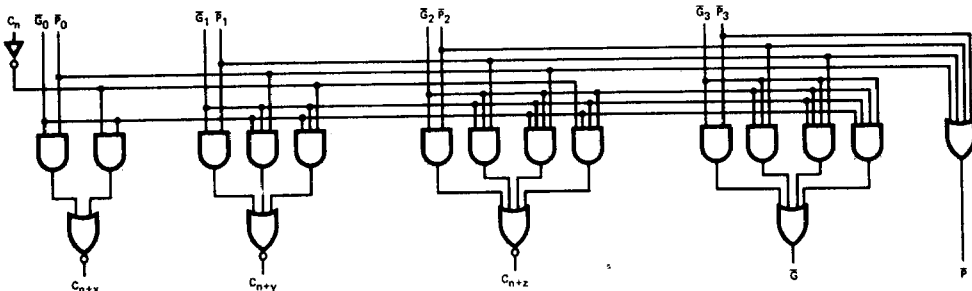

BD001680

RELATED PRODUCTS

Part No.	Description
Am2901	4-Bit Microprocessor Slice
Am2903	4-Bit Microprocessor Slice
Am29203	Improved 2903
Am29501	Multiport Pipelined Processor

CONNECTION DIAGRAM Top View

P-16, D-16

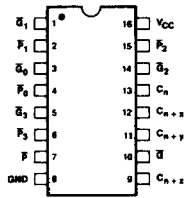

CD004010

L-20-1

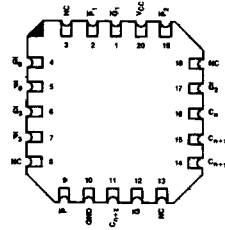

CD004000

F-16 pin configuration identical to D-16, P-16.
Note: Pin 1 is marked for orientation

LOGIC SYMBOL

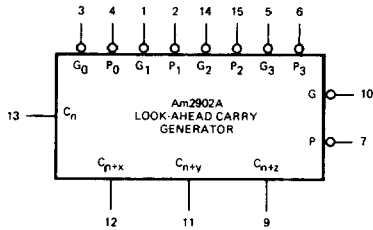

LS000850

METALLIZATION AND PAD LAYOUT

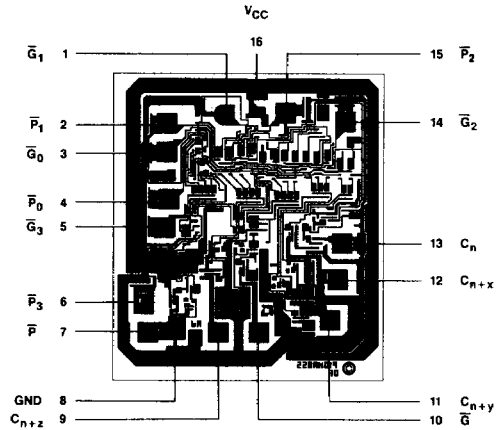

DIE SIZE 0.062" x 0.067"

ORDERING INFORMATION

AMD products are available in several packages and operating ranges. The order number is formed by a combination of the following: Device number, speed option (if applicable), package type, operating range and screening option (if desired).

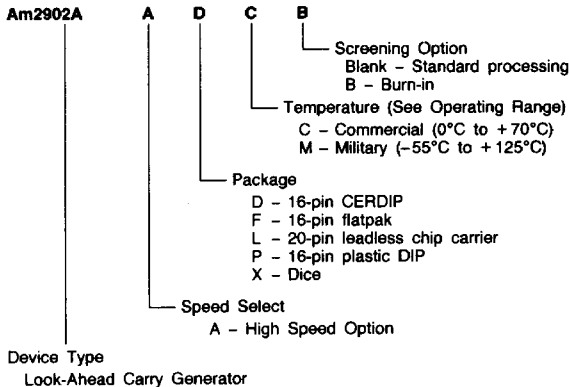

Valid Combinations	
Am2902A	PC DC, DCB, DM, DMB FM, FMB LC, LCB, LM, LMB XC, XM

Valid Combinations
Consult the AMD sales office in your area to determine if a device is currently available in the combination you wish.

PIN DESCRIPTION

Pin No.	Name	I/O	Description
13	C_n	I	Carry-in. The carry-in input to the look-ahead generator. Also the carry-in input to the nth Am2901 microprocessor ALU input.
12, 11, 9	C_{n+j}	O	Carry-out. (j = x, y, z). The carry-out output to be used at the carry-in inputs of the n + 1, n + 2 and n + 3 microprocessor ALU slices.
1-6, 14, 15	\bar{G}_i, \bar{P}_i	I	Generate and propagate inputs respectively (i = 0, 1, 2, 3). The carry generate and carry propagate inputs from the n, n + 1, n + 2 and n + 3 microprocessor ALU slices.
10, 7	\bar{G}, \bar{P}	O	Generate and propagate outputs respectively. The carry generate and carry propagate outputs that can be used with the next higher level of carry look-ahead if used.

TRUTH TABLE

Inputs								Outputs					
C_n	\bar{G}_0	\bar{P}_0	\bar{G}_1	\bar{P}_1	\bar{G}_2	\bar{P}_2	\bar{G}_3	\bar{P}_3	C_{n+x}	C_{n+y}	C_{n+z}	\bar{G}	\bar{P}
X	H	H							L				
L	H	X							L				
X	L	X							H				
H	X	L							H				
X	X	X	H	H					L				
X	H	H	H	X					L				
L	H	X	H	X					L				
X	X	X	L	X					H				
X	L	X	X	L					H				
H	X	L	X	L					H				
X	X	X	X	X	H	H				L			
X	X	X	H	H	H	X				L			
X	H	H	H	X	H	X				L			
H	H	X	H	X	H	X				H			
X	X	X	X	X	L	X				L			
X	X	X	L	X	X	L				L			
X	L	X	X	L	X	L				L			
L	X	L	X	L	X	L				L			
	H	X	X	X								H	
	X	H	X	X								H	
	X	X	H	X								H	
	X	X	X	H								H	
	L	L	L	L								L	

H = HIGH Voltage Level
 L = LOW Voltage Level
 X = Don't Care

APPLICATIONS

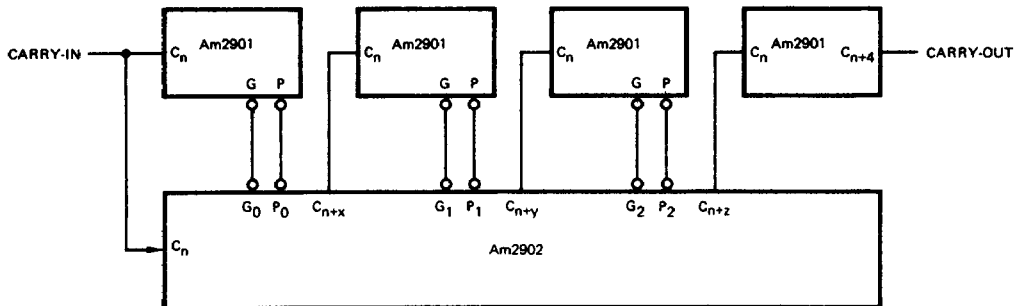

AF001331

16-BIT CARRY LOOK-AHEAD CONNECTION.

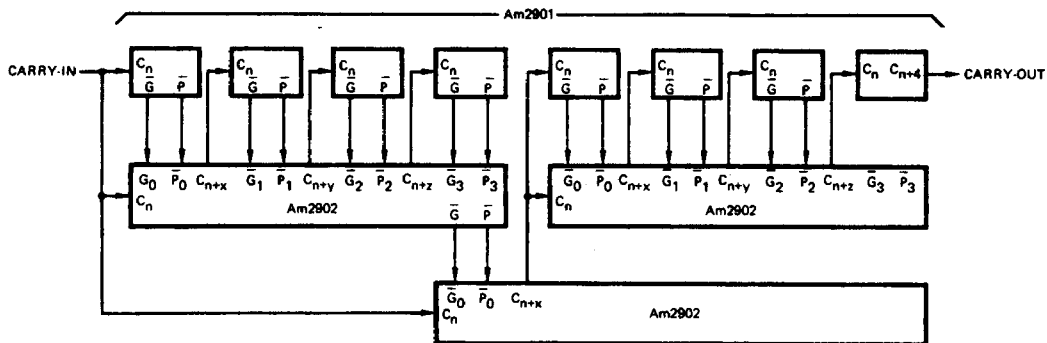

AF001321

32-BIT ALU, THREE LEVEL CARRY LOOK-AHEAD.

ABSOLUTE MAXIMUM RATINGS

Storage Temperature	-65°C to +150°C
(Ambient) Temperature with Applied Powers	-55°C to +125°C
Supply Voltage to Ground Potential Continuous	-0.5V to +7.0V
DC Voltage Applied to Outputs For High Output State	-0.5V to +V _{CC} max
DC Input Voltage	-0.5V to +5.5V
DC Output Current, Into Outputs	30mA
DC Input Current	-30mA to +5.0mA

Stresses above those listed under **ABSOLUTE MAXIMUM RATINGS** may cause permanent device failure. Functionality at or above these limits is not implied. Exposure to absolute maximum ratings for extended periods may affect device reliability.

OPERATING RANGES

Commercial (C) Devices Temperature	0°C to +70°C
Supply Voltage	+4.75V to +5.25V
Military (M) Devices Temperature	-55°C to +125°C
Supply Voltage	+4.5V to +5.5V

Operating ranges define those limits over which the functionality of the device is guaranteed.

DC CHARACTERISTICS over operating range unless otherwise specified

Parameters	Description	Test Conditions (Note 2)	Min	Typ (Note 1)	Max	Units	
V _{OH}	Output HIGH Voltage	V _{CC} = MIN, I _{OH} = -1mA V _{IN} = V _{IH} or V _{IL}	MIL	2.5	3.4		Volts
			COM	2.7	3.4		
V _{OL}	Output LOW Voltage	V _{CC} = MIN, I _{OL} = 20mA V _{IN} = V _{IH} or V _{IL}			0.5	Volts	
V _{IH}	Input HIGH Level	Guaranteed input logical HIGH voltage for all inputs	2.0			Volts	
V _{IL}	Input LOW Level	Guaranteed input logical LOW voltage for all inputs			0.8	Volts	
V _I	Input Clamp Voltage	V _{CC} = MIN, I _{IN} = -18mA			-1.2	Volts	
I _{IL}	Input LOW Current	V _{CC} = MAX, V _{IN} = 0.5V	C _n		-2	mA	
			P ₃		-4		
			P ₂		-6		
			P ₀ , P ₁ , G ₃		-8		
			G ₀ , G ₂		-14		
			G ₁		-16		
I _{IH}	Input HIGH Current	V _{CC} = MAX, V _{IN} = 2.7V	C _n		50	μA	
			P ₃		100		
			P ₂		150		
			P ₀ , P ₁ , G ₃		200		
			G ₀ , G ₂		350		
			G ₁		400		
I _I	Input HIGH Current	V _{CC} = MAX, V _{IN} = 5.5V			1.0	mA	
I _{SC}	Output Short Circuit (Note 3)	V _{CC} = MAX, V _{OUT} = 0.0V	-40		-100	mA	
I _{CC}	Power Supply Current	V _{CC} = MAX All Outputs LOW	MIL	69	99	mA	
			COM'L	69	109		
		V _{CC} = MAX All Outputs HIGH	MIL	35		mA	
			COM'L	35			

- Notes: 1. Typical limits are at V_{CC} = 5.0V, 25°C ambient and maximum loading.
 2. For conditions shown as MIN or MAX, use the appropriate value specified under Operating Ranges for the applicable device type.
 3. Not more than one output should be shorted at a time. Duration of the short circuit test should not exceed one second.

SWITCHING CHARACTERISTICS ($T_A = +25^\circ\text{C}$, $V_{CC} = 5.0\text{V}$)

Parameters	Description	Test Conditions	Min	Typ	Max	Units
t_{PLH}	C_n to C_{n+x} , C_{n+y} , or C_{n+z}	$C_L = 15\text{ pF}$ $R_L = 280\ \Omega$		6.5	10	ns
t_{PHL}				7	10.5	
t_{PLH}	\bar{P}_i or \bar{G}_i to C_{n+x} , C_{n+y} , or C_{n+z}			4.5	7	ns
t_{PHL}				4.5	7	
t_{PLH}	\bar{P}_i or \bar{G}_i to \bar{G}			5	7.5	ns
t_{PHL}				7	10.5	
t_{PLH}	\bar{P}_i to \bar{P}			4.5	6.5	ns
t_{PHL}				6.5	10	

SWITCHING CHARACTERISTICS over operating range unless otherwise specified*

Parameters	Description	Test Conditions	COMMERCIAL		MILITARY		Units
			Am2902A		Am2902A		
			Min	Max	Min	Max	
t_{PLH}	C_n to C_{n+x} , C_{n+y} or C_{n+z}	$C_L = 50\text{ pF}$ $R_L = 280\ \Omega$		13		15	ns
t_{PHL}				14		16.5	ns
t_{PLH}	\bar{P}_i or \bar{G}_i to C_{n+x} , C_{n+y} , or C_{n+z}			8		9.5	ns
t_{PHL}				9		11.5	ns
t_{PLH}	\bar{P}_i or \bar{G}_i to \bar{G}			12		16.5	ns
t_{PHL}				12		13.5	ns
t_{PLH}	\bar{P}_i to \bar{P}			9.5		11.5	ns
t_{PHL}				11		12	ns

*Switching Characteristics' performance over the operating temperature range is guaranteed by testing defined in Group A, Subgroup 9.