

Piezo Switch for Explosive Environments



PSE 16 EX

See below:

**Approvals and Compliances**

**Description**

- Piezo switch certified according to ATEX and IECEx Assembly by mounting with nut
- Pins / crimp terminal male / plug-in connector

**Characteristics**

- Housing material types: aluminum, brass chrome-plated or stainless steel
- High reliability, long lifetime with more than 20 mill. actuations
- Easy to clean due to a tightly closed surface (IP69K)
- for use in harsh environments (see technical data), in potentially explosive applications and environments where volatile fumes, gases and dust are present

**Other versions on request**

- Switch with short switching pulse, type: PSE NO
- Switch for longer switching signal duration, type: PSE IV
- Switch with enhanced vandal proof protection, type: PSE HI

**References**

Alternative: Other diameter [PSE EX 19](#); [PSE EX 22](#)

**Weblinks**

[pdf data sheet](#), [html datasheet](#), [General Product Information](#), [CAD-Drawings](#), [Product News](#), [Detailed request for product](#)

**Technical Data**

**Electrical Data**

Switching Function	momentary
Switching Voltage	Ui max. 24 / 24 VAC/DC
Switching Current	Ii max. 40 mA
Rated Breaking Capacity (Temperature Class T5/T100°C)	Pi max. 0.96 W
Rated Breaking Capacity (Temperature Class T6/T85°C)	Pi max. 0.7 W
Lifetime	20 million actuations at Rated Switching Capacity
Switch Resistance OFF	> 10 kΩ
Switch Resistance ON	< 20 mΩ
Capacity	5 pF
N.O. Closing Impulse Duration	20- 1000 ms
Contact Configuration	free polarity

**Mechanical Data**

Actuating Force	≤ 3 N at ambient temperature
Actuating Travel	0.002 mm
Shock Protection	IK02
Mounting screw torque	2.5 Nm

**Climatical Data**

Operating Temperature	-20 to 60 °C
Storage Temperature	-20 to 60 °C
IP-Protection	IP67 acc. to IEC 60529, IP69K acc. to DIN 40050-9

Environmental Assessment	+55°C / 93% r.h. acc. to DIN EN 60068-2-30
--------------------------	--

Salt Spray Test (acc. to DIN 50021-SS)	24 h / 48 h / 96 h Residence Time
--	-----------------------------------

**Material**

Housing (depending on type)	Stainless Steel, Aluminium anodized, Polyamide, Chromed Brass
-----------------------------	---

**Approvals and Compliances**



Detailed information on product approvals, code requirements, usage instructions and detailed test conditions can be looked up in [Details about Approvals](#)

SCHURTER products are designed for use in industrial environments. They have approvals from independent testing bodies according to national and international standards. Products with specific characteristics and requirements such as required in the automotive sector according to IATF 16949, medical technology according to ISO 13485 or in the aerospace industry can be offered exclusively with customer-specific, individual agreements by SCHURTER.

## Approvals





The approval mark is used by the testing authorities to certify compliance with the safety requirements placed on electronic products.

Approval Reference Type: PSE EX

Approval Logo	Certificates	Certification Body	Description
	<a href="#">Electrosuisse Approvals</a>	Electrosuisse	Certificate Number: SEV 13 ATEX 0170
	<a href="#">Electrosuisse Approvals</a>	Electrosuisse	Certificate Number: IECEx SEV 13.0011



## Application standards

Application standards where the product can be used

Organization	Design	Standard	Description
	Designed for applications acc.	EMC Directive:	Directive 2014/30/EU
	Designed for applications acc.	ATEX / IECEx Approval Marking:	Ex II 2 GD   Ex ib IIC T6...T5 Gb   Ex ib IIIC T85 °C ... T100 °C Db
	Designed for applications acc.	MIL-STD:	202F Method 107G, 202F Method 204D, 202F Method 213B, 416D Method RS103, 810E Method 501.3, 810E Method 502.3, 810E Method 507.3
	Designed for applications acc.	VDE Certificate Number:	DIN EN 61000-4-2, DIN EN 61000-4-4
	Designed for applications acc.	IEC/UL 62368-1	Audio/video, information and communication technology equipment - Part 1: Safety requirements

## Compliances

The product complies with following Guide Lines

Identification	Details	Initiator	Description
	<a href="#">RoHS</a>	SCHURTER AG	Directive RoHS 2011/65/EU, Amendment (EU) 2015/863
	<a href="#">REACH</a>	SCHURTER AG	On 1 June 2007, Regulation (EC) No 1907/2006 on the Registration, Evaluation, Authorization and Restriction of Chemicals 1 (abbreviated as "REACH") entered into force.

## Dimension [mm]

PSE 16 with Pins

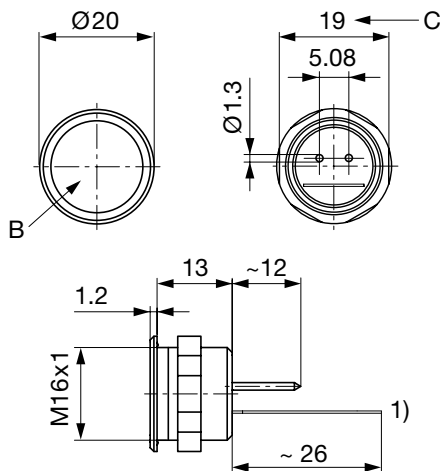

Legend:

1) = Type label

B = Actuating area

C = Width across flats

- Pins (with connection terminal 0701.9238)

Lettering:

- Either with/without lettering

- Position of the connections with respect to the position of the lettering is not defined

## Dimension

PSE 16

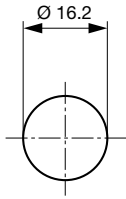

Drilling diagram

## Marking

The last three digits in the order number define the lettering:

001-076	Standard Lettering
101-	Customized Lettering

### Lettering - Aluminium / Plastic Material

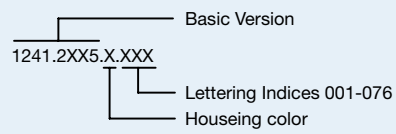

### Lettering - Stainless Steel

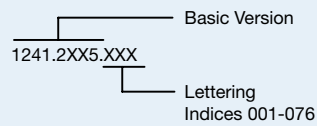

## Lettering Colour of Laser Lettering

Material	Lettering Colour	
Stainless Steel	black	Filled letters
Aluminum natural anodized	light grey	Filled letters (only after customer approval)
Aluminum coloured anodized	light grey	Filled letters

## Order Index Lettering

Laser Marking			
001 =A	021 =U	041 =‡	061 =EIN
002 =B	022 =V	042 = *	062 =AUS
003 =C	023 =W	043 ==	063 =AUF
004 =D	024 =X	044 = #	064 =AB
005 =E	025 =Y	045 = ↔	065 =ON
006 =F	026 =Z	046 = †	066 =OFF
007 =G	027 =0	047 = →	067 =UP
008 =H	028 =1	048 = ←	068 =DOWN
009 =I	029 =2	049 = ↓	069 =HIGH
010 =J	030 =3	050 = ↑	070 =LOW
011 =K	031 =4	051 = %	071 =ON/OFF
012 =L	032 =5	052 = √	072 =START
013 =M	033 =6	053 =CTRL	073 =RESET
014 =N	034 =7	054 =RETURN	074 =⏻
015 =O	035 =8	055 =SHIFT	075 =💡
016 =P	036 =9	056 =LOCK	076 =🔔
017 =Q	037 =+	057 =STOP	077 =⓪
018 =R	038 =-	058 =ENTER	
019 =S	039 =.	059 =BACK	
020 =T	040 =x	060 =LINE	

Please note that the font size depends on the number of characters

## All Variants

Mounting Diameter [mm]	Terminal	Housing Material	Colour of Housing	Config. Code	Order Number
16	Pins	Aluminum	gold	PSE 16 EX	1241.2415.1
16	Pins	Aluminum	red	PSE 16 EX	1241.2415.3
16	Pins	Aluminum	green	PSE 16 EX	1241.2415.5
16	Pins	Aluminum	Alu natural	PSE 16 EX	1241.2415.8

Annotation to the protection type:

- The explosion protected piezo switch element (PSE EX) has the function of a NO (normally open) switch.
- Permissible voltage and current of the PSE EX are limited, so that the PSE EX is intrinsically safe in accordance with EN60079-11 (see Technical Data).
- The use of the PSE EX is permitted in areas where the formation of explosive atmospheres caused by gases, fumes, mist or dust mixing with air occurs occasionally. The explosion protected PSE is classified according to EN 60079-0 in the device group II, category 2.

Attention:

- The permissible operating temperature is - 20°C to 60°C.
- The approval will cease when the type label is removed.
- The switch has to be installed and used according to IEC/EN 60079-14 and IEC/EN 60079-25.

The listed item numbers represent a selection of the range of piezo switches. Other mounting diameters, materials, colors, connections and symbols are available on request. Special materials for use in salt and chlorinated environment on request.

The MOQ for standard laser lettering on standard variants is a packing unit.

Availability for all products can be searched real-time: <https://www.schurter.com/en/Stock-Check/Stock-Check-SCHURTER>

**Packaging unit**

10 in cardboard box packed in air cushion bag with instruction manual



- Actuating elements in ESD safe packaging
- Screw nuts and sealing O-ring in a bag (enclosed in the box)

**Accessories**

**Description**



Connecting Terminal PSE  
Connecting Terminal