

DATA SHEET

NE/SA5521 LVDT signal conditioner

Product data
Supersedes data of 2002 Nov 05

2003 Dec 03

LVDT signal conditioner

NE/SA5521

DESCRIPTION

The NE/SA5521 is a signal conditioning circuit for use with Linear Variable Differential Transformers (LVDTs) and Rotary Variable Differential Transformers (RVDTs). The chip includes a low distortion, amplitude-stable sine wave oscillator with programmable frequency to drive the primary of the LVDT/RVDT, a synchronous demodulator to convert the LVDT/RVDT output amplitude and phase to position information, and an output amplifier to provide amplification and filtering of the demodulated signal.

FEATURES

- Low distortion
- Single supply 5 V to 20 V, or dual supply ± 2.5 V to ± 10 V
- Oscillator frequency 1 kHz to 20 kHz
- Capable of ratiometric operation
- Low power consumption (182 mV typ)

APPLICATIONS

- LVDT signal conditioning

- RVDT signal conditioning
- LPDT signal conditioning
- Bridge circuits

PIN CONFIGURATIONS

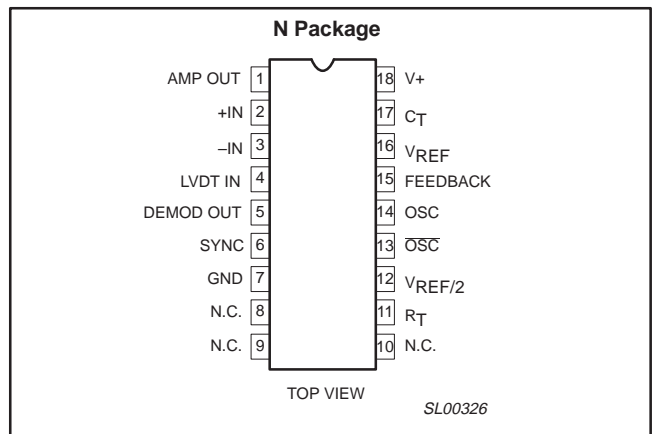

Figure 1. Pin configurations

ORDERING INFORMATION

ORDER CODE	DESCRIPTION	TEMPERATURE RANGE	DWG #
NE5521N	18-Pin Plastic Dual In-Line Package (DIP)	0 °C to +70 °C	SOT102-4
SA5521N	18-Pin Plastic Dual In-Line Package (DIP)	-40 °C to +85 °C	SOT102-4

ABSOLUTE MAXIMUM RATINGS

SYMBOL	PARAMETER	RATING	UNIT
V_{CC}	Supply voltage	+20	V
	Split supply voltage	± 10	V
T_{amb}	Operating temperature range	0 to 70	°C
	NE5521	-40 to +85	°C
	SA5521		
T_{stg}	Storage temperature range	-65 to +125	°C
P_D	Power dissipation ¹	910	mW

NOTES:

1. For derating, see typical power dissipation versus load curves (Figure 3).

LVDT signal conditioner

NE/SA5521

BLOCK DIAGRAM

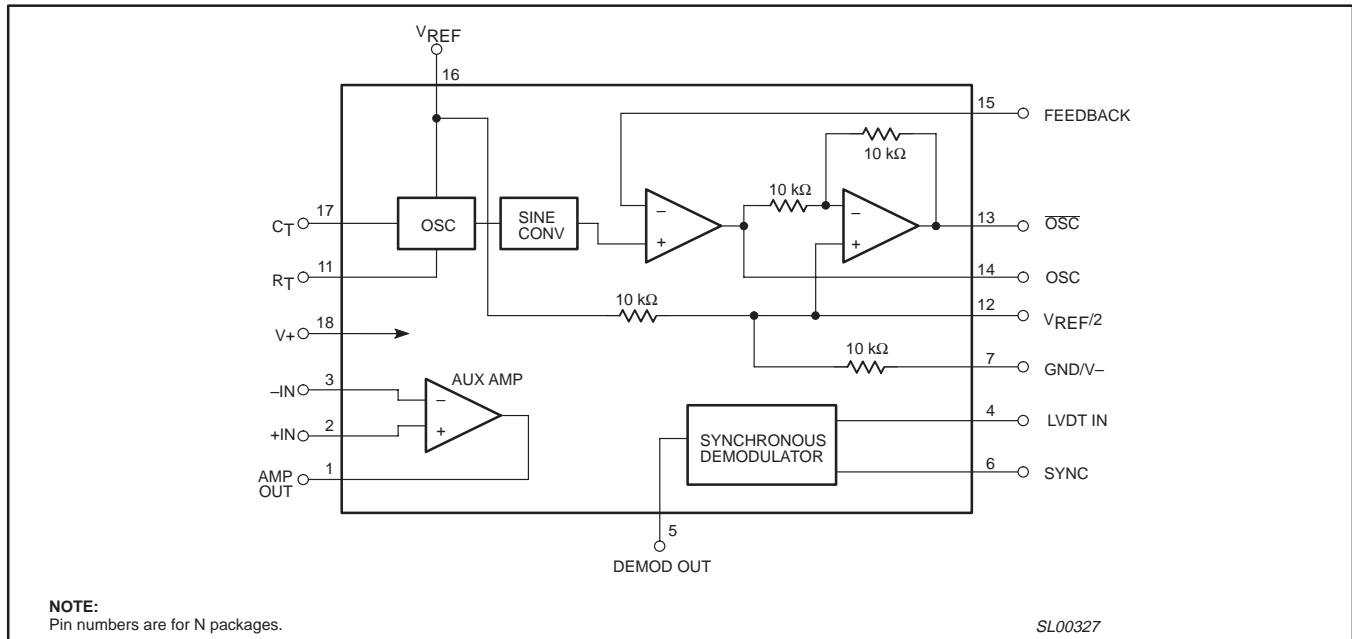

Figure 2. Block diagram.

PIN DEFINITIONS

PIN NO.	SYMBOL	DEFINITION
1	Amp Out	Auxiliary Amplifier Out.
2	+IN	Auxiliary Amplifier non-inverting input.
3	-IN	Auxiliary Amplifier inverting input.
4	LVDT IN	Input to Synchronous Demodulator from the LVDT/RVDT secondary.
5	DEMOD OUT	Pulsating DC output from the Synchronous Demodulator output. This voltage should be filtered before use.
6	SYNC	Synchronizing input for the Synchronizing Demodulator. This input should be connected to the OSC or $\overline{\text{OSC}}$ output. Sync is referenced to $V_{\text{REF}}/2$.
7	GND	Device return. Should be connected to system ground or to the negative supply.
8	NC	No internal connection.
9	NC	No internal connection.
10	NC	No internal connection.
11	R_T	A temperature stable 18 kΩ resistor should be connected between this pin and Pin 7.
12	$V_{\text{REF}}/2$	A high impedance source of one half the potential applied to V_{REF} . The LVDT/RVDT secondary return should be to this point. A bypass capacitor with low impedance at the oscillator frequency should also be connected between this pin and ground.
13	$\overline{\text{OSC}}$	Oscillator sine wave output that is 180° out of phase with the OSC signal. The LVDT/RVDT primary is usually connected between OSC and $\overline{\text{OSC}}$ pins.
14	OSC	Oscillator sine wave output. The LVDT/RVDT primaries are usually connected between OSC and $\overline{\text{OSC}}$ pins.
15	FEEDBACK	Usually connected to the OSC output for unity gain, a resistor between this pin and OSC, and one between this pin and ground can provide for a change in the oscillator output pin amplitudes.
16	V_{REF}	Reference voltage input for the oscillator and sine converter. This voltage MUST be stable and must not exceed +V supply voltage.
17	C_T	Oscillator frequency-determining capacitor. The capacitor connected between this pin and ground should be a temperature-stable type.
18	+V	Positive supply connection.

LVDT signal conditioner

NE/SA5521

DC ELECTRICAL CHARACTERISTICS

$V_+ = V_{REF} = 10\text{ V}$; $T_{amb} = 0\text{ }^\circ\text{C}$ to $70\text{ }^\circ\text{C}$ for NE5521, $T_{amb} = -40\text{ }^\circ\text{C}$ to $85\text{ }^\circ\text{C}$ for SA5521; Frequency = 1 kHz, unless otherwise noted.

SYMBOL	PARAMETER	TEST CONDITIONS	NE5521			SA5521			UNIT
			Min	Typ	Max	Min	Typ	Max	
V_{CC}	Supply current			12.9	20		12.9	18	mA
I_{REF}	Reference current			5.3	8		5.3	8	mA
V_{REF}	Reference voltage range		5		V_+	5		V_+	V
P_D	Power dissipation			182	280		182	260	mW
Oscillator Section									
	Oscillator output	$R_L = 10\text{ k}\Omega$	$\frac{V_{REF}}{8.8}$				$\frac{V_{REF}}{8.8}$		V_{RMS}
THD	Sine wave distortion	No load		1.5			1.5		%
	Initial amplitude error	$T_{amb} = 25\text{ }^\circ\text{C}$		0.4	± 3		0.4	± 3	%
	Tempco of amplitude			0.005	0.01		0.005	0.01	%/ $^\circ\text{C}$
	Init. accuracy of oscillator freq.	$T_{amb} = 25\text{ }^\circ\text{C}$		± 0.9	± 5		± 0.9	± 5	%
	Temperature coeff. of frequency ¹			0.05			0.05		%/ $^\circ\text{C}$
	Voltage coeff. of frequency			2.5			3.3		%/ $V(V_{REF})$
	Min OSC (OSC) Load ²		300	170		300	170		Ω
Demodulator Section									
ϵ_r	Linearity error	$5 V_{P-P}$ input		± 0.05	± 0.1		± 0.05	± 0.1	%FS
	Maximum demodulator input			$\frac{V_{REF}}{2}$			$\frac{V_{REF}}{2}$		V_{P-P}
V_{OS}	Demodulator offset voltage			± 1.4	± 5		± 1.4	± 5	mV
TCV_{OS}	Demodulator offset voltage drift			5	25		5	25	$\mu\text{V}/^\circ\text{C}$
I_{BIAS}	Demodulator input current		-600	-234		-500	-234		nA
	$V_{R/2}$ accuracy			± 0.1	± 1		± 0.1	± 1	%
Auxiliary Output Amplifier									
V_{OS}	Input offset voltage			± 0.5	± 5		± 0.5	± 5	mV
I_{BIAS}	Input bias current		-600	-210		-500	-210		nA
I_{OS}	Input offset current			10	50		10	50	nA
A_V	Gain		100	385		100	385		V/mV
SR	Slew rate			1.3			1.3		V/ μs
GBW	Unity gain bandwidth product	$A_V = 1$		1.6			1.6		MHz
	Output voltage swing	$R_L = 10\text{ k}\Omega$	7	8.2		7	8.2		V
	Output short circuit current to ground or to V_{CC}	$T_{amb} = 25\text{ }^\circ\text{C}$		42	100		42	100	mA

NOTES:

1. This is temperature coefficient of frequency for the device only. It is assumed that C_T and R_T are fixed in value and C_T leakage is fixed over the operating temperature range.
2. Minimum load impedance for which distortion is guaranteed to be less than 5%.

LVDT signal conditioner

NE/SA5521

DEFINITION OF TERMS

TERM	DEFINITION
Oscillator output	RMS value of the AC voltage at the oscillator output pin. This output is referenced to $V_{REF}/2$ and is a function of V_{REF} .
Sine wave distortion	The Total Harmonic Distortion (THD) of the oscillator output with no load. This is not a critical specification in LVDT/RVDT systems. This figure could be 15% or more without affecting system performance.
Initial amplitude error	A measure of the interchangeability of NE/SA5521 parts, not a characteristic of any one part. It is the degree to which the oscillator output of a number of NE/SA5521 samples will vary from the median of that sample.
Initial accuracy of oscillator frequency	Another measure of the interchangeability of individual NE/SA5521 parts. This is the degree to which the oscillator frequency of a number of NE/SA5521 samples will vary from the median of that sample with a given timing capacitor.
Tempco of oscillator amplitude	A measure of how the oscillator amplitude varies with ambient temperature as that temperature deviates from a 25 °C ambient.
Tempco of oscillator frequency	A measure of how the oscillator frequency varies with ambient temperature as that temperature deviates from a 25 °C ambient.
Voltage coefficient of oscillator frequency	The degree to which the oscillator frequency will vary as the reference voltage (V_{REF}) deviates from +10 V.
Min OSC (\overline{OSC}) load	Minimum load impedance for which distortion is guaranteed to be less than 5%.
Linearity error	The degree to which the DC output of the demodulator/amplifier combination matches a change in the AC signal at the demodulator input. It is measured as the worst case nonlinearity from a straight line drawn between positive and negative fullscale end points.
Maximum demodulator input	The maximum signal that can be applied to the demodulator input without exceeding the specified linearity error.

APPLICATION INFORMATION

$$OSC \text{ frequency} = \frac{V_{REF} - 1.3V}{V_{REF} (R_T + 1.5k) C_T}$$

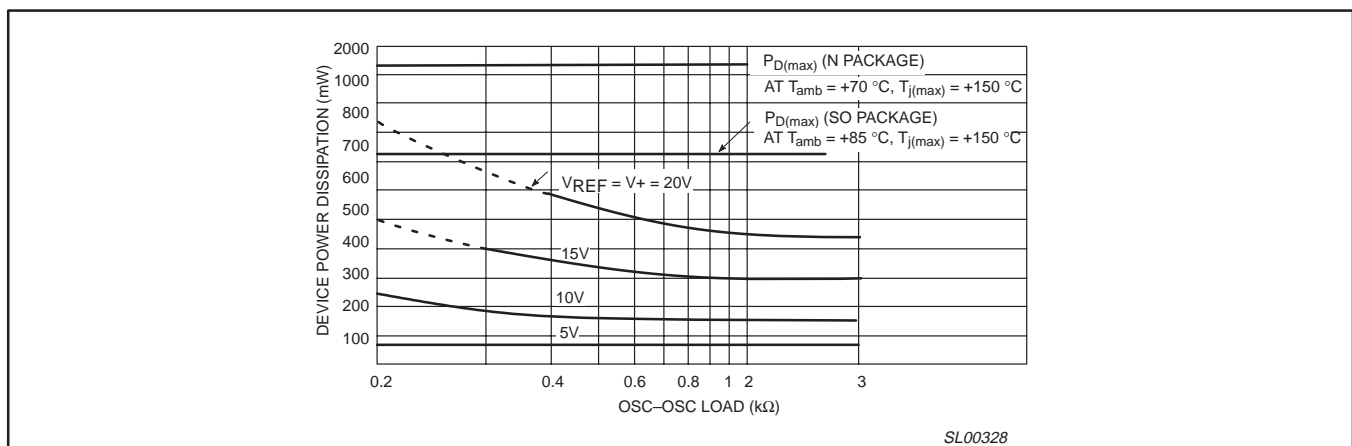

Figure 3. Device power dissipation versus OSC – \overline{OSC} Load at +25 °C

LVDT signal conditioner

NE/SA5521

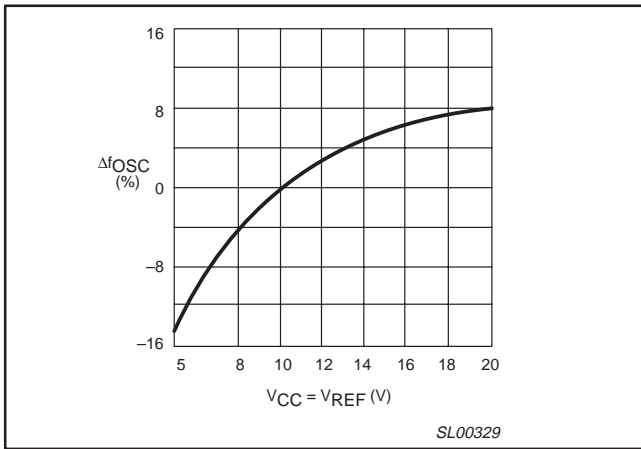

Figure 4. Oscillator frequency variation with voltage (Normalized to $V_{REF} = V_{CC} = 10$ V) $T_{amb} = +25$ °C

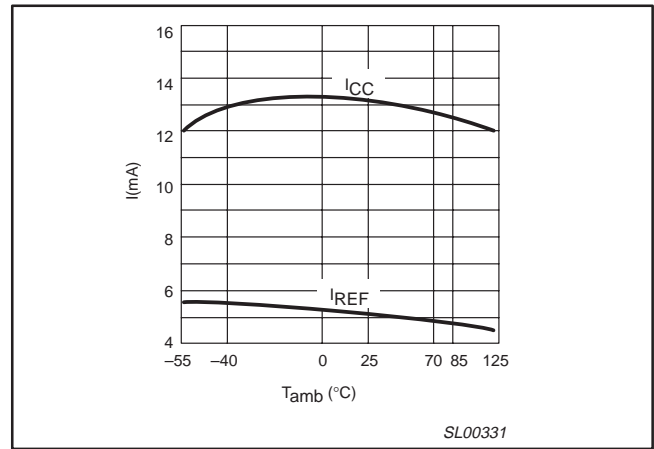

Figure 6. I_{REF} and I_{CC} versus Temperature ($V_{REF} = V_{CC} = 10$ V)

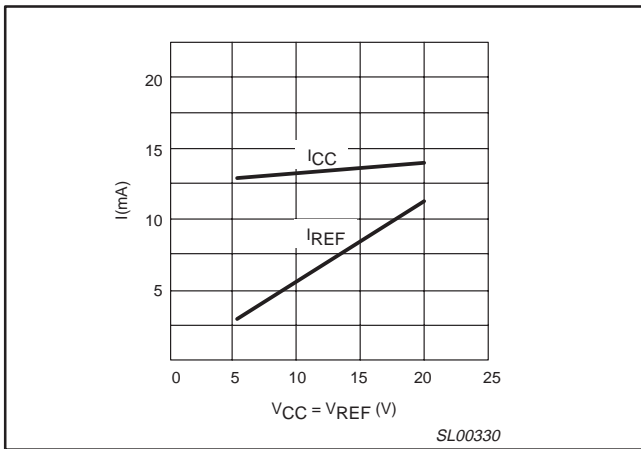

Figure 5. I_{REF} and I_{CC} versus voltage ($T_{amb} = +25$ °C)

LVDT signal conditioner

NE/SA5521

DIP18: plastic dual in-line package; 18 leads (300 mil); long body

SOT102-4

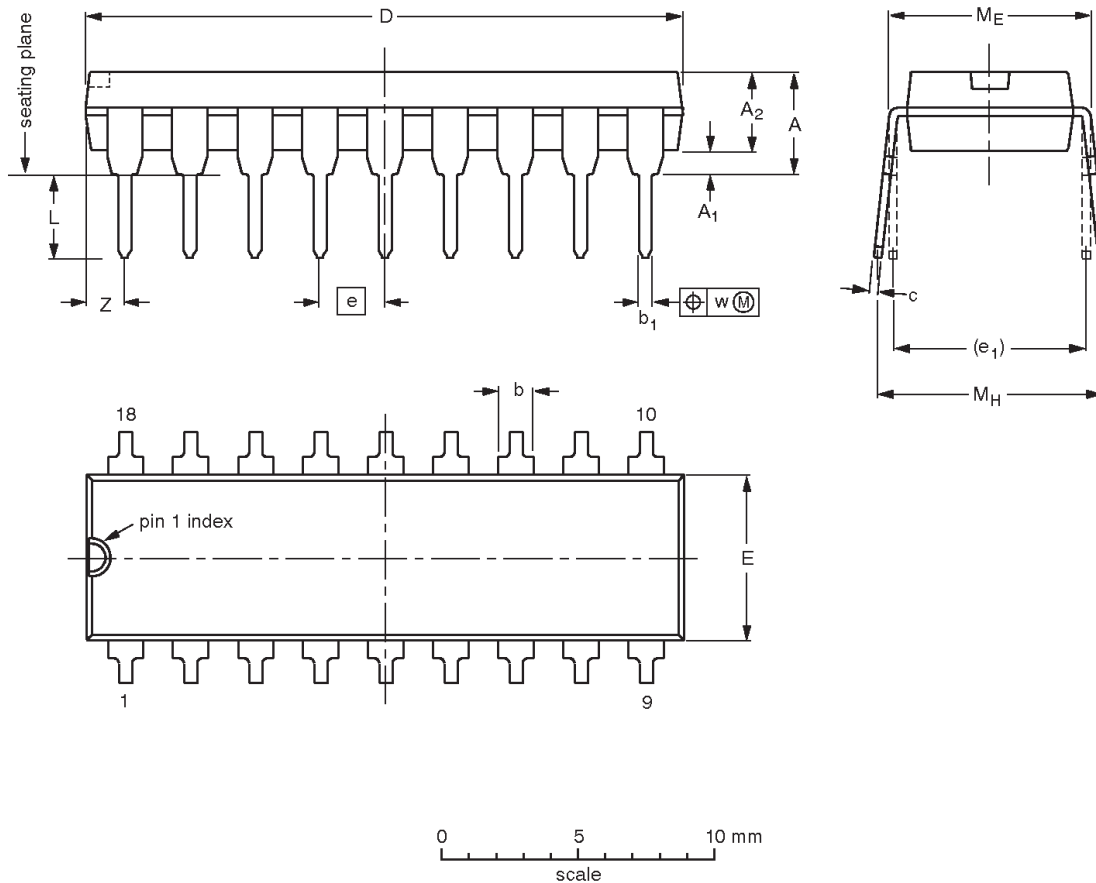

DIMENSIONS (mm dimensions are derived from the original inch dimensions)

UNIT	A max.	A ₁ min.	A ₂ max.	b	b ₁	c	D ⁽¹⁾	E ⁽¹⁾	e	e ₁	L	M _E	M _H	w	Z ⁽¹⁾ max.
mm	4.06	0.51	3.38	1.63 1.14	0.56 0.43	0.36 0.25	23.37 22.61	6.48 6.22	2.54	7.62	3.51 3.05	8.13 7.62	10.03 7.62	0.25	1.65
inches	0.16	0.02	0.14	0.064 0.045	0.022 0.017	0.014 0.010	0.92 0.89	0.255 0.245	0.1	0.3	0.138 0.120	0.32 0.30	0.395 0.300	0.01	0.065

Note

1. Plastic or metal protrusions of 0.25 mm (0.01 inch) maximum per side are not included.

OUTLINE VERSION	REFERENCES				EUROPEAN PROJECTION	ISSUE DATE
	IEC	JEDEC	JEITA			
SOT102-4		MS-001				99-12-27 03-03-12

LVDT signal conditioner

NE/SA5521

REVISION HISTORY

Rev	Date	Description
_3	20031203	Product data; third version (9397 750 12463); ECN 853-0043 01-A14810 Modifications: <ul style="list-style-type: none">• Delete all references to D package.
_2	20021105	Product data; second version (9397 750 10666). Supersedes NE/SA/SE5521 of 1994 Aug 31.
_1	19940831	Product data; initial version. Engineering Change Notice 853-0043 13721 (date: 19940831).

LVDT signal conditioner

NE/SA5521

Data sheet status

Level	Data sheet status ^[1]	Product status ^{[2] [3]}	Definitions
I	Objective data	Development	This data sheet contains data from the objective specification for product development. Philips Semiconductors reserves the right to change the specification in any manner without notice.
II	Preliminary data	Qualification	This data sheet contains data from the preliminary specification. Supplementary data will be published at a later date. Philips Semiconductors reserves the right to change the specification without notice, in order to improve the design and supply the best possible product.
III	Product data	Production	This data sheet contains data from the product specification. Philips Semiconductors reserves the right to make changes at any time in order to improve the design, manufacturing and supply. Relevant changes will be communicated via a Customer Product/Process Change Notification (CPCN).

[1] Please consult the most recently issued data sheet before initiating or completing a design.

[2] The product status of the device(s) described in this data sheet may have changed since this data sheet was published. The latest information is available on the Internet at URL <http://www.semiconductors.philips.com>.

[3] For data sheets describing multiple type numbers, the highest-level product status determines the data sheet status.

Definitions

Short-form specification — The data in a short-form specification is extracted from a full data sheet with the same type number and title. For detailed information see the relevant data sheet or data handbook.

Limiting values definition — Limiting values given are in accordance with the Absolute Maximum Rating System (IEC 60134). Stress above one or more of the limiting values may cause permanent damage to the device. These are stress ratings only and operation of the device at these or at any other conditions above those given in the Characteristics sections of the specification is not implied. Exposure to limiting values for extended periods may affect device reliability.

Application information — Applications that are described herein for any of these products are for illustrative purposes only. Philips Semiconductors make no representation or warranty that such applications will be suitable for the specified use without further testing or modification.

Disclaimers

Life support — These products are not designed for use in life support appliances, devices, or systems where malfunction of these products can reasonably be expected to result in personal injury. Philips Semiconductors customers using or selling these products for use in such applications do so at their own risk and agree to fully indemnify Philips Semiconductors for any damages resulting from such application.

Right to make changes — Philips Semiconductors reserves the right to make changes in the products—including circuits, standard cells, and/or software—described or contained herein in order to improve design and/or performance. When the product is in full production (status 'Production'), relevant changes will be communicated via a Customer Product/Process Change Notification (CPCN). Philips Semiconductors assumes no responsibility or liability for the use of any of these products, conveys no license or title under any patent, copyright, or mask work right to these products, and makes no representations or warranties that these products are free from patent, copyright, or mask work right infringement, unless otherwise specified.

Contact information

For additional information please visit
<http://www.semiconductors.philips.com>. Fax: +31 40 27 24825

© Koninklijke Philips Electronics N.V. 2003
 All rights reserved. Printed in U.S.A.

Date of release: 12-03

For sales offices addresses send e-mail to:
sales.addresses@www.semiconductors.philips.com

Document order number:

9397 750 12463

Let's make things better.