

3117

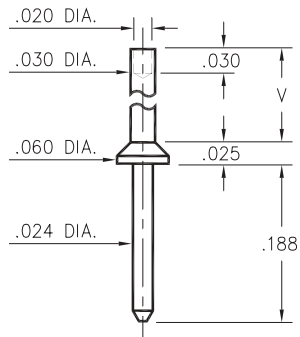

Basic Part Number	Board Thickness	Length V
3117-1	.031	.047
3117-2	.062	.078
3117-3	.094	.110
3117-4	.125	.141

3117-X-00-XX-00-00-08-0
Swage mount in .035 hole

3114/3115

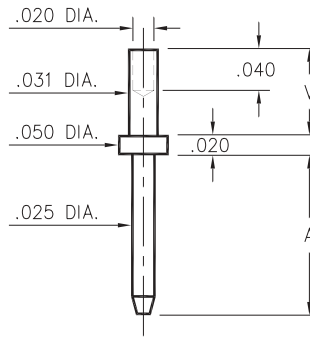

Basic Part Number	Board Thickness	Length A	Length V
3114-1	.031	.150	.051
3114-2	.062	.150	.082
3115-1	.031	.300	.051
3115-2	.062	.300	.082

311X-X-00-XX-00-00-08-0
Swage mount in .035 mounting hole

3112

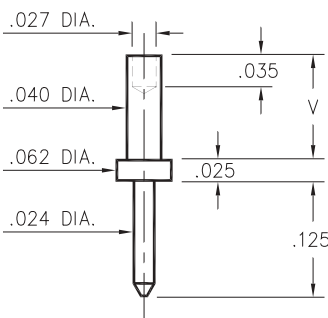

Basic Part Number	Board Thickness	Length V
3112-1	.031	.051
3112-2	.062	.082
3112-3	.094	.113

3112-X-00-XX-00-00-08-0
Swage mount in .043 hole

3118/3119

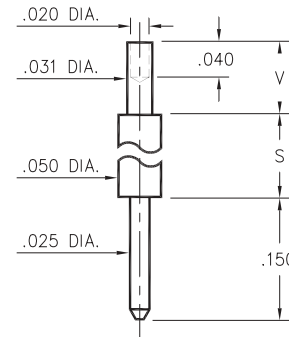

Basic Part Number	Board Thickness	Length S	Length V
3118-1	.031	.170	.051
3118-2	.062	.170	.082
3119-1	.031	.420	.051
3119-2	.062	.420	.082

311X-X-00-XX-00-00-08-0
Swage mount in .035 hole

3139

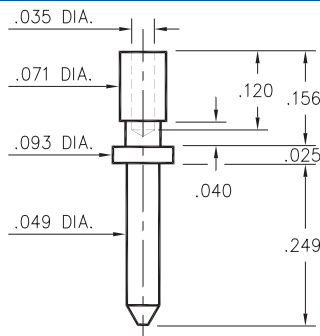

3139-0-00-XX-00-00-08-0
Wire Termination

3602

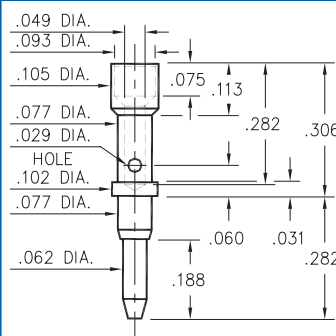

3602-0-07-XX-00-00-08-0
Annealed #20 Crimp barrel

3131

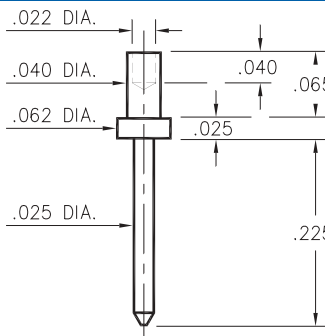

3131-1-00-XX-00-00-08-0
Swage mount in .043 hole

0912

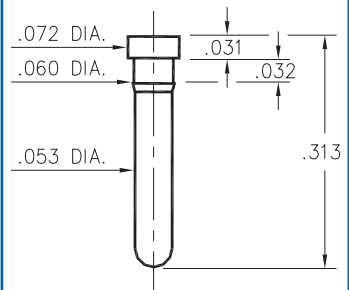

0912-0-00-XX-00-00-03-0
Press-fit in .057 mounting hole

SPECIFICATIONS

PIN MATERIAL:
Brass Alloy 360, 1/2 Hard
(Except Swage pins which are annealed)

DIMENSION IN INCHES
TOLERANCES ON:
LENGTHS: ±.005
DIAMETERS: ±.002
ANGLES: ± 2°

ORDER CODE: XXXX - X - 0X - XX - 00 - 00 - 0X - 0

BASIC PART # →

SPECIFY PIN FINISH:
01 200μ" TIN/LEAD OVER NICKEL
15 10μ" GOLD OVER NICKEL
21 20μ" GOLD OVER NICKEL
34 50μ" GOLD OVER NICKEL