

# WLS27CW430DSQ

## Work Light – Linear Light

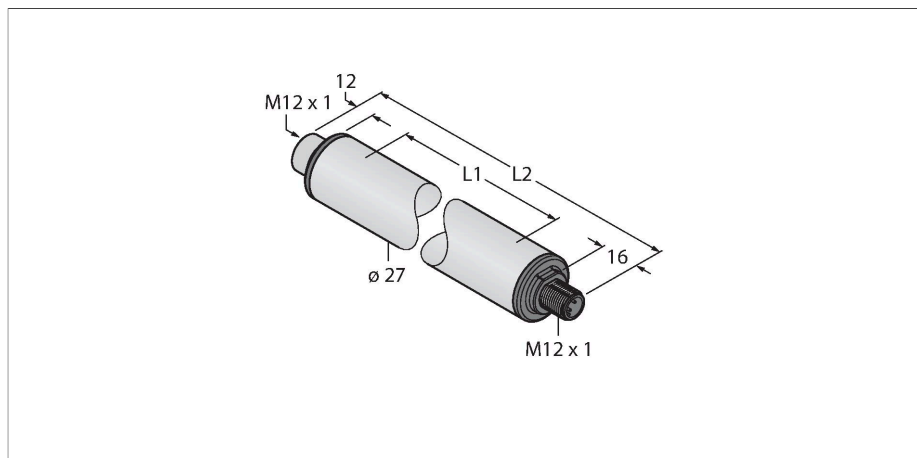

### Features

- Cylindrical illuminated area
- Cascadable
- Operating voltage: 12...30 VDC
- Protection class IP67/IP69K
- M12 x 1 male, straight, 4-pin
- Light length L1: 430 mm
- Housing length L2: 499 mm
- Color: White
- Cascadable
- Automatic temperature monitoring
- FDA compliant
- 2 x LMBWLS27EC snap bracket included in delivery

### Wiring diagram

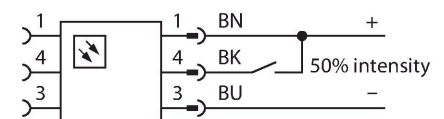

### Functional principle

LED-Arbeitsleuchten eignen sich hervorragend für den industriellen Einsatz bei geringem Energieverbrauch. Die Farbtemperatur liegt im Bereich 6.000 bis 7.100 Kelvin (kaltweiß). Der Lichtstrom beträgt je nach Modell 325 und 2600 Lumen. Das Ein-/ Ausschalten erfolgt über die Zuschaltung der nötigen Versorgungsspannung (12...30 VDC). Darüberhinaus lässt sich diese durch Ansteuerung eines High-Signals auf PIN4 auf 50% ihrer Lichtleistung dimmen, bei zweifarbigen Varianten wird zwischen den Farben gewechselt. Ein Stufenloses Dimmen der Lichtleistung ist bei einigen Modellen über ein PWM-Signal auf PIN4 möglich. Kaskadierbare Versionen sind ebenfalls

### Technical data

Type	WLS27CW430DSQ
ID	3094300
<b>Signal and display data</b>	
Purpose	LED work light
Function	Linear light
Light type	White
Color temperature	6100...+7000 K
Luminous flux lumen	975 lm
LED service life (L70)	50000 h
Dimmable	Two-stage
Features of color 1	White, Permanently on, 1200 lm
Special features	Chemical-resistant Wash down Resistant to chemicals
<b>Electrical data</b>	
Operating voltage	12...30 VDC
Max. current consumption per color	1200 mA
Input power	11.04 W
<b>Mechanical data</b>	
Cascadable	Yes
Design	Smooth barrel, WLS27
Dimensions	Ø 27 x 499 x 501 x 501 mm
Housing material	Plastic, FDA copolyester
Window material	Copolyester, diffuse
Electrical connection	Connector, M12 x 1, PVC
Number of cores	4
Ambient temperature	-40...+70 °C

## Technical data



Storage temperature	-40...+70 °C
Protection class	IP66 IP67 IP69
Protection class for electrical equipment	III
Tests/approvals	

erhältlich. Verfügbare Farben sind kaltweiss, warmweiss, grün, rot, gelb und blau.  
 Applikationshinweis:  
 Kaskadierung bei 12 V Versorgung erlaubt Gesamtlänge von 1,4 m. Kaskadierung bei 24 V Versorgung erlaubt Gesamtlänge von 3,0 m. Kaskadierung bei 30 V Versorgung erlaubt Gesamtlänge von 3,1 m.  
 Bei 50% Lichtintensität sind die Längenangaben zu verdoppeln.

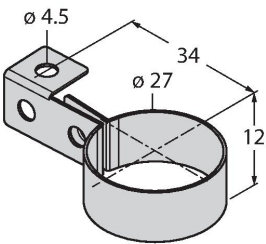
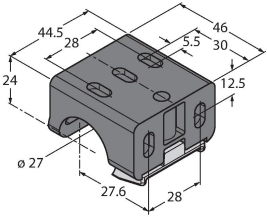
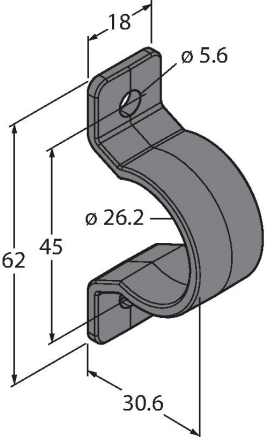
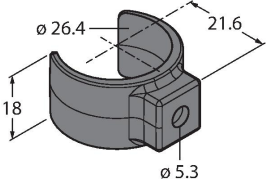
## Accessories

<b>LMBWLS27H</b>  Hanging bracket for WLS27	3094776	<b>LMBWLS27U</b>  Universal mounting bracket for WLS27	3094775
<b>LMBWLS27EC</b>  Snap bracket for WLS27	3094774	<b>LMBWLS27SP</b>  Snap bracket for WLS27	3094773

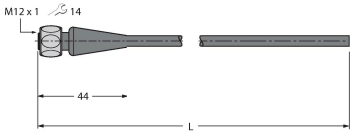
## Accessories

Dimension drawing	Type	ID	
	RKH4.5-2/TFG	6933455	Connection cable, M12 female, straight, 5-pin, stainless steel coupling nut, cable length: 2 m, jacket material: TPE, gray, temperature range -40...+105 °C; other cable lengths and designs available, see <a href="http://www.turck.com">www.turck.com</a>
	RKC4.4T-2/TEL	6625013	Connection cable, female M12, straight, 4-pin, cable length: 2 m, sheath material: PVC, black; cULus approval; other cable lengths and qualities available, see <a href="http://www.turck.com">www.turck.com</a>

## Dimension drawing

## Type

WKC4.4T-2/TEL

## ID

6625025

Connection cable, female M12, angled,  
4-pin, cable length: 2 m, sheath  
material: PVC, black; cULus approval;  
other cable lengths and qualities  
available, see [www.turck.com](http://www.turck.com)

