

National Semiconductor is now part of
Texas Instruments.

Search <http://www.ti.com/> for the latest technical
information and details on our current products and services.

CD4070BM/CD4070BC Quad 2-Input EXCLUSIVE-OR Gate CD4077BM/CD4077BC Quad 2-Input EXCLUSIVE-NOR Gate

General Description

Employing complementary MOS (CMOS) transistors to achieve wide power supply operating range, low power consumption, and high noise margin, the CD4070BM/BC and CD4077BM/BC provide basic functions used in the implementation of digital integrated circuit systems. The N- and P-channel enhancement mode transistors provide a symmetrical circuit with output swing essentially equal to the supply voltage. No DC power other than that caused by leakage current is consumed during static condition. All inputs are protected from damage due to static discharge by diode clamps to V_{DD} and V_{SS} .

Features

- Wide supply voltage range 3.0V to 15V
- High noise immunity 0.45 V_{DD} typ.
- Low power TTL compatibility Fan out of 2 driving 74L or 1 driving 74LS
- CD4070B—Pin compatible to CD4030A
 - Equivalent to MM54C86/MM74C86 and MC14070B
- CD4077B—Equivalent to MC14077B

Connection Diagram

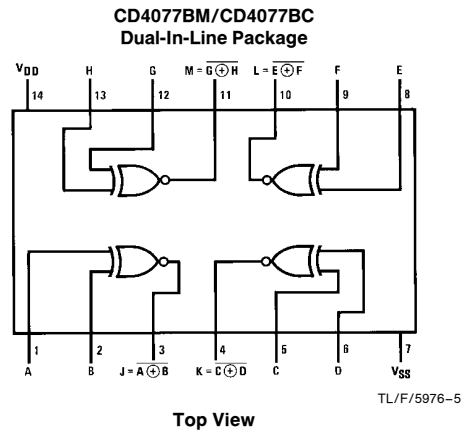
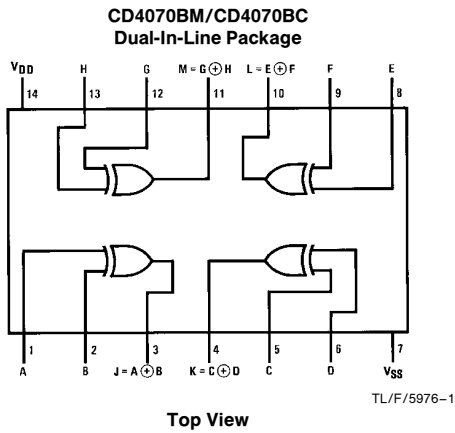

Typical Performance Characteristics

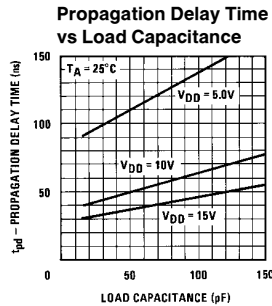

Truth Tables

CD4070BM/CD4070BC			CD4077BM/CD4077BC		
Inputs		Outputs	Inputs		Outputs
A	B	Y	A	B	Y
L	L	L	L	L	H
L	H	H	L	H	L
H	L	H	H	L	L
H	H	L	H	H	H

Absolute Maximum Ratings (Notes 1 and 2)

If Military/Aerospace specified devices are required, please contact the National Semiconductor Sales Office/Distributors for availability and specifications.

DC Supply Voltage (V_{DD})	-0.5 to +18 V_{DC}
Input Voltage (V_{IN})	-0.5 to V_{DD} + 0.5 V_{DC}
Storage Temperature Range (T_S)	-65°C to +150°C
Power Dissipation (P_D)	
Dual-In-Line	700 mW
Small Outline	500 mW
Lead Temperature (T_L)	
(Soldering, 10 seconds)	260°C

Recommended Operating Conditions (Note 2)

DC Supply Voltage (V_{DD})	3V to 15 V_{DC}
Input Voltage (V_{IN})	0 to V_{DD} V_{DC}
Operating Temperature Range (T_A)	
CD4070BC/CD4077BC	-40°C to +85°C
CD4070BM/CD4077BM	-55°C to +125°C

DC Electrical Characteristics CD4070BM/CD4077BM (Note 2)

Symbol	Parameter	Conditions	-55°C		+25°C			+125°C		Units
			Min	Max	Min	Typ	Max	Min	Max	
I_{DD}	Quiescent Device Current	$V_{DD} = 5V$, $V_{IN} = V_{DD}$ or V_{SS}		0.25			0.25		7.5	μA
		$V_{DD} = 10V$, $V_{IN} = V_{DD}$ or V_{SS}		0.5		0.5		15	μA	
		$V_{DD} = 15V$, $V_{IN} = V_{DD}$ or V_{SS}		1.0		1.0		30	μA	
V_{OL}	Low Level Output Voltage	$ I_O < 1 \mu A$ $V_{DD} = 5V$		0.05		0	0.05		0.05	V
		$V_{DD} = 10V$		0.05		0	0.05		0.05	V
		$V_{DD} = 15V$		0.05		0	0.05		0.05	V
V_{OH}	High Level Output Voltage	$ I_O < 1 \mu A$ $V_{DD} = 5V$	4.95		4.95	5		4.95		V
		$V_{DD} = 10V$	9.95		9.95	10		9.95		V
		$V_{DD} = 15V$	14.95		14.95	15		14.95		V
V_{IL}	Low Level Input Voltage	$ I_O < 1 \mu A$ $V_{DD} = 5V$, $V_O = 4.5V$ or $0.5V$		1.5			1.5		1.5	V
		$V_{DD} = 10V$, $V_O = 9V$ or $1.0V$		3.0			3.0		3.0	V
		$V_{DD} = 15V$, $V_O = 13.5V$ or $1.5V$		4.0			4.0		4.0	V
V_{IH}	High Level Input Voltage	$ I_O < 1 \mu A$ $V_{DD} = 5V$, $V_O = 0.5V$ or $4.5V$	3.5		3.5			3.5		V
		$V_{DD} = 10V$, $V_O = 1.0V$ or $9.0V$	7.0		7.0			7.0		V
		$V_{DD} = 15V$, $V_O = 1.5V$ or $13.5V$	11.0		11.0			11.0		V
I_{OL}	Low Level Output Current (Note 3)	$V_{DD} = 5V$, $V_O = 0.4V$	0.64		0.51	0.88		0.36		mA
		$V_{DD} = 10V$, $V_O = 0.5V$	1.6		1.3	2.25		0.9		mA
		$V_{DD} = 15V$, $V_O = 1.5V$	4.2		3.4	8.8		2.4		mA
I_{OH}	High Level Output Current (Note 3)	$V_{DD} = 5V$, $V_O = 4.6V$	-0.64		-0.51	-0.88		-0.36		mA
		$V_{DD} = 10V$, $V_O = 9.5V$	-1.6		-1.3	-2.25		-0.9		mA
		$V_{DD} = 15V$, $V_O = 13.5V$	-4.2		-3.4	-8.8		-2.4		mA
I_{IN}	Input Current	$V_{DD} = 15V$, $V_{IN} = 0V$		-0.1		-10^{-5}	-0.1		-1.0	μA
		$V_{DD} = 15V$, $V_{IN} = 15V$		0.1		10^{-5}	0.1		1.0	μA

Note 1: "Absolute Maximum Ratings" are those values beyond which the safety of the device cannot be guaranteed. They are not meant to imply that the devices should be operated at these limits. The table of "Recommended Operating Conditions" and "Electrical Characteristics" provides conditions for actual device operation.

Note 2: $V_{SS} = 0V$ unless otherwise specified.

Note 3: I_{OL} and I_{OH} are tested one output at a time.

DC Electrical Characteristics CD4070BC/CD4077BC (Note 2)

Symbol	Parameter	Conditions	-40°C		+25°C			+85°C		Units
			Min	Max	Min	Typ	Max	Min	Max	
I _{DD}	Quiescent Device Current	V _{DD} = 5V, V _{IN} = V _{DD} or V _{SS}		1.0			1.0		7.5	μA
		V _{DD} = 10V, V _{IN} = V _{DD} or V _{SS}		2.0		2.0		15	μA	
		V _{DD} = 15V, V _{IN} = V _{DD} or V _{SS}		4.0		4.0		30	μA	
V _{OL}	Low Level Output Voltage	I _O < 1 μA V _{DD} = 5V		0.05		0	0.05		0.05	V
		V _{DD} = 10V		0.05		0	0.05		0.05	V
		V _{DD} = 15V		0.05		0	0.05		0.05	V
V _{OH}	High Level Output Voltage	I _O < 1 μA V _{DD} = 5V	4.95		4.95	5		4.95		V
		V _{DD} = 10V	9.95		9.95	10		9.95		V
		V _{DD} = 15V	14.95		14.95	15		14.95		V
V _{IL}	Low Level Input Voltage	I _O < 1 μA V _{DD} = 5V, V _O = 4.5V or 0.5V		1.5			1.5		1.5	V
		V _{DD} = 10V, V _O = 9V or 1.0V		3.0			3.0		3.0	V
		V _{DD} = 15V, V _O = 13.5V or 1.5V		4.0			4.0		4.0	V
V _{IH}	High Level Input Voltage	I _O < 1 μA V _{DD} = 5V, V _O = 0.5V or 4.5V	3.5		3.5			3.5		V
		V _{DD} = 10V, V _O = 1V or 9.0V	7.0		7.0			7.0		V
		V _{DD} = 15V, V _O = 1.5V or 13.5V	11.0		11.0			11.0		V
I _{OL}	Low Level Output Current	V _{DD} = 5V, V _O = 0.4V	0.52		0.44	0.88		0.36		mA
		V _{DD} = 10V, V _O = 0.5V	1.3		1.1	2.25		0.9		mA
		V _{DD} = 15V, V _O = 1.5V	3.6		3.0	8.8		2.4		mA
I _{OH}	High Level Output Current	V _{DD} = 5V, V _O = 4.6V	-0.52		-0.44	-0.88		-0.36		mA
		V _{DD} = 10V, V _O = 9.5V	-1.3		-1.1	-2.25		-0.9		mA
		V _{DD} = 15V, V _O = 13.5V	-3.6		-3.0	-8.8		-2.4		mA
I _{IN}	Input Current	V _{DD} = 15V, V _{IN} = 0V		-0.3		-10 ⁻⁵	-0.3		-1.0	μA
		V _{DD} = 15V, V _{IN} = 15V		0.3		10 ⁻⁵	0.3		1.0	μA

AC Electrical Characteristics*

T_A = 25°C, C_L = 50 pF, R_L = 200k, t_r and t_f ≤ 20 ns, unless otherwise specified

Symbol	Parameter	Conditions	Min	Typ	Max	Units
t _{PHL} or t _{PLH}	Propagation Delay Time from Input to Output	V _{DD} = 5V V _{DD} = 10V V _{DD} = 15V		110 50 40	185 90 75	ns ns ns
t _{THL} or t _{TLH}	Transition Time	V _{DD} = 5V V _{DD} = 10V V _{DD} = 15V		100 50 40	200 100 80	ns ns ns
C _{IN}	Average Input Capacitance	Any Input		5	7.5	pF
C _{PD}	Power Dissipation Capacitance	Any Input (Note 4)		20		pF

*AC Parameters are guaranteed by DC correlated testing.

Note 1: "Absolute Maximum Ratings" are those values beyond which the safety of the device cannot be guaranteed. They are not meant to imply that the devices should be operated at these limits. The table of "Recommended Operating Conditions" and "Electrical Characteristics" provides conditions for actual device operation.

Note 2: V_{SS} = 0V unless otherwise specified.

Note 3: I_{OL} and I_{OH} are tested one output at a time.

Note 4: C_{PD} determines the no load AC power consumption of any CMOS device. For complete explanation, see 54C/74C Family Characteristics Application Note—AN-90.

AC Test Circuit and Switching Time Waveforms

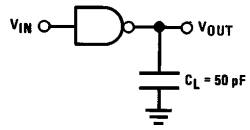

TL/F/5976-3

Note: Delays measured with input $t_r, t_f = 20 \text{ ns}$.

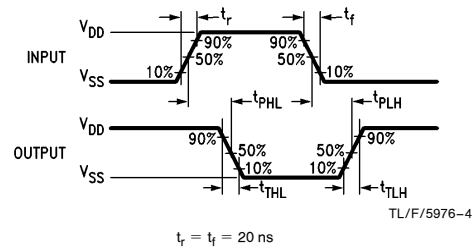

Physical Dimensions inches (millimeters)

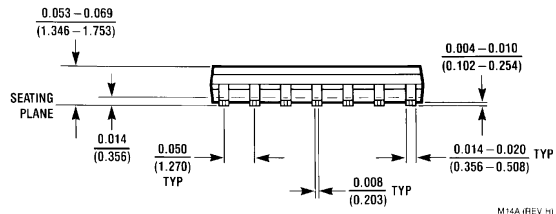
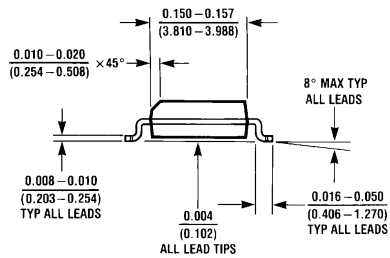
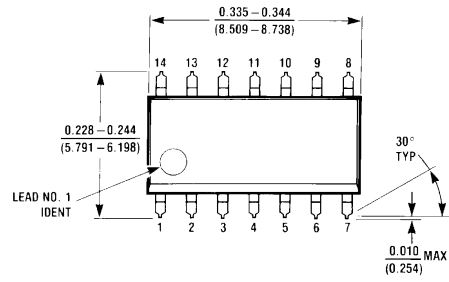

M14A (REV HI)

Molded Small Outline Package (M)
Order Number CD4070BCM or CD4077BCM
NS Package Number M14A

Physical Dimensions inches (millimeters) (Continued)

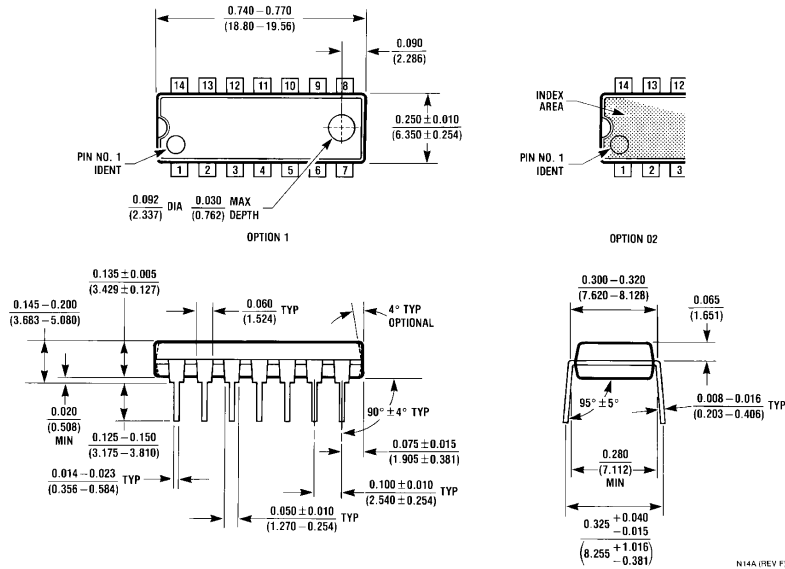

Molded Dual-In-Line Package (N)
Order Number CD4070BCN or CD4077BCN
NS Package Number N14A

LIFE SUPPORT POLICY

NATIONAL'S PRODUCTS ARE NOT AUTHORIZED FOR USE AS CRITICAL COMPONENTS IN LIFE SUPPORT DEVICES OR SYSTEMS WITHOUT THE EXPRESS WRITTEN APPROVAL OF THE PRESIDENT OF NATIONAL SEMICONDUCTOR CORPORATION. As used herein:

1. Life support devices or systems are devices or systems which, (a) are intended for surgical implant into the body, or (b) support or sustain life, and whose failure to perform, when properly used in accordance with instructions for use provided in the labeling, can be reasonably expected to result in a significant injury to the user.
2. A critical component is any component of a life support device or system whose failure to perform can be reasonably expected to cause the failure of the life support device or system, or to affect its safety or effectiveness.



National Semiconductor Corporation
 1111 West Bardin Road
 Arlington, TX 76017
 Tel: 1(800) 272-9959
 Fax: 1(800) 737-7018

National Semiconductor Europe
 Fax: (+49) 0-180-530 85 86
 Email: cnjwge@tevm2.nsc.com
 Deutsch Tel: (+49) 0-180-530 85 85
 English Tel: (+49) 0-180-532 78 32
 Français Tel: (+49) 0-180-532 93 58
 Italiano Tel: (+49) 0-180-534 16 80

National Semiconductor Hong Kong Ltd.
 19th Floor, Straight Block,
 Ocean Centre, 5 Canton Rd.
 Tsimshatsui, Kowloon
 Hong Kong
 Tel: (852) 2737-1600
 Fax: (852) 2736-9960

National Semiconductor Japan Ltd.
 Tel: 81-043-299-2309
 Fax: 81-043-299-2408

National does not assume any responsibility for use of any circuitry described, no circuit patent licenses are implied and National reserves the right at any time without notice to change said circuitry and specifications.