

L 367 200 11 P.C.B. connectors

► Expert Range - Insulation displacement connection (A.D.O.)

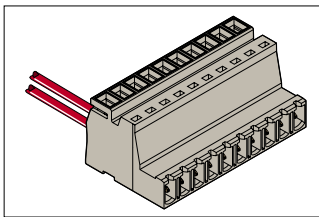

Male plug.

Wires parallel to connection.

Black marking to identify wire size range 1-2.5 mm².



Plug
TILE SHAPE

Body : UL94 V0 - PA
Grey



2.5 mm² - Spacing 7.62 mm .300"

Ordering details

N. Poles	Weight kg	Packaging	L. mm	Order code
2	0.0060	50	15.14	1SSA 367 202 R1100
3	0.0100	50	22.76	1SSA 367 203 R1100
4	0.0130	50	30.38	1SSA 367 204 R1100
5	0.0160	50	38.00	1SSA 367 205 R1100
6	0.0190	50	45.62	1SSA 367 206 R1100
10	0.0320	50	76.10	1SSA 367 210 R1100

Other numbers of poles, consult us

Technical data

	IEC	UL	CSA
Wire size			
Solid wire	1-2.5 mm ² *		
Stranded wire With ferrule	1-2.5 mm ² *		
Rated voltage	500 V		
Pollution degree	3		
Rated current	22 A		
Short-circuit current			
Rated wire size / Gauge	2.5 mm ²		
Storage temperature range		-20 ~ +80 °C	
Insulation resistance		≥ 10 ⁹ Ω	
Wire stripping length			
Recommended screwdriver			
Protection		IP 20 / NEMA 1	

* 1 or 2 wires (same wire size) per A.D.O. jaw.

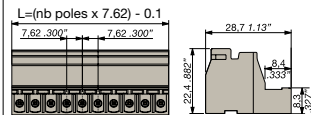

Plug L 367 200 11 compatible with :

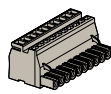

L 266 200 11

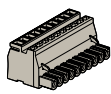

L 267 200 11

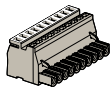

L 276 200 11

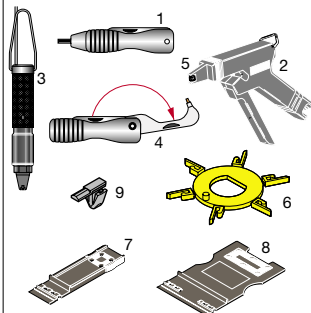

Accessories

Rep.	Description	Type	Order code	Spacing	Packaging	Weight kg
1	Manual tool	OUMAD	1SNA 179 466 R0600		1	0.0290
2	Semi-automatic tool	OUPAD	1SNA 178 944 R0400		1	0.2050
3	Pneumatic tool	OUTAD	1SNA 205 710 R1100		1	0.5000
4	Extraction tool	EXAD2	1SNA 205 721 R0000		1	0.0290
5	Removable head kit	OUTA	1SNA 205 284 R0300		1	0.0290
6	Coding peg	yellow ■ COCE	1SNA 199 321 R0100		10	0.0010
7	Cable clamp plug	3 poles black ■ PT1	1SSS 299 253 R2200	7.62 mm	20	0.0016
8	Cable clamp plug	8 poles black ■ PT2	1SSS 299 254 R2200	7.62 mm	20	0.0018
9	Snap in mounting foot	grey □	1SSA 299 257 R0000		20	0.0001

Other versions, please consult us :

Male plugs with brackets. Black marking to identify wire size range 1-2.5 mm².

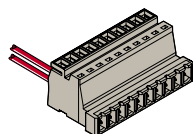

L 367 200 21

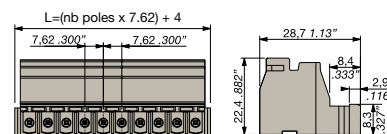

Male plugs with flanges and inserts. Black marking to identify wire size range 1-2.5 mm².

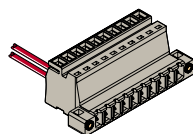

L 367 200 31

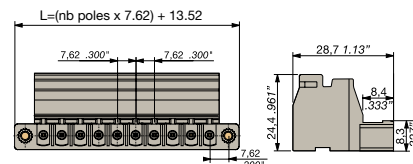

Male plugs with flanges and inserts. Black marking to identify wire size range 1-2.5 mm².

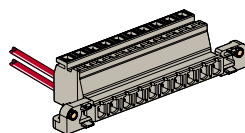

L 367 200 41

