

M/A-COM's line of SMB connectors offers an inexpensive alternative in miniature RF interconnects where packaging density is critical. M/A-COM applies many of the same design standards of their highly reliable OSM (SMA) series to the SMB series. For instance, M/A-COM uses only beryllium copper center contacts for increased durability.

Table of Contents

	Page
Interface Mating Dimensions	240
Specifications	241
Flexible Cable Type	242
Clamp Attachment	
Crimp Attachment	
Panel and Bulkhead Mount Receptacle	244
Straight Terminal	
Printed Circuit Board	
In-Series Adapters	247
Between-Series Adapters	248
SMC Subminiature Coaxial Connectors	250

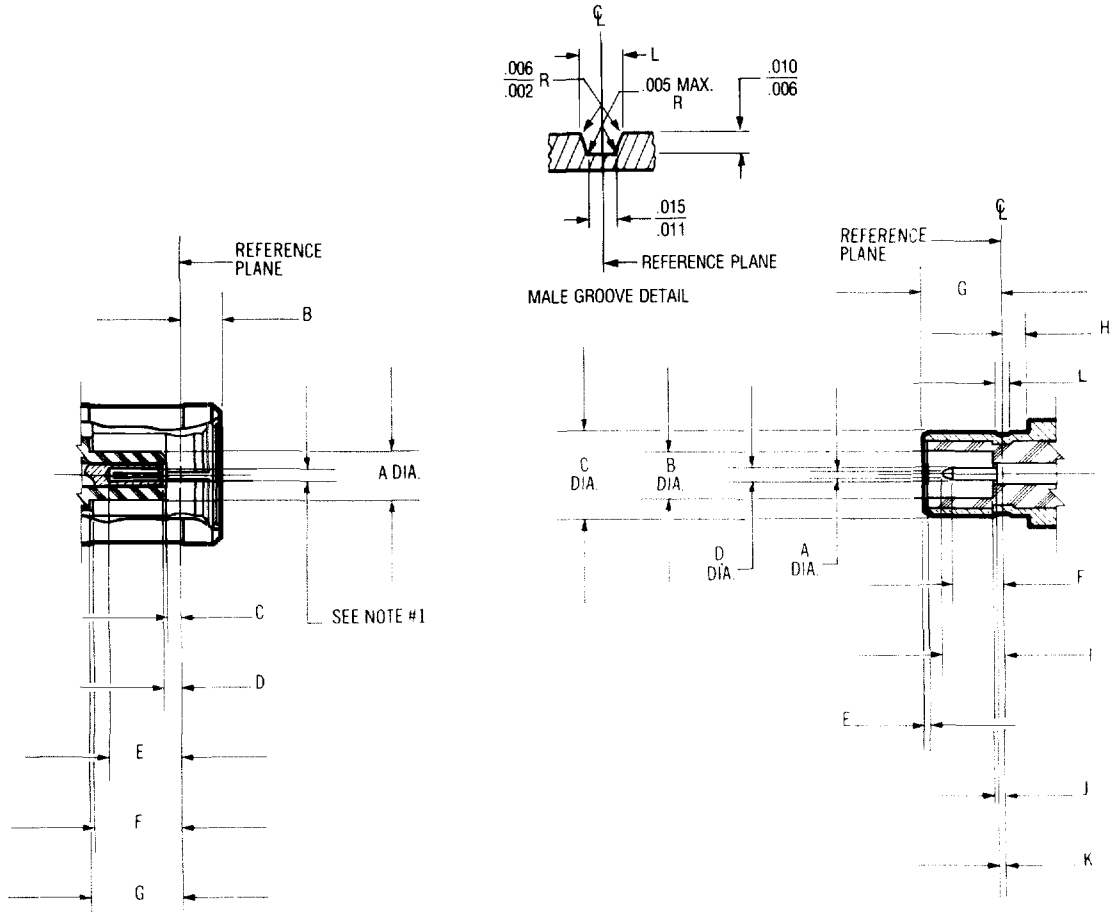

FEMALE

Letter	Inches (Millimeters) ²	
	Minimum	Maximum
A	-	.081 (2.06)
B	-	.064 (1.63)
C	.007 (0.18)	-
D	.007 (0.18)	.037 (0.94)
E	.117 (2.97)	-
F	.141 (3.58)	-
G	.141 (3.58)	-

MALE

Letter	Inches (Millimeters) ²	
	Minimum	Maximum
A	-	.010 (0.25)
B	.082 (2.08)	.085 (2.16)
C	-	.146 (3.71)
D	.019 (0.48)	.021 (0.53)
E	.000 (0.00)	-
F	.052 (1.32)	-
G	.131 (3.33)	.141 (3.58)
H	.065 (1.65)	-
I	-	.117 (2.97)
J	-	.007 (0.18)
K	-	.007 (0.18)
L	.027 (0.69)	.037 (0.94)

1. ID to meet VSWR and contact resistance when mated with .020 ± .001 (508 ± .0254mm) dia. pin.
 2. Metric equivalents (to the nearest 0.01mm) are given for general information only.



Specifications

Requirement	Detail
-------------	--------

General

Material	Brass per QQ-B-626, Comp. 360, half hard. Beryllium copper per ASTM-B-196 PTFE fluoro carbon per ASTM-D-1457.
Finish	Center contacts shall be gold plated to a min. thickness of .0001 inch in accordance with MIL-G-45204, Type I, Grade C. All other metal parts shall be finished as to provide a connector which meets the corrosion requirements.
Design	The design shall be such that the outline and interface dimensions shown in this catalog are met.

Electrical

Frequency	dc to 4 GHz.												
Insulation Resistance	1,000 megohms min.												
Corona Level at 70,000 ft.	RG 178 cable or equivalent 185 volts min. RG 316 cable or equivalent 250 volts min.												
Dielectric Withstanding Voltage At Sea Level	Straight connector, non-cabled, 1,000 volts. RG 178 cable or equivalent 750 volts. RG 316 cable or equivalent 1,000 volts.												
RF High Potential at 5 MHz	Straight connector, solder pot, 600 volts RMS. RG 178 cable or equivalent 500 volts RMS. RG 316 cable or equivalent 700 volts RMS.												
Voltage Rating	<table border="0"> <tr> <td></td> <td>Sea Level</td> <td>70,000 Ft.</td> </tr> <tr> <td>Straight connector, non-cabled</td> <td>335 volts</td> <td>85 volts.</td> </tr> <tr> <td>RG 178 cable or equivalent</td> <td>250 volts</td> <td>60 volts.</td> </tr> <tr> <td>RG 316 cable or equivalent</td> <td>335 volts</td> <td>85 volts.</td> </tr> </table>		Sea Level	70,000 Ft.	Straight connector, non-cabled	335 volts	85 volts.	RG 178 cable or equivalent	250 volts	60 volts.	RG 316 cable or equivalent	335 volts	85 volts.
	Sea Level	70,000 Ft.											
Straight connector, non-cabled	335 volts	85 volts.											
RG 178 cable or equivalent	250 volts	60 volts.											
RG 316 cable or equivalent	335 volts	85 volts.											
Center Contact Resistance	Straight connector 6.0 milliohms. Right angle connector 12.0 milliohms.												
VSWR	Straight connector RG 178 cable or equivalent 1.20 + .04f(GHz). Straight connector RG 316 cable or equivalent 1.15 + .04f(GHz). Right angle connector RG 178 cable or equivalent 1.35 + .06f(GHz). Right angle connector RG 316 cable or equivalent 1.25 + .04f(GHz).												
Insertion Loss	Straight cable connector .30 dB max. at 1.5 GHz. Right angle cable connector .60 dB max. at 1.5 GHz.												

Mechanical

Force to Engage	The torque requirement to engage and disengage is not applicable. Longitudinal force is 14 lbs. max.
Mating Characteristics	Applicable to female connectors only. Oversize test pin .021 min. dia., .045 deep; insertion force 2.5 lbs. max. with .021 min. dia. pin; withdrawal force 1 oz. min. with .019 max. dia. pin.
Connector Durability	500 insertion and withdrawal cycles at 12 cycles per minute max.

Environmental

Temperature Range	-65°C to +165°C.
Vibration	Per MIL-STD-202, method 204, test condition D.
Shock	Per MIL-STD-202, method 213, test condition B.
Corrosion (Salt Spray)	Per MIL-STD-202, method 101, test condition B.



For Flexible Cable

Crimp Attachment Straight Cable Plug

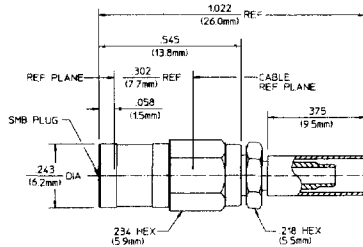
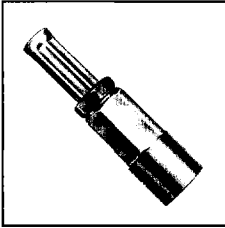

Captured Center Contact		
Cable	RG174/U, 188, 316	RG/178/U, 196
Part Number	5131-5007-09	5131-5011-09

Finish: Gold plate. For nickel plate, change the Part number from -09 to -10.
Refer to Appendix for Coaxial Cable Characteristics

Straight Cable Jack

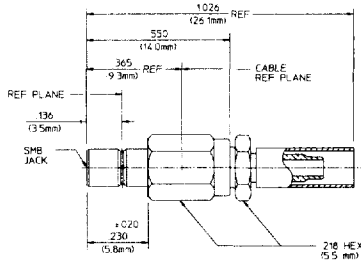
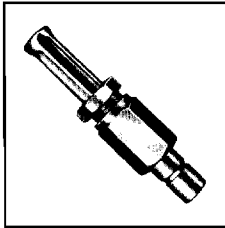

Captured Center Contact		
Cable	RG174/U, 188, 316	RG/178/U, 196
Part Number	5132-5001-09	5132-5003-09

Finish: Gold plate. For nickel plate, change the Part number from -09 to -10.
Refer to Appendix for Coaxial Cable Characteristics

Bulkhead Feedthrough Cable Jack

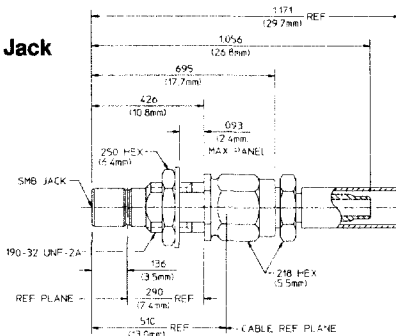
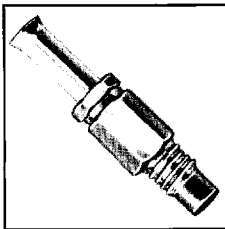

Captured Center Contact		
Cable	RG174/U, 188, 316	RG/178/U, 196
Part Number	5134-5002-09	5134-7196-09

Finish: Gold plate. For nickel plate, change the Part number from -09 to -10.
Refer to Appendix for Coaxial Cable Characteristics

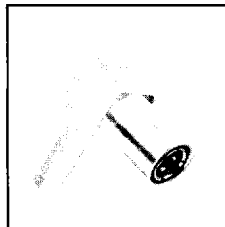

Right Angle Cable Plug

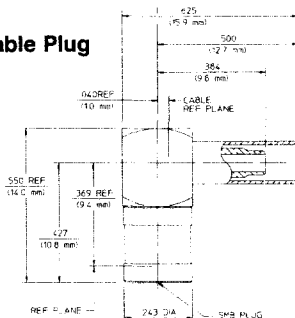

Captured Center Contact		
Cable	RG174/U, 188, 316	RG/178/U, 196
Part Number	5137-5010-09	5137-5011-09

Finish: Gold plate. For nickel plate, change the Part number from -09 to -10.
Refer to Appendix for Coaxial Cable Characteristics

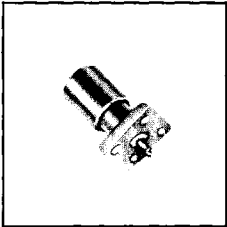

Flange Mount Plug Receptacle

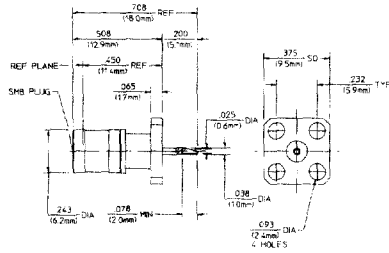

Captured Center Contact
Solder Pot Terminal

Part Number 5151-0000-09

Finish: Gold plate. For nickel plate, change the Part number from -09 to -10.

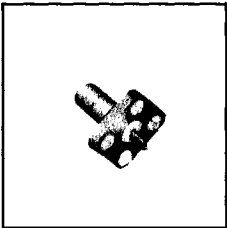

Flange Mount Jack Receptacle

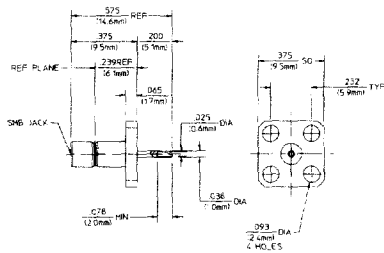

Captured Center Contact
Solder Pot Terminal

Part Number 5152-0000-09

Finish: Gold plate. For nickel plate, change the Part number from -09 to -10.



Panel Mount Receptacles

Rear Mount Bulkhead Feedthrough Jack Receptacle

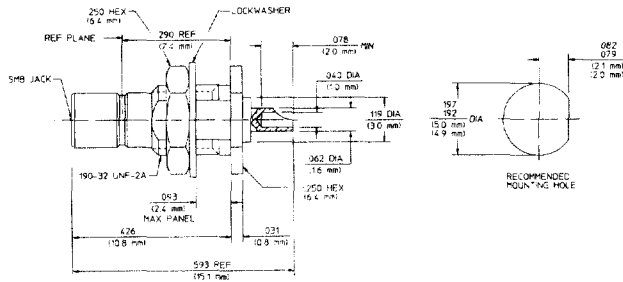
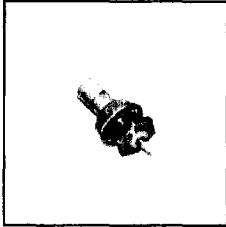

Captured Center Contact Solder Pot Terminal	
Part Number	5156-0000-09

Finish: Gold plate. For nickel plate, change the Part number from -09 to -10.

Front Mount Bulkhead Feedthrough Jack Receptacle

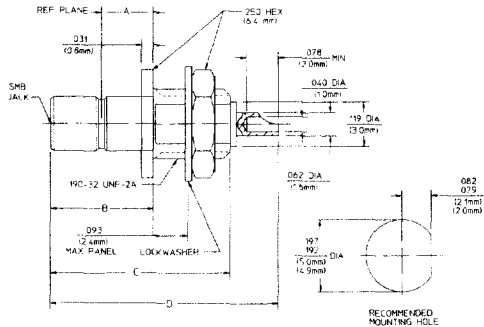
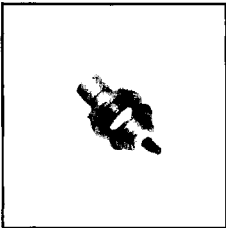

Captured Center Contact Solder Pot Terminal			
Part Number	5158-5010-09	5158-0000-09	
Dim. A	Inches (mm)	Inches (mm)	
	.138 Ref. (3.5)	.110 Ref. (2.8)	
Dim. B	.274 (7.0)	.244 (6.2)	
Dim. C	.480 (12.2)	.457 (11.6)	
Dim. D	.609 Ref. (15.5)	.593 Ref. (15.1)	

Finish: Gold plate. For nickel plate, change the Part number from -09 to -10.

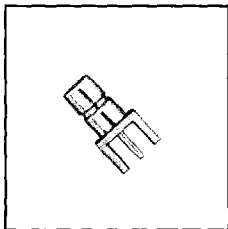

Straight Jack Receptacle

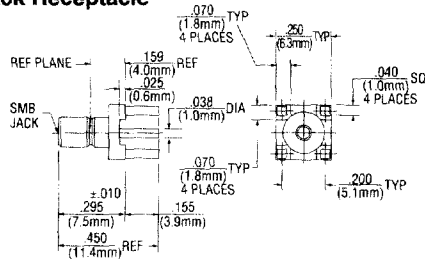

Part Number 5162-5013-09

Finish: Gold plate. For nickel plate, change the Part number from -09 to -10.

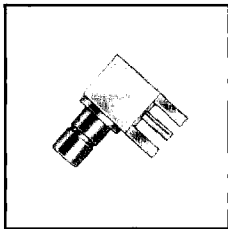

Right Angle Jack Receptacle

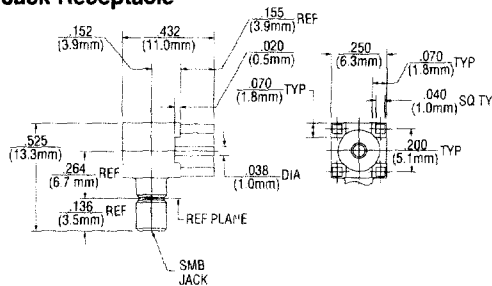

Part Number 5164-5003-09

Finish: Gold plate. For nickel plate, change the Part number from -09 to -10.

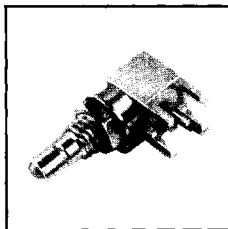

Right Angle Bulkhead Feedthrough Jack Receptacle

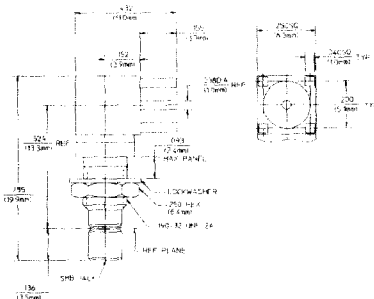

Part Number 5164-5011-09

Finish: Gold plate. For tin lead, change the Part number from -09 to -13

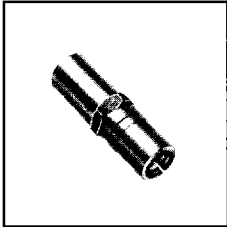

Plug to Plug

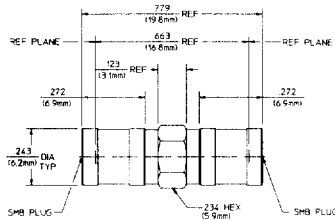

Part Number	5181-0000-09
--------------------	---------------------

Finish: Gold plate. For nickel plate, change the Part number from -09 to -10.

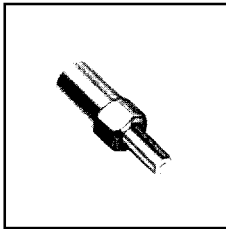

Plug to Jack

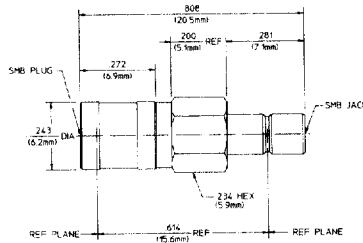

Part Number	5182-0000-09
--------------------	---------------------

Finish: Gold plate. For nickel plate, change the Part number from -09 to -10.

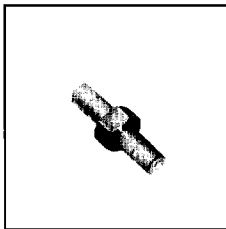

Jack to Jack

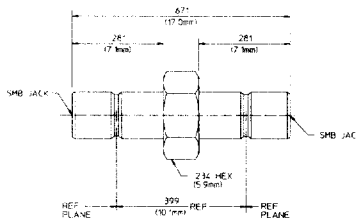

Part Number	5180-0000-09
--------------------	---------------------

Finish: Gold plate. For nickel plate, change the Part number from -09 to -10.

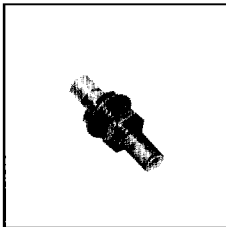

Bulkhead Feedthrough Jack to Jack

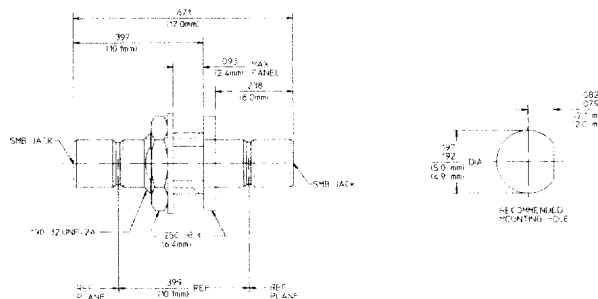

Part Number	5184-0000-09
--------------------	---------------------

Finish: Gold plate. For nickel plate, change the Part number from -09 to -10.

SMB to OSM(SMA)

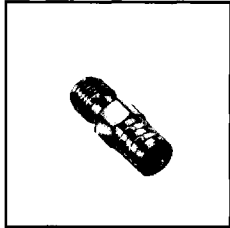

SMB Plug to OSM Jack

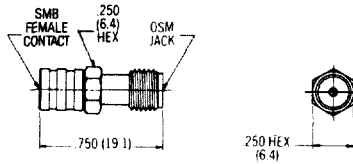

Finish: Passivated stainless steel.

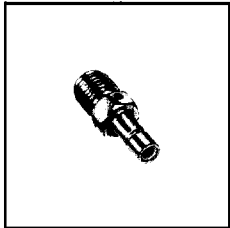

SMB Jack to OSM Jack

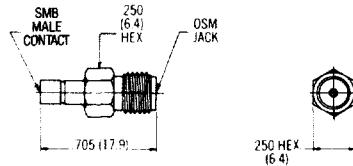

Finish: Passivated stainless steel.

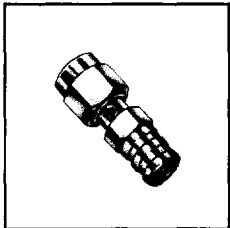

SMB Plug to OSM Plug

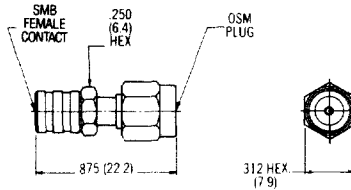

Finish: Passivated stainless steel.

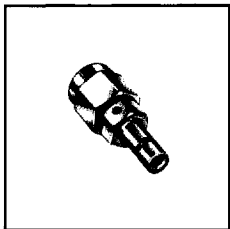

SMB Jack to OSM Plug

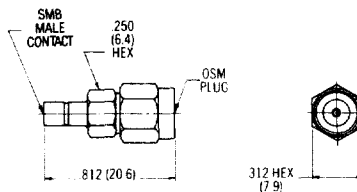

Finish: Passivated stainless steel.

SMB

Between-Series Adapters

SMB to BNC

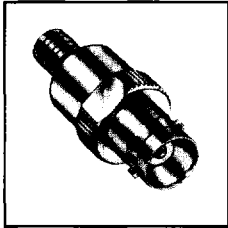

SMB Plug to BNC Jack

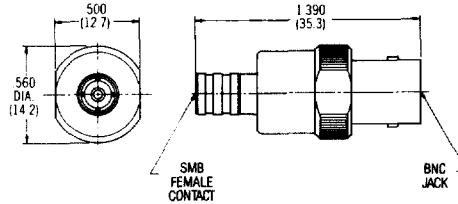

Part Number 3282-2223-00

Finish: BNC: Nickel plated brass,
SMB: Passivated stainless steel

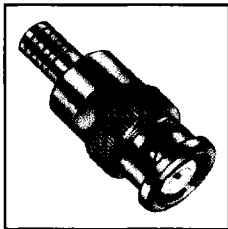

SMB Plug to BNC Plug

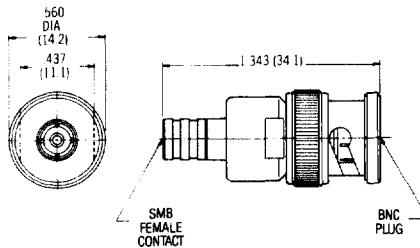

Part Number 3281-2223-00

Finish: BNC: Nickel plated brass,
SMB: Passivated stainless steel

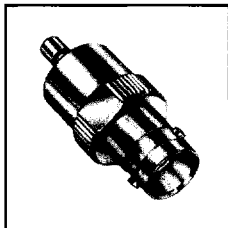

SMB Jack to BNC Jack

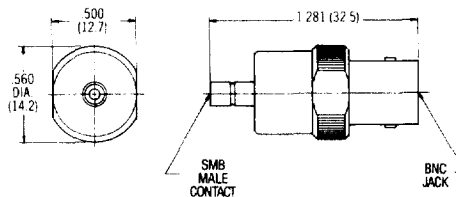

Part Number 3280-2224-00

Finish: BNC: Nickel plated brass,
SMB: Passivated stainless steel

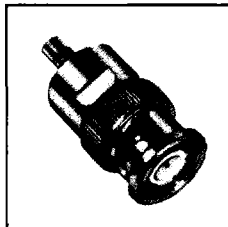

SMB Jack to BNC Plug

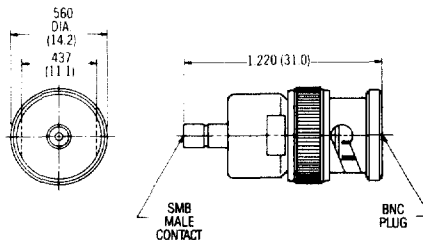

Part Number 3282-2224-00

Finish: BNC: Nickel plated brass,
SMB: Passivated stainless steel