

**HIGH CMR, 10 Mbps OPEN COLLECTOR OUTPUT TYPE
5-PIN SOP PHOTOCOUPLER**

-NEPOC Series-

DESCRIPTION

The PS9714 is an optically coupled high-speed, isolator containing a GaAlAs LED on the input side and a photodiode and a signal processing circuit on the output side on one chip.

FEATURES

- High common mode transient immunity ($CM_H, CML = \pm 20 \text{ kV}/\mu\text{s}$ TYP.)
- Pulse width distortion ($|t_{PHL} - t_{PLH}| = 3 \text{ ns}$ TYP.)
- Small package (5-pin SOP)
- High-speed (10 Mbps)
- High isolation voltage ($BV = 2\,500 \text{ Vr.m.s.}$)
- Open collector output
- Ordering number of taping product: PS9714-F3, F4: 3 500 pcs/reel
- Safety standards
 - UL approved: File No. E72422 (S)
 - VDE0884 approved (Option)

APPLICATIONS

- Measurement equipment
- PDP
- FA Network

The information in this document is subject to change without notice. Before using this document, please confirm that this is the latest version.
Not all devices/types available in every country. Please check with local NEC Compound Semiconductor Devices representative for availability and additional information.

PACKAGE DIMENSIONS (UNIT: mm)

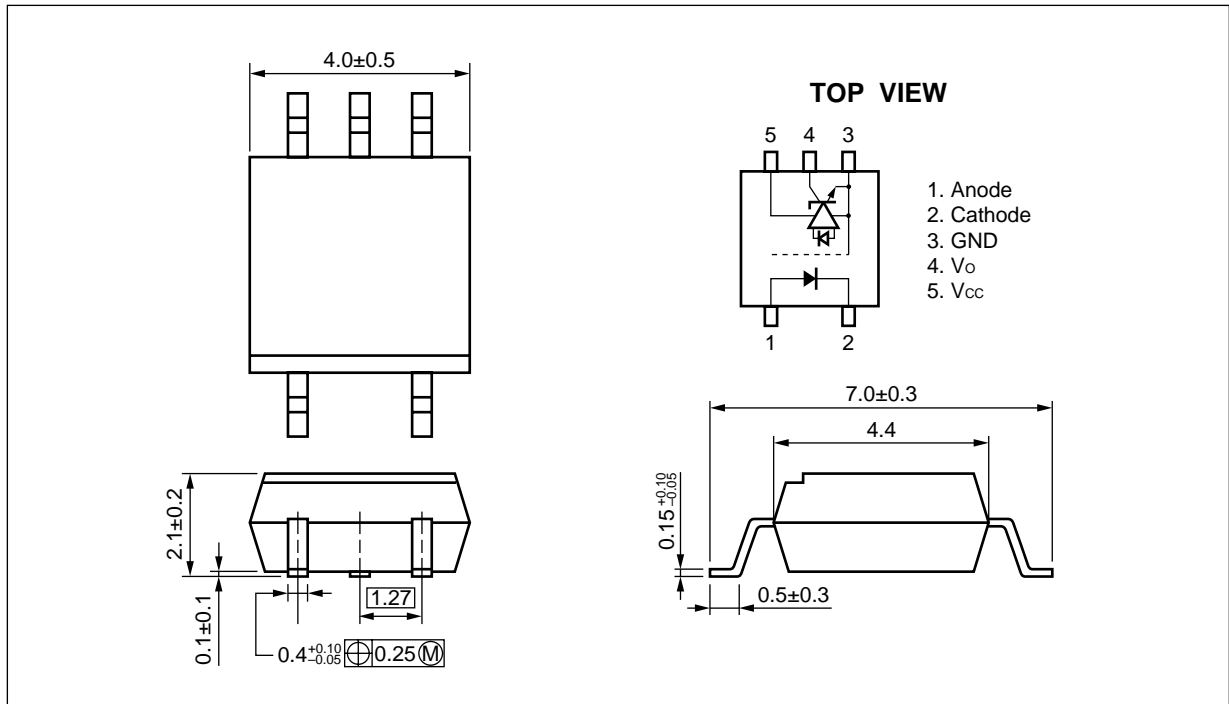

MARKING

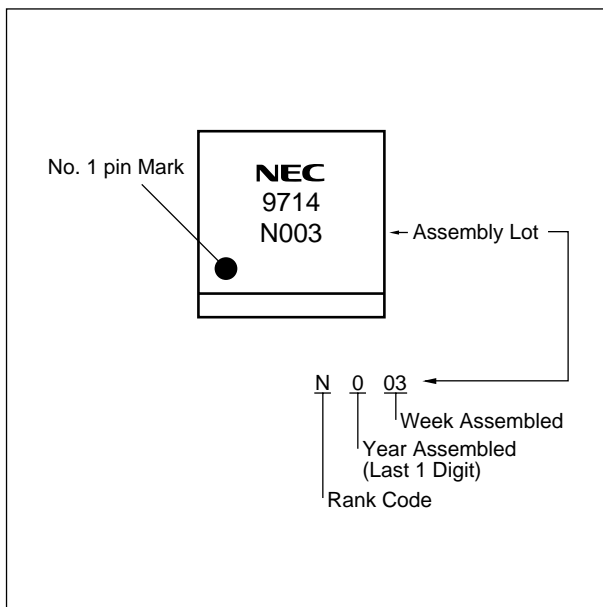

ORDERING INFORMATION

Part Number	Package	Packing Style	Safety Standards Approval	Application Part Number ^{*1}
PS9714	5-pin SOP	Magazine case 100 pcs	UL approved	PS9714
PS9714-F3		Embossed Tape 3 500 pcs/reel		
PS9714-F4			VDE0884 approved	
PS9714-V		Magazine case 100 pcs		
PS9714-V-F3		Embossed Tape 3 500 pcs/reel		
PS9714-V-F4				

*1 For the application of the Safety Standard, following part number should be used.

ABSOLUTE MAXIMUM RATINGS (T_A = 25°C, unless otherwise specified)

Parameter		Symbol	Ratings	Unit
Diode	Forward Current	I _F	30	mA
	Reverse Voltage	V _R	3	V
Detector	Supply Voltage	V _{CC}	7	V
	Output Voltage	V _O	7	V
	Output Current	I _O	25	mA
	Power Dissipation ^{*1}	P _C	40	mW
Isolation Voltage ^{*2}		BV	2 500	Vr.m.s.
Operating Ambient Temperature		T _A	-40 to +85	°C
Storage Temperature		T _{stg}	-55 to +125	°C

*1 Applies to output pin V_O. Reduced to 1.5 mW/°C at T_A = 65°C or more.

*2 AC voltage for 1 minute at T_A = 25°C, RH = 60% between input and output.

RECOMMENDED OPERATING CONDITIONS

Parameter	Symbol	MIN.	TYP.	MAX.	Unit
Low Level Input Voltage	V _{FL}	0		0.8	V
High Level Input Current	I _{FH}	6.3		12.5	mA
Supply Voltage	V _{CC}	4.5	5.0	5.5	V
TTL (R _L = 1 kΩ, loads)	N			5	
Pull-up resistor	R _L	330		4 k	Ω

ELECTRICAL CHARACTERISTICS (T_A = -40 to +85°C, unless otherwise specified)

Parameter		Symbol	Conditions	MIN.	TYP. ^{*1}	MAX.	Unit
Diode	Forward Voltage	V _F	I _F = 10 mA, T _A = 25°C	1.4	1.65	1.9	V
	Reverse Current	I _R	V _R = 3 V, T _A = 25°C			10	μA
	Terminal Capacitance	C _t	V = 0 V, f = 1 MHz, T _A = 25°C		30		pF
Detector	High Level Output Current	I _{OH}	V _{CC} = V _O = 5.5 V, V _F = 0.8 V		0.02	250	μA
	Low Level Output Voltage ^{*2}	V _{OL}	V _{CC} = 5.5 V, I _F = 5 mA, I _{OL} = 13 mA		0.15	0.6	V
	High Level Supply Current	I _{CCH}	V _{CC} = 5.5 V, I _F = 0 mA		3	8	mA
	Low Level Supply Current	I _{CCL}	V _{CC} = 5.5 V, I _F = 10 mA		7.0	11	mA
Coupled	Threshold Input Current (H → L)	I _{FHL}	V _{CC} = 5 V, V _O = 0.8 V, R _L = 350 Ω		2	5	mA
	Isolation Resistance	R _{I-O}	V _{I-O} = 1 kV _{DC} , R _H = 40 to 60%, T _A = 25°C	10 ¹¹			Ω
	Isolation Capacitance	C _{I-O}	V = 0 V, f = 1 MHz, T _A = 25°C		0.9		pF
	Propagation Delay Time (H → L) ^{*3}	t _{PHL}	T _A = 25°C		54	75	ns
			V _{CC} = 5 V, R _L = 350 Ω, I _F = 7.5 mA			100	
	Propagation Delay Time (L → H) ^{*3}	t _{PLH}	T _A = 25°C		51	75	ns
			V _{CC} = 5 V, R _L = 350 Ω, I _F = 7.5 mA			100	
	Rise Time	t _r	V _{CC} = 5 V, R _L = 350 Ω, I _F = 7.5 mA		20		
	Fall Time	t _f	V _{CC} = 5 V, R _L = 350 Ω, I _F = 7.5 mA		10		
	Pulse Width Distortion (PWD) ^{*3}	t _{PHL} - t _{PLH}	V _{CC} = 5 V, R _L = 350 Ω, I _F = 7.5 mA		3	50	ns
	Propagation Delay Skew	t _{PSK}	V _{CC} = 5 V, R _L = 350 Ω, I _F = 7.5 mA			60	
Common Mode Transient Immunity at High Level Output ^{*4}	CM _H	R _L = 350 Ω, T _A = 25°C, I _F = 0 mA, V _{O(MIN)} = 2 V, V _{CM} = 1 kV	10	20		kV/μs	
Common Mode Transient Immunity at Low Level Output ^{*4}	CM _L	R _L = 350 Ω, T _A = 25°C, I _F = 7.5 mA, V _{O(MAX)} = 0.8 V, V _{CM} = 1 kV	10	20		kV/μs	

*1 Typical values at $T_A = 25^\circ\text{C}$

*2 Because V_{OL} of 2 V or more may be output when LED current input and when output supply of $V_{CC} = 2.6\text{ V}$ or less, it is important to confirm the characteristics (operation with the power supply on and off) during design, before using this device.

*3 Test circuit for propagation delay time

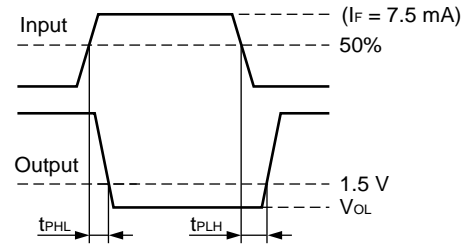
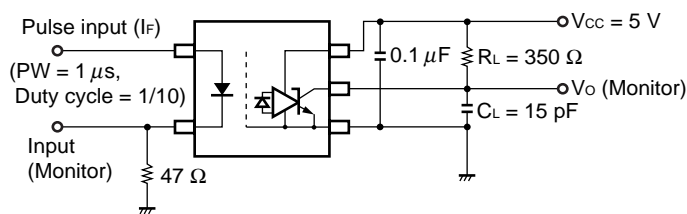

Remark C_L includes probe and stray wiring capacitance.

*4 Test circuit for common mode transient immunity

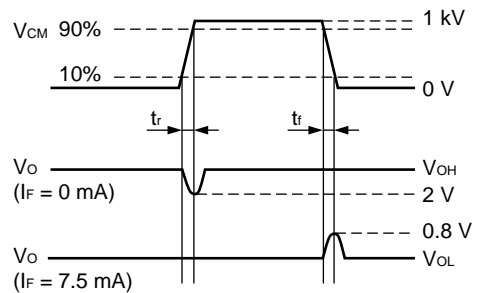
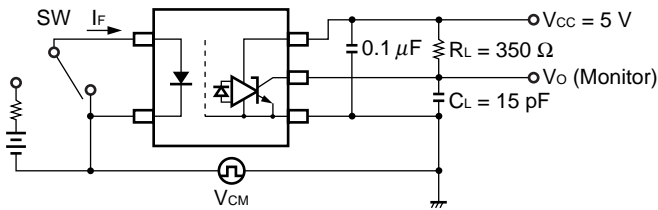

Remark C_L includes probe and stray wiring capacitance.

USAGE CAUTIONS

1. This product is weak for static electricity by designed with high-speed integrated circuit so protect against static electricity when handling.
2. By-pass capacitor of more than $0.1\ \mu\text{F}$ is used between V_{CC} and GND near device. Also, ensure that the distance between the leads of the photocoupler and capacitor is no more than 10 mm.

TYPICAL CHARACTERISTICS ($T_A = 25^\circ\text{C}$, unless otherwise specified)

MAXIMUM FORWARD CURRENT vs. AMBIENT TEMPERATURE

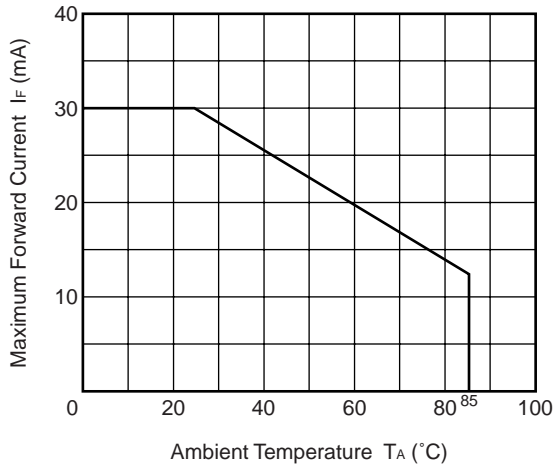

DETECTOR POWER DISSIPATION vs. AMBIENT TEMPERATURE

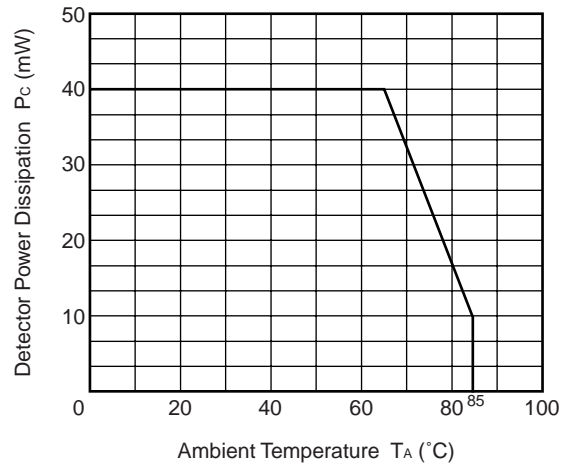

FORWARD CURRENT vs. FORWARD VOLTAGE

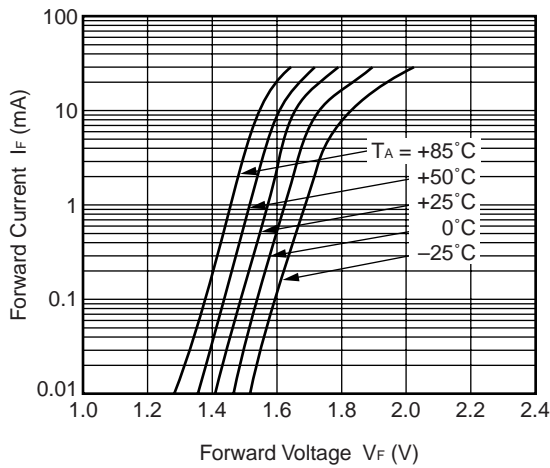

SUPPLY CURRENT vs. AMBIENT TEMPERATURE

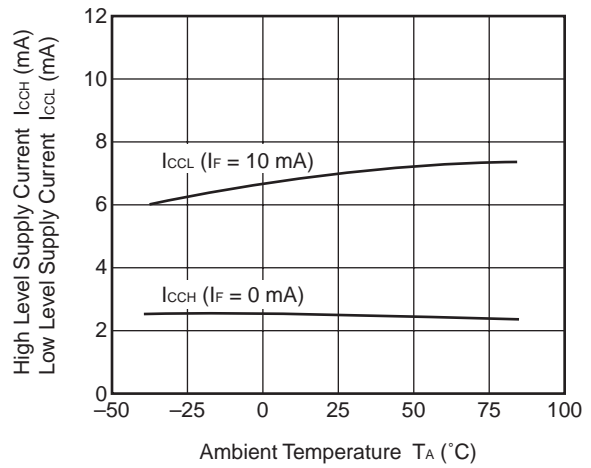

OUTPUT VOLTAGE vs. INPUT CURRENT

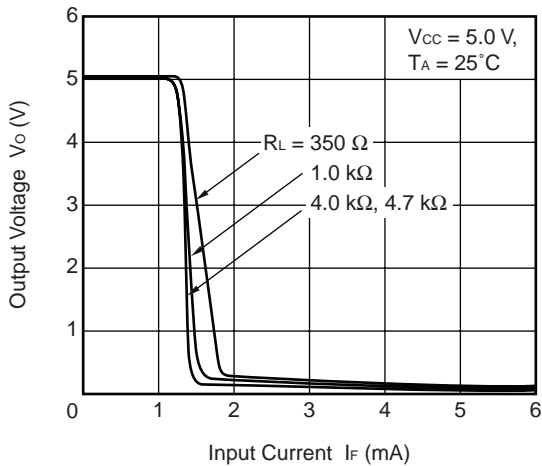

LOW LEVEL OUTPUT VOLTAGE vs. AMBIENT TEMPERATURE

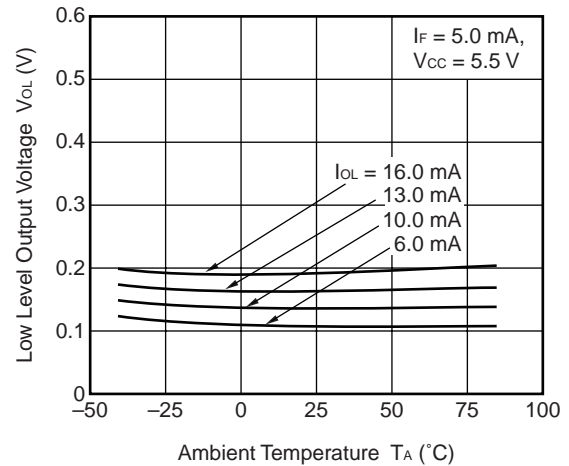

THRESHOLD INPUT CURRENT vs. AMBIENT TEMPERATURE

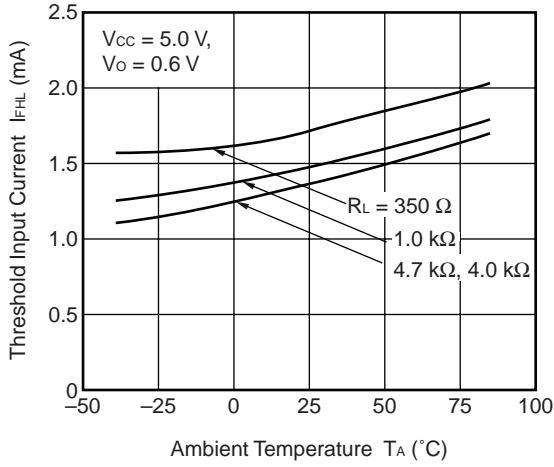

PROPAGATION DELAY TIME vs. AMBIENT TEMPERATURE

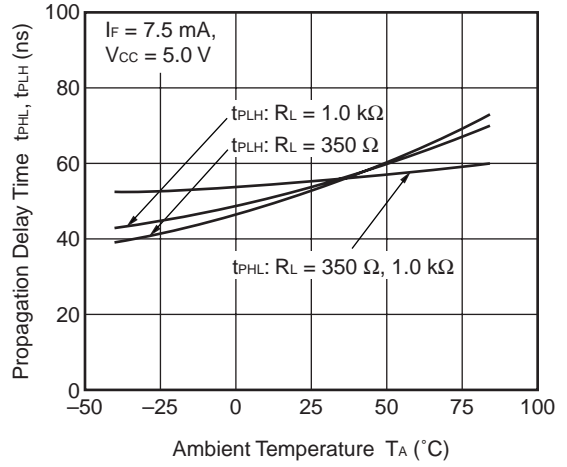

PROPAGATION DELAY TIME vs. AMBIENT TEMPERATURE

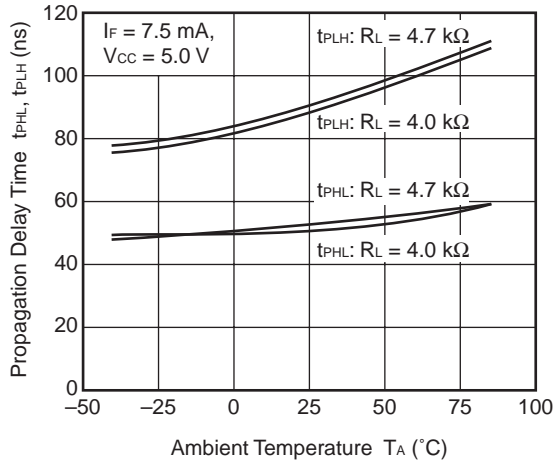

PULSE WIDTH DISTORTION vs. AMBIENT TEMPERATURE

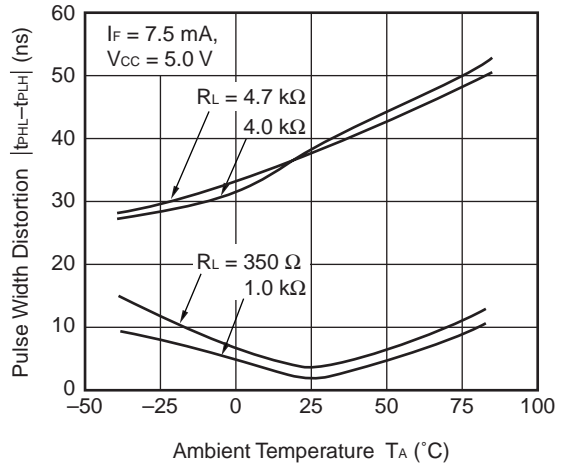

SWITCHING TIME vs. AMBIENT TEMPERATURE

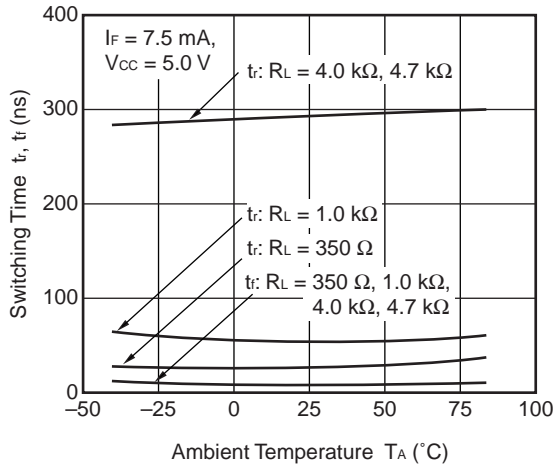

PROPAGATION DELAY TIME vs. INPUT CURRENT

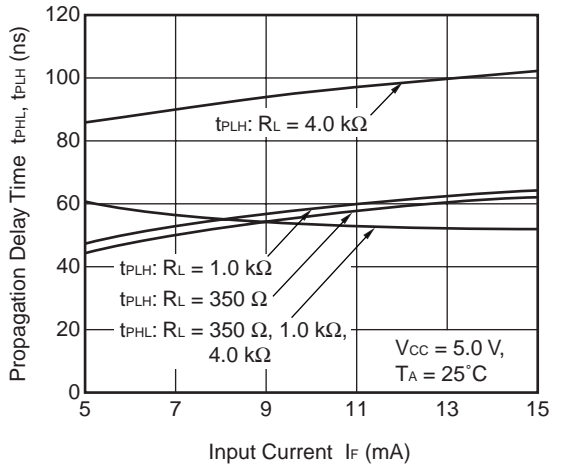

Remark The graphs indicate nominal characteristics.

TAPING SPECIFICATIONS (UNIT: mm)

Outline and Dimensions (Tape)

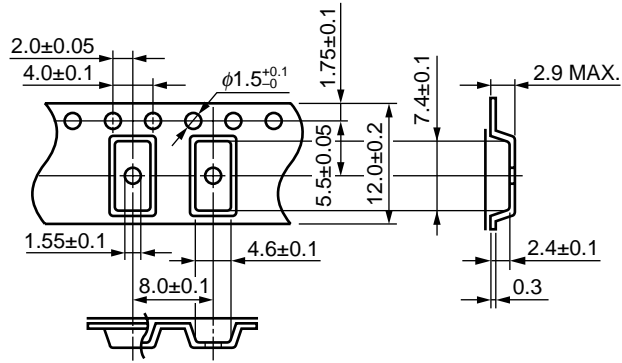

Tape Direction

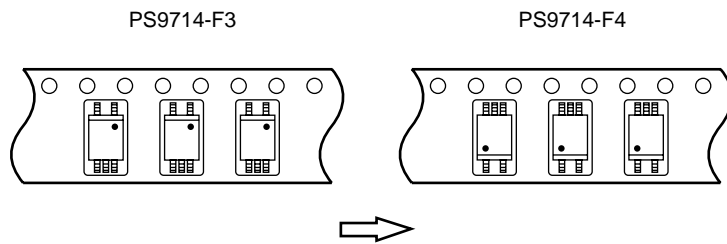

Outline and Dimensions (Reel)

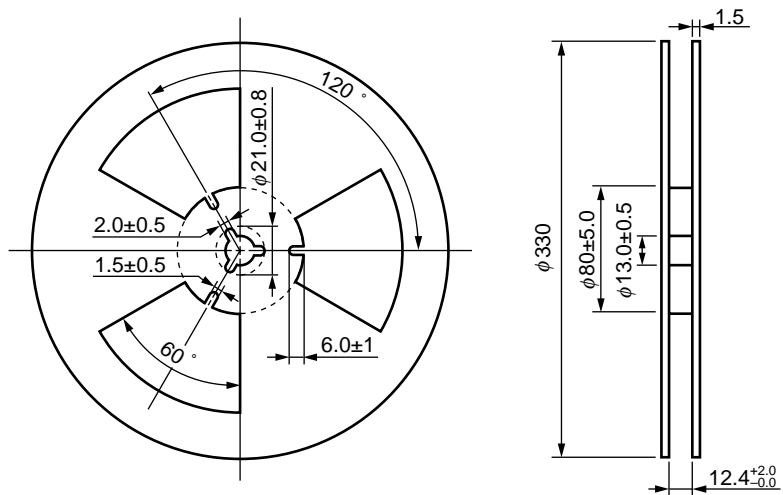

Packing: 3 500 pcs/reel

RECOMMENDED SOLDERING CONDITIONS

(1) Infrared reflow soldering

- Peak reflow temperature 235°C or below (package surface temperature)
- Time of temperature higher than 210°C 30 seconds or less
- Number of reflows Three
- Flux Rosin flux containing small amount of chlorine (The flux with a maximum chlorine content of 0.2 Wt % is recommended.)

Recommended Temperature Profile of Infrared Reflow

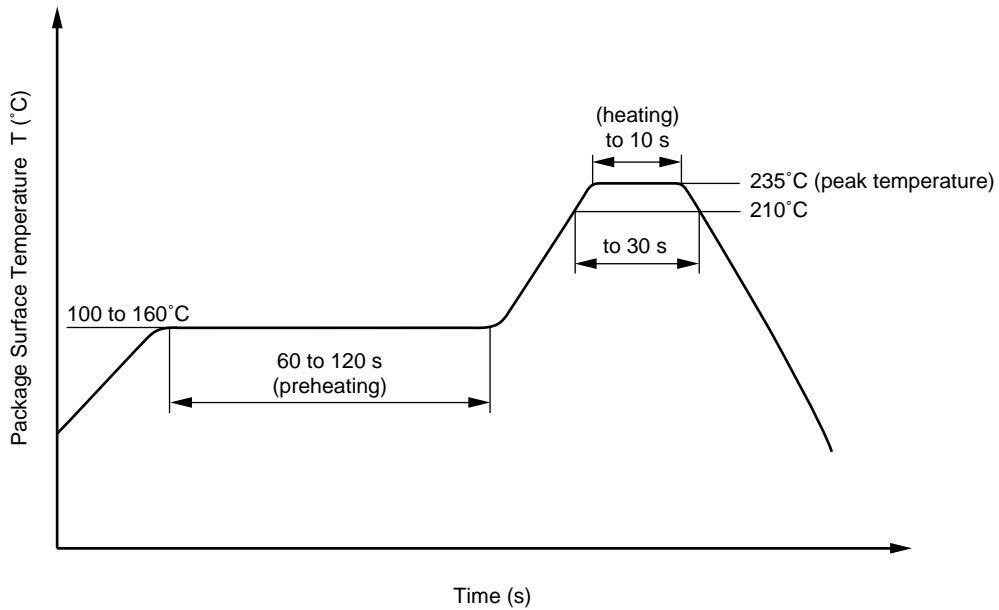

(2) Cautions

- Fluxes
Avoid removing the residual flux with freon-based and chlorine-based cleaning solvent.

- **The information in this document is current as of December, 2001. The information is subject to change without notice. For actual design-in, refer to the latest publications of NEC's data sheets or data books, etc., for the most up-to-date specifications of NEC semiconductor products. Not all products and/or types are available in every country. Please check with an NEC sales representative for availability and additional information.**
 - No part of this document may be copied or reproduced in any form or by any means without prior written consent of NEC. NEC assumes no responsibility for any errors that may appear in this document.
 - NEC does not assume any liability for infringement of patents, copyrights or other intellectual property rights of third parties by or arising from the use of NEC semiconductor products listed in this document or any other liability arising from the use of such products. No license, express, implied or otherwise, is granted under any patents, copyrights or other intellectual property rights of NEC or others.
 - Descriptions of circuits, software and other related information in this document are provided for illustrative purposes in semiconductor product operation and application examples. The incorporation of these circuits, software and information in the design of customer's equipment shall be done under the full responsibility of customer. NEC assumes no responsibility for any losses incurred by customers or third parties arising from the use of these circuits, software and information.
 - While NEC endeavours to enhance the quality, reliability and safety of NEC semiconductor products, customers agree and acknowledge that the possibility of defects thereof cannot be eliminated entirely. To minimize risks of damage to property or injury (including death) to persons arising from defects in NEC semiconductor products, customers must incorporate sufficient safety measures in their design, such as redundancy, fire-containment, and anti-failure features.
 - NEC semiconductor products are classified into the following three quality grades:
 "Standard", "Special" and "Specific". The "Specific" quality grade applies only to semiconductor products developed based on a customer-designated "quality assurance program" for a specific application. The recommended applications of a semiconductor product depend on its quality grade, as indicated below. Customers must check the quality grade of each semiconductor product before using it in a particular application.
 "Standard": Computers, office equipment, communications equipment, test and measurement equipment, audio and visual equipment, home electronic appliances, machine tools, personal electronic equipment and industrial robots
 "Special": Transportation equipment (automobiles, trains, ships, etc.), traffic control systems, anti-disaster systems, anti-crime systems, safety equipment and medical equipment (not specifically designed for life support)
 "Specific": Aircraft, aerospace equipment, submersible repeaters, nuclear reactor control systems, life support systems and medical equipment for life support, etc.
- The quality grade of NEC semiconductor products is "Standard" unless otherwise expressly specified in NEC's data sheets or data books, etc. If customers wish to use NEC semiconductor products in applications not intended by NEC, they must contact an NEC sales representative in advance to determine NEC's willingness to support a given application.
- (Note)
- (1) "NEC" as used in this statement means NEC Corporation, NEC Compound Semiconductor Devices, Ltd. and also includes its majority-owned subsidiaries.
 - (2) "NEC semiconductor products" means any semiconductor product developed or manufactured by or for NEC (as defined above).

M8E 00.4-0110

SAFETY INFORMATION ON THIS PRODUCT

<p>Caution</p>	<p>GaAs Products</p>	<p>The product contains gallium arsenide, GaAs. GaAs vapor and powder are hazardous to human health if inhaled or ingested.</p> <ul style="list-style-type: none"> • Do not destroy or burn the product. • Do not cut or cleave off any part of the product. • Do not crush or chemically dissolve the product. • Do not put the product in the mouth. <p>Follow related laws and ordinances for disposal. The product should be excluded from general industrial waste or household garbage.</p>
-----------------------	----------------------	---

► **Business issue**

NEC Compound Semiconductor Devices, Ltd.

5th Sales Group, Sales Division TEL: +81-3-3798-6372 FAX: +81-3-3798-6783 E-mail: salesinfo@csd-nec.com

NEC Compound Semiconductor Devices Hong Kong Limited

Hong Kong Head Office TEL: +852-3107-7303 FAX: +852-3107-7309
 Taipei Branch Office TEL: +886-2-8712-0478 FAX: +886-2-2545-3859
 Korea Branch Office TEL: +82-2-528-0301 FAX: +82-2-528-0302

NEC Electron Devices European Operations <http://www.nec.de/>

TEL: +49-211-6503-101 FAX: +49-211-6503-487

California Eastern Laboratories, Inc. <http://www.cel.com/>

TEL: +1-408-988-3500 FAX: +1-408-988-0279

► **Technical issue**

NEC Compound Semiconductor Devices, Ltd. <http://www.csd-nec.com/>

Sales Engineering Group, Sales Division
 E-mail: techinfo@csd-nec.com FAX: +81-44-435-1918