

Attractive rugged rocker switch

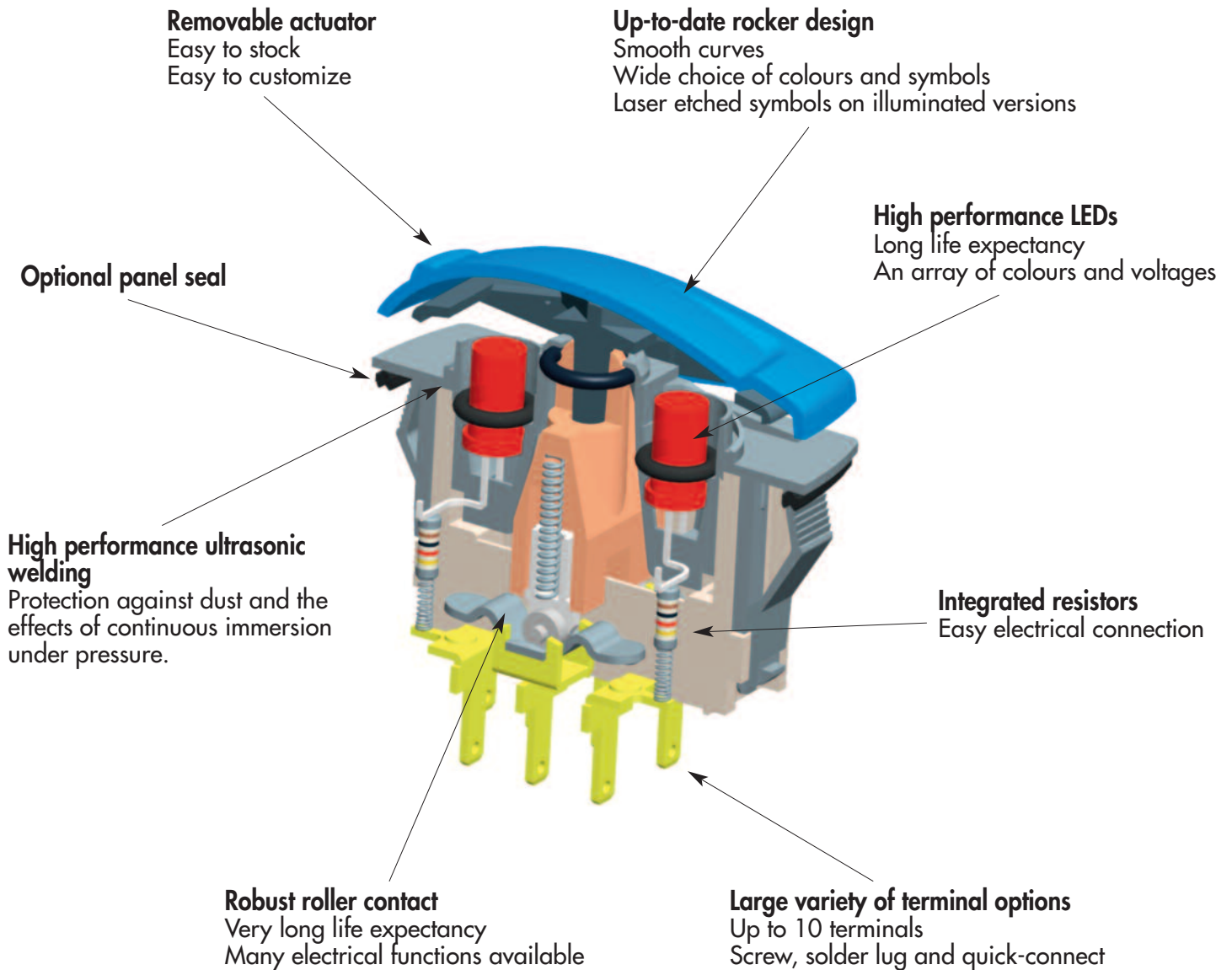

APEM will be happy to develop custom product solutions. Please contact us with your requirements.

KR series

Power rocker switches

Specifications



- Unique rocker design
- Wide choice of colours
- Laser etched symbols
- Illuminated or non-illuminated
- Optionally sealed to IP68

ELECTRICAL SPECIFICATIONS

- Current/voltage rating with resistive load :
 - Silver contacts (A) : 5A 24VDC, 100.000 cycles
 - 10A 24VDC, 10.000 cycles (terminals 6.35 x 0.8 only)
 - Gold plated contacts (D) : 20mA 12V, 150.000 cycles
- Initial contact resistance : 10 mΩ max.
- Insulation resistance : 1.000 MΩ min. at 500VDC
- Dielectric strength : 2.000 Vrms 50 Hz min. between terminals
- Mechanical life : 150.000 cycles min.

ENVIRONMENTAL SPECIFICATIONS

- Degree of protection of sealed versions : frontal sealing to IP68 according to IEC 60529 (submersion under 1 meter of water for more than 30 minutes)
- Salt spray resistance : 96 hours according to IEC 512-6, test 11f
- Vibration resistance : 10-500 Hz / 10 g per IEC 60068-2-6
- Operating temperature : -40°C to +85°C

MATERIALS

- Case : PA 6-6
- Actuator : ABS
- Bezel : PA 6-6
- Terminals : brass, silver plated
- Contacts : silver (A) or silver, gold plated (D)
- Contact roller : brass, nickel plated

SEALING

Sealing is optional.

To order a sealed product, complete the appropriate box of ordering format on the following pages.

DIMENSIONS

→ Flat seal

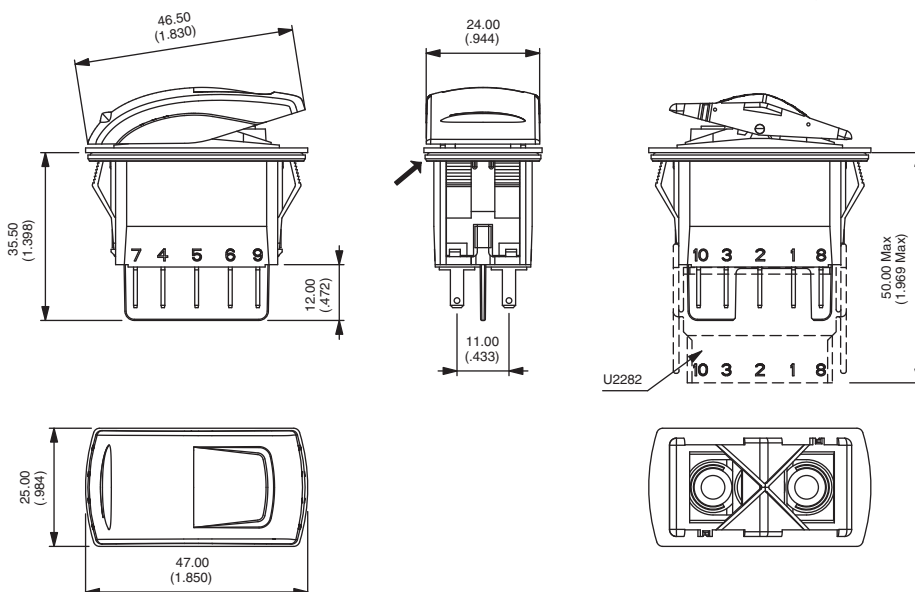

Dimensions : First dimensions are in mm while inches are shown as bracketed numbers.

Tolerance : The general tolerance for dimensions in this brochure is $\pm 0,3$ (.012). Overall dimension tolerance is $\pm 0,5$ (.020).



Packaging unit : 40 pieces

Dimensions, specifications and data shown in this brochure are subject to change without notice.

HOW TO ORDER

- To order a complete product, fill in all the boxes of the following order guide.
- To order case only (without actuator), finish your order number with the LED wiring code.
- To order actuator only (without case), begin the order number with code KRR, then follow the order format from "actuator type" until the end of the options.

CASE + LEADS

KR							Side A	Side B	
SERIES	Electrical functions			Contacts	Sealing	LEDS		Wiring	
Poles	1 ON - OFF	4 ON ON ON	4-1R ON ON MOM	A Silver	X No	X None	See diagrams page 9.		
3 Single pole	5 MOM - ON	6 ON - ON	7 MOM OFF MOM	D Gold plated	K Yes	A LED 6V red			
4 Double pole	8 ON OFF MOM	9 ON OFF ON				B LED 6V green			
				Terminals	Terminals (continued)	C LED 6V yellow			
				Screw	Quick-connect 6,35x0,8	M LED 6V blue			
				0 6 terminals with barrier	5 6 terminals w/o barrier	R LED 6V white			
				Solder lug/quick-connect	D 10 term. with barrier	D LED 12V red			
				2 6 terminals with barrier	E 10 term. w/o barrier	E LED 12V green			
				4 6 terminals w/o barrier	F 10 term. for use with connector U2292	F LED 12V yellow			
				A 10 term. with barrier	Quick-connect 2,8x0,8	N LED 12V blue			
				B 10 term. w/o barrier	G 10 term. with barrier	S LED 12V white			
				C 10 terminals for use with connector U2292	H 10 term. w/o barrier	J LED 24V red			
				Quick-connect 6,35x0,8	J 10 terminals for use with connector U2282	K LED 24V green			
				3 6 terminals with barrier		L LED 24V yellow			
						P LED 24V blue			
						T LED 24V white			

ACTUATOR

Type	Colour
1 For non-illuminated application	1 Blue
2 For illuminated application	1/4 Dark blue
	2 Black
	3 Green
	4 Grey
	5 Yellow
	6 Red
	7 Ivory
	9 Orange
	A Aluminium bright

ACTUATOR MARKING

	Area A	Area M	Area B
Orientation	Symbols		
N			
O			
S			
E			

Symbols : see page 31.
Accessories : see page 34.



NOTICE : please note that not all combinations of above numbers are available. Refer to the following pages for further information.

KR series

Power rocker switches

Case

- To order case only (without rocker), finish your order number with the LED wiring code.

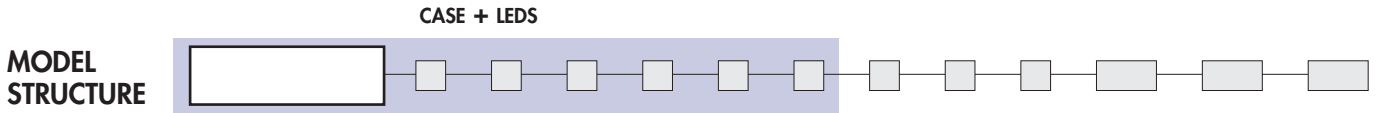



		2-3		1-2
		5-6		4-5
Single pole	Double pole			
KR31	KR41	ON	-	OFF
	KR44*	ON	ON	ON
	KR44-1R*	ON	ON	MOM
KR35	KR45	MOM	-	ON
KR36	KR46	ON	-	ON
KR37	KR47	MOM	OFF	MOM
KR38	KR48	ON	OFF	MOM
KR39	KR49	ON	OFF	ON

* Function 4 : single pole in double pole case

Bottom view

Contact area

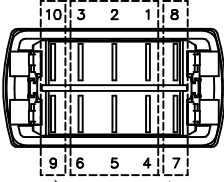

LED area

10 terminal version

Contact & LED area

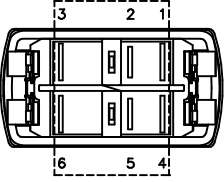







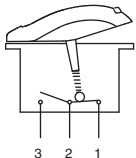
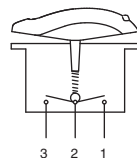
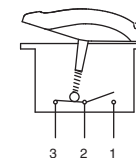
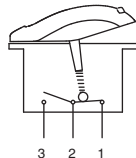
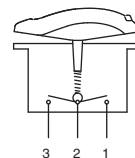
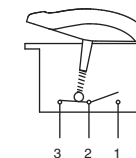
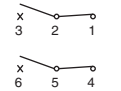

6 terminal version

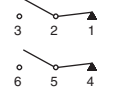
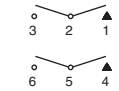
ELECTRICAL FUNCTIONS AND CONNECTIONS

In the tables below, terminal connections as viewed from bottom of switch.
Only the contact area is represented.
For single pole models, only terminals 1, 2 and 3 are to be considered (not terminals 6, 5, 4).

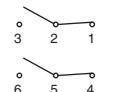
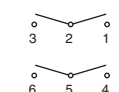
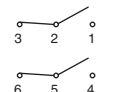
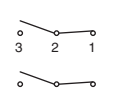
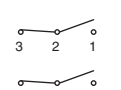
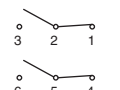
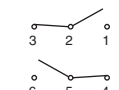
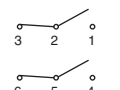
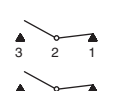
x = w/o terminal
o = with terminal
▲ = momentary

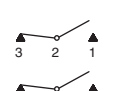
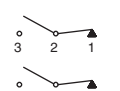
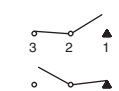
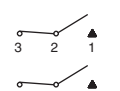
	Positions				Positions		
							
Function 1 * KR31-KR41				Function 8 KR38-KR48			
Function 5 KR35-KR45				Function 9 KR39-KR49			
Function 6 KR36-KR46				Function 4 KR44			
Function 7 KR37-KR47				Function 4-1R KR44-1R			

* Function 1 only available for 6 terminal versions.

KR series

Power rocker switches

Case

TERMINALS

CASE + LEDS

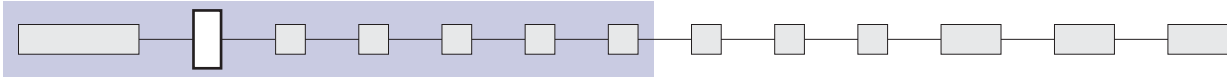

Screw

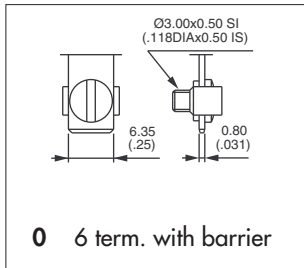

Solder lug / quick-connect

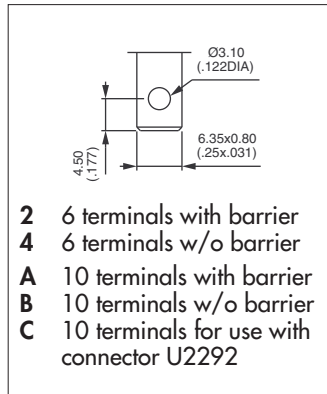

Normalized quick-connect 6,35x0,8

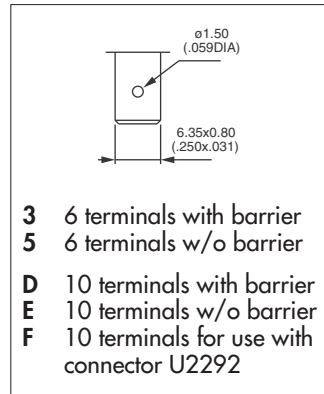

Normalized quick-connect 2,8x0,8

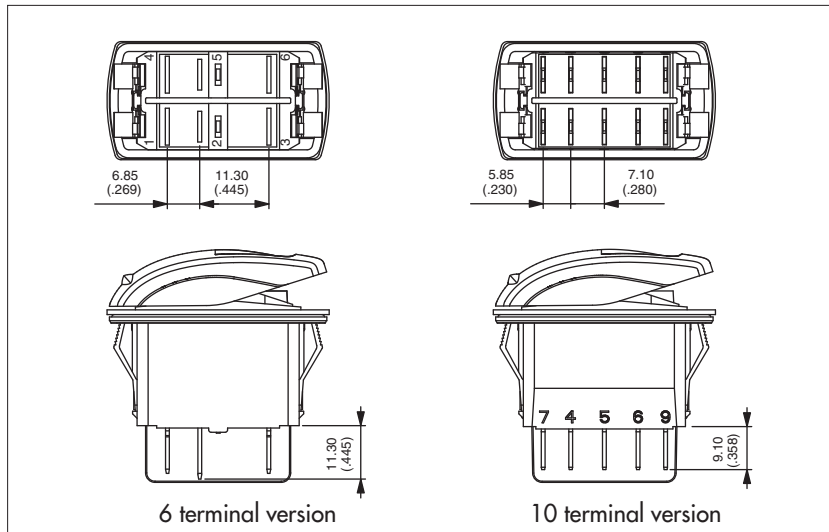
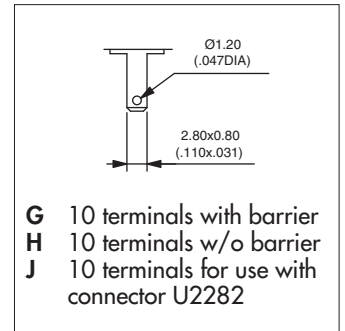

Terminals are marked on the case.

The drawings show the maximum possible number of terminals.

CONTACT MATERIALS

CASE + LEDS

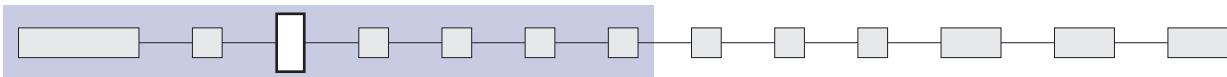

- A** Silver
- D** Silver, gold plated

KR series

Power rocker switches

Case - LEDs

SEALING

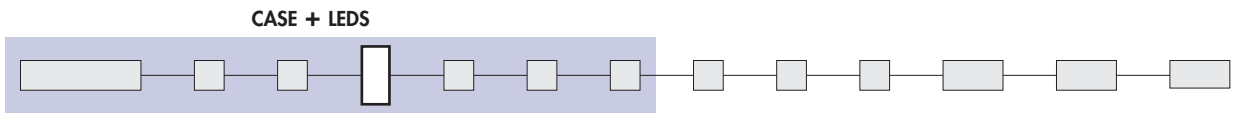

X No sealing

K IP68 (switch assembled on panel)

Ultrasonic welding of frame to case is standard on all versions.
The ultrasonic welding and the optional panel seal prevent water and dust from introducing into the switch housing.

*The product shall be installed professionally.
Test conditions available on request.*

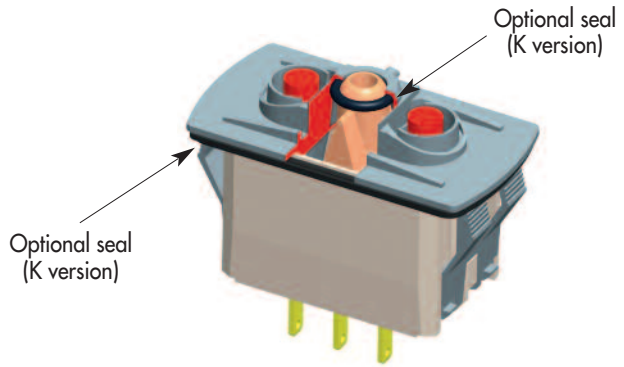

LEDS

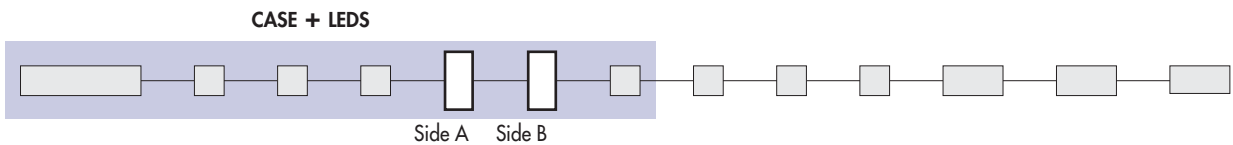

Complete each enlarged box with one of the codes listed below.

X Without LED

	Red	Green	Yellow	Blue	White
6VDC	A	B	C	M	R
12VDC	D	E	F	N	S
24VDC	J	K	L	P	T

LED consumption : 20mA @ nominal voltage (25°C)

Other illumination solutions : on request.

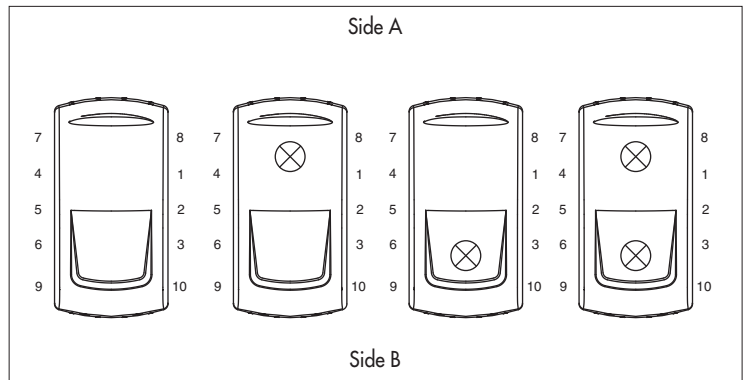

WIRING

The LED wiring diagram is shown on the case.

CASE + LEDs

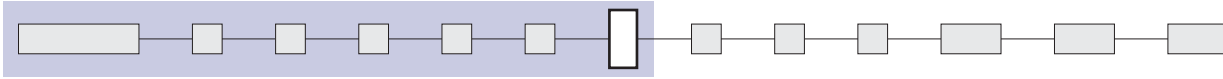

• For 6 terminal versions

LED connected to the load

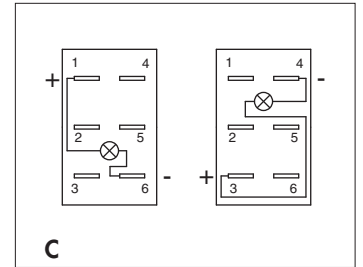
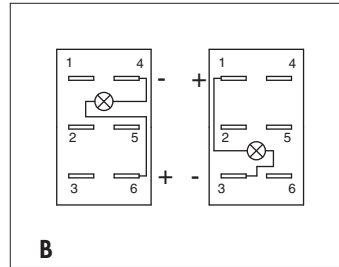
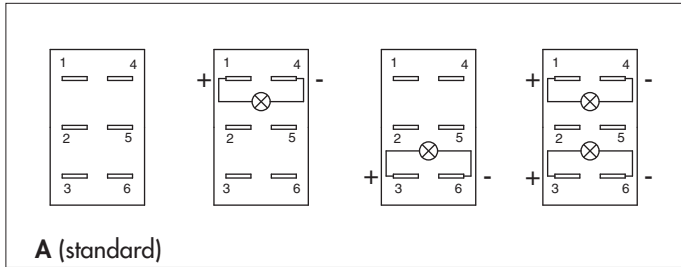

Note : If not available, terminals are added to connect the LED.

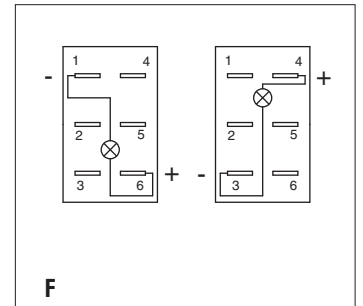
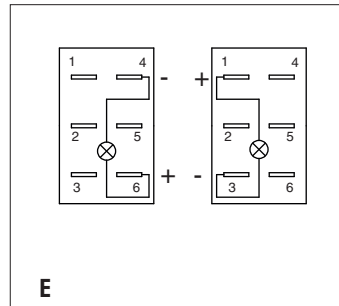
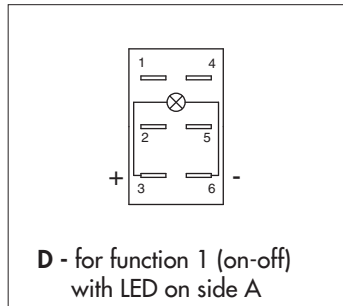

• For 10 terminal versions

Independent LED or integrated functions

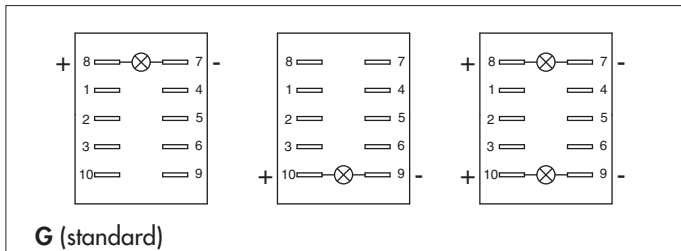

To have independent LEDs.

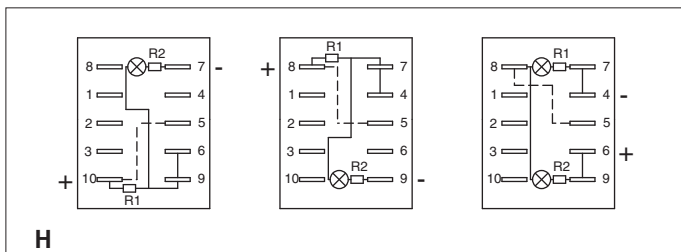

Available in Single Pole only, with H and J quick-connect terminals.

To obtain 2 symbol illumination levels (night illumination when OFF and higher illumination when ON).

Dotted line = external wiring, continuous line = internal wiring

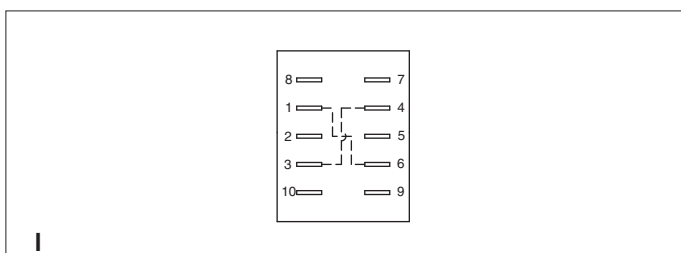

To have a polarity inversion (typical application : fan motor).

Dotted line = internal wiring, continuous line = internal wiring

Power supply between 2 and 5 - Load between 1 and 4 or 3 and 6. Available with H and J quick-connect terminals.

Please contact us for other wiring solutions.

KR series

Power rocker switches

Actuator - Marking

To order actuator only (without case), begin the order number with code KRR, then follow the order format from "actuator type" until the end of the options.

ACTUATOR TYPE

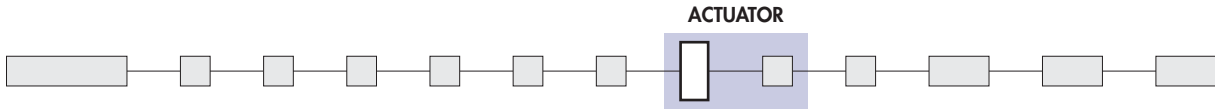

- 1 For non-illuminated application
 - 2 For illuminated application
- Other rocker design : on request.

ACTUATOR COLOUR

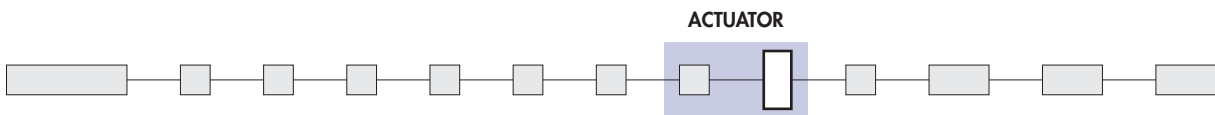

Code	Colour
1	Blue
1/4	Dark blue
2	Black
3	Green

Code	Colour
4	Grey
5	Yellow
6	Red
7	Ivory

Code	Colour
9	Orange
A	Aluminium bright

Note : colour 7 not available on illuminated versions.

A **soft-touch varnish** can be added. Consult us.



MARKING ORIENTATION

If no marking required, leave box blank.

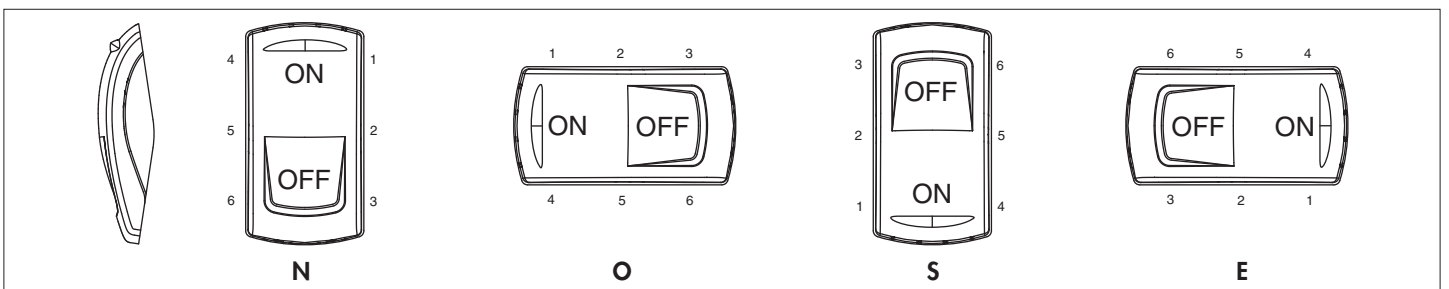
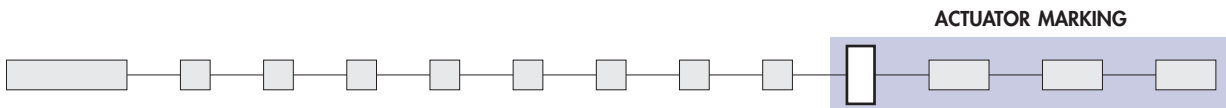

Other orientations : on request

SYMBOLS

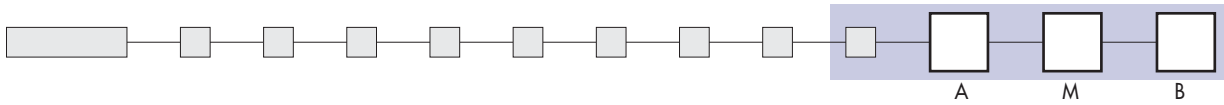

Available symbols : see page 31.

Marking colour

White marking for illuminated rockers (laser etching) and non-illuminated black rockers (pad printing). Black marking for non-illuminated colour rockers (pad printing). Other : on request.

Laser etching resistance

- Water and petrol resistant according to EN61058-1
- Tear resistant (cross-cut test) according to NF ISO 2409 : class 0
- UV resistant according to ISO 4892-2

Marking area

For illuminated versions. The symbol will be included in the hatched area.

Marking in M are : on request.

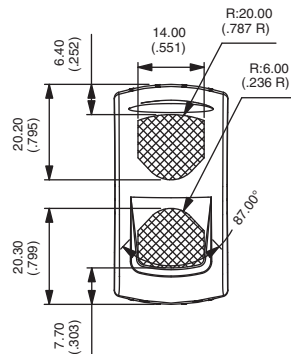
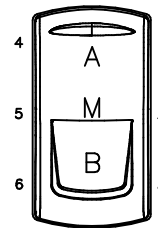

SWITCH PANEL CUT-OUT

Panel thickness : 0,8 mm to 4,6 mm
Recommended panel thickness :
between 2 mm and 3,5 mm

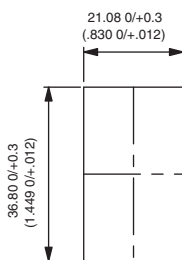

MATRIX MOUNTING

