



Raychem

TE Internal #: 282071-000

Hook Up Wire, Spec 44, 600V Voltage Rating, White Wire Color, 20AWG Wire Size, Operating Temperature Range -65 – 150 °C

[View on TE.com >](#)

Wire & Cable > Hook Up Wire



Cable Type: **Spec 44**

Voltage Rating: **600 V**

Wire Color: **White**

Insulation Material: **Modified Radiation Cross-linked PVDF**

Conductor Material: **Silver-Coated Copper**

## Features

### Product Type Features

|            |         |
|------------|---------|
| Cable Type | Spec 44 |
|------------|---------|

### Electrical Characteristics

|                |       |
|----------------|-------|
| Voltage Rating | 600 V |
|----------------|-------|

### Body Features

|                     |                                      |
|---------------------|--------------------------------------|
| Wire Color          | White                                |
| Insulation Material | Modified Radiation Cross-linked PVDF |
| Conductor Material  | Silver-Coated Copper                 |

### Dimensions

|           |        |
|-----------|--------|
| Wire Size | 20 AWG |
|-----------|--------|

### Usage Conditions

|                             |              |
|-----------------------------|--------------|
| Operating Temperature Range | -65 – 150 °C |
|-----------------------------|--------------|

## Product Compliance

[For compliance documentation, visit the product page on TE.com>](#)

|   |   |
|---|---|
| EU RoHS Directive 2011/65/EU                  | Compliant                               |
| EU ELV Directive 2000/53/EC                   | Compliant                               |
| China RoHS 2 Directive MIIT Order No 32, 2016 | No Restricted Materials Above Threshold |
| EU REACH Regulation (EC) No. 1907/2006        |   |



Current ECHA Candidate List: JUN 2020  
(209)  
Candidate List Declared Against: JUL 2019  
(201)  
Does not contain REACH SVHC

Halogen Content  
Out of Scope - excluded from Halogen requirements

Solder Process Capability  
Not applicable for solder process capability

Product Compliance Disclaimer

This information is provided based on reasonable inquiry of our suppliers and represents our current actual knowledge based on the information they provided. This information is subject to change. The part numbers that TE has identified as EU RoHS compliant have a maximum concentration of 0.1% by weight in homogenous materials for lead, hexavalent chromium, mercury, PBB, PBDE, DBP, BBP, DEHP, DIBP, and 0.01% for cadmium, or qualify for an exemption to these limits as defined in the Annexes of Directive 2011/65/EU (RoHS2). Finished electrical and electronic equipment products will be CE marked as required by Directive 2011/65/EU. Components may not be CE marked. Additionally, the part numbers that TE has identified as EU ELV compliant have a maximum concentration of 0.1% by weight in homogenous materials for lead, hexavalent chromium, and mercury, and 0.01% for cadmium, or qualify for an exemption to these limits as defined in the Annexes of Directive 2000/53/EC (ELV). Regarding the REACH Regulations, TE's information on SVHC in articles for this part number is still based on the European Chemical Agency (ECHA) 'Guidance on requirements for substances in articles' (Version: 2, April 2011), applying the 0.1% weight on weight concentration threshold at the finished product level. TE is aware of the European Court of Justice ruling of September 10th, 2015 also known as O5A (Once An Article Always An Article) stating that, in case of 'complex object', the threshold for a SVHC must be applied to both the product as a whole and simultaneously to each of the articles forming part of its composition. TE has evaluated this ruling based on the new ECHA "Guidance on requirements for substances in articles" (June 2017, version 4.0) and will be updating its statements accordingly.

### Compatible Parts



TE Model / Part # A36675-000  
D-200-83

### Customers Also Bought



TE Model / Part #4-1879075-7  
Power Resistor: Aluminum Housed, 75 Watt



TE Model / Part #34113-4  
SOLIS R HR 22-16 1/4 NIPL



TE Model / Part #2335891-3  
AMPLIMITE SZ 3 PLUG 44 POS, ST STL SHEL



TE Model / Part #2335893-3  
AMPLIMITE SZ 3 RECPT 44 POS, ST STL SHEL



TE Model / Part #206798-1  
PLUG ASSY,15 POSN,AMPLMTE

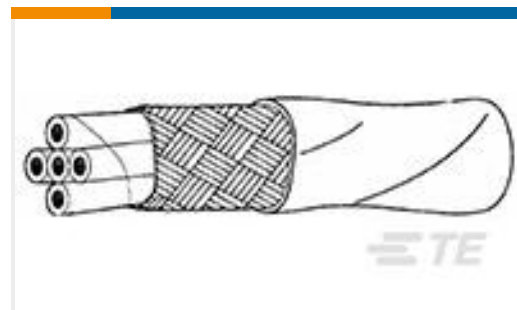

TE Model / Part #4805483001  
55A1151-24-0/2/4/5/6-9



TE Model / Part #3163083001  
55A1121-28-0/9-9

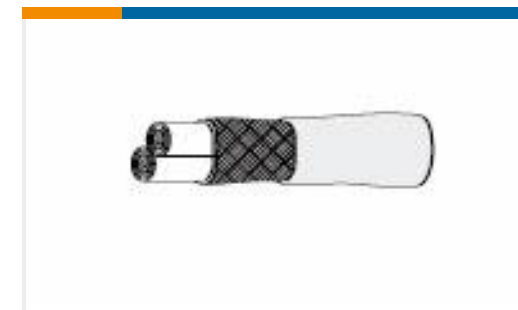

TE Model / Part #8437253001  
55A1141-26-0/2/6/9-9

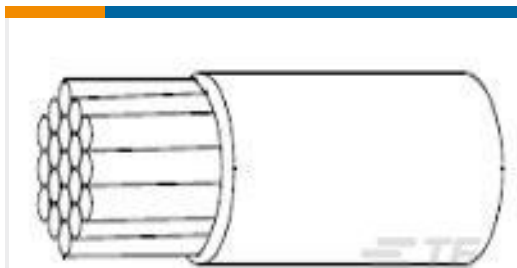

TE Model / Part #368960-000  
55A0112-24-0

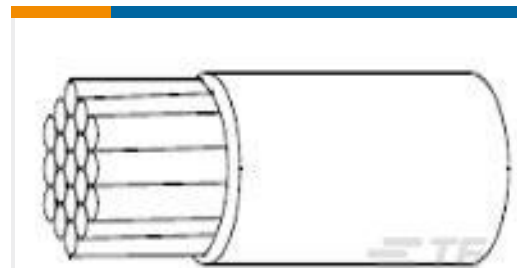

TE Model / Part #4357003001  
55/9952-22-5(LAT3)

## Documents

### Product Drawings

[44A0112-20-9](#)

English

### Datasheets & Catalog Pages

[1654025\\_Sec9\\_SPEC44](#)

English

[Raychem Wire and Cable Quick Reference Guide](#)

English

### Product Specifications

[Product Specification](#)

English