

#### **GENERAL DESCRIPTION**

The MSM6950B is an analog front-end LSI which is fabricated by OKI's low power consumption CMOS silicon gate technology for modem chip set based on Bell 212A, CCITT V. 22 and CCITT V. 22 bis standard. The MSM6950B consists of two BPFs, for low band and high band, an A/D converter with 8-bit parallel output, a D/A converter with 8-bit parallel input, an AGC circuit controlled by external digital signals, a guard tone generator (550 Hz/1800 Hz selectable) and some analogue signal control switches for various applications.

The MSM6950B communicates with a modulator and a demodulator via each 8 bit parallel digital line.

This chip does not contain a carrier detect function but this function can be performed with a digital signal processor dedicated as a demodulator by using digital signals from the A/D converter.

#### **FEATURES**

- Conforms to Bell 212A, 103 and CCITT V. 22 and V. 22 bis.
- 8-bit parallel output A/D converter and 8-bit parallel input D/A converter provided on chip.
- On-chip voltage reference.
- On-chip AGC circuit controlled by 8-bit external digital signal, over the received signal level range of 48 dB in 0.19 dB steps.
- Dynamic range, 70 dB.
- Guard tone mixing function, 550 Hz or 1800 Hz.
- On-chip multi-purpose LPF for tone transmitting and call progress detection.
- Provides internal analog loop back function.
- Supply voltage,  $\pm 5V$ .
- Low power dissipation, 115 mW.
- 3.6864 MHz external clock for operation.
- 42 pin plastic DIP (DIP42-P-600)
- 56 pin(L)-V plastic QFP (QFP56-P-1519-VK)
- 44 pin plastic QFJ (PLCC) (QFJ44-P-S650)

**PIN CONFIGURATION (Top view)**

**42 pin DIP (MSM6950BRS)**

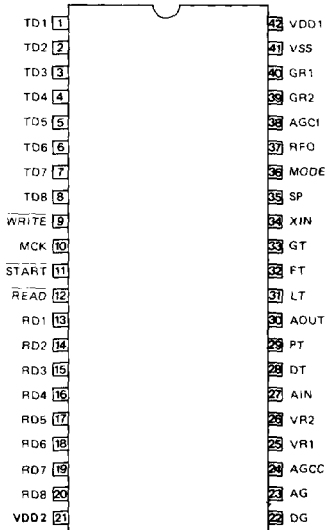

**44 pin PLCC (MSM6950BJS)**

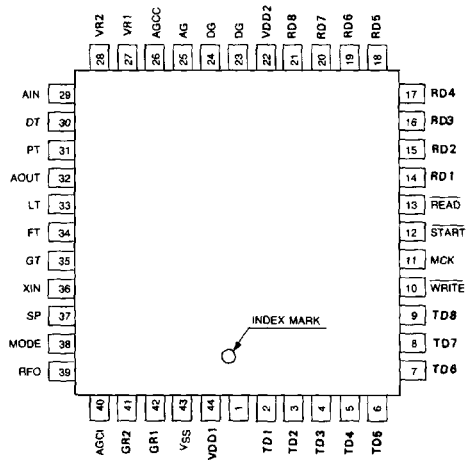

**56 pin FLAT (MSM6950BGS-VK)**

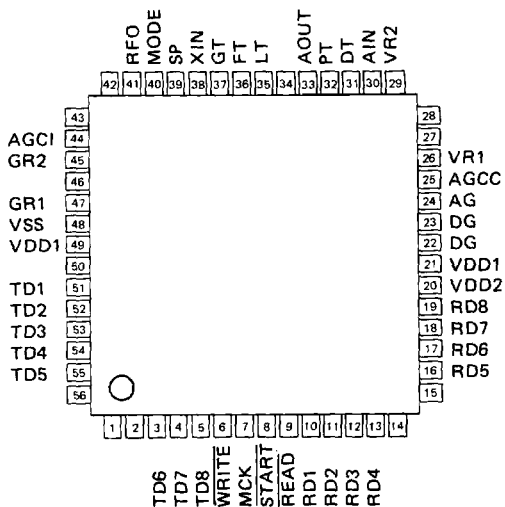



## Pin Assignment

Pin Name	Pin No.			In/Out	Function
	RS	GS	JS		
TD1	1	51	2	Input	Transmit signal digital data input to DA (LSB)
TD2	2	52	3	Input	Transmit signal digital data input to DA
TD3	3	53	4	Input	Transmit signal digital data input to DA
TD4	4	54	5	Input	Transmit signal digital data input to DA
TD5	5	55	6	Input	Transmit signal digital data input to DA
TD6	6	3	7	Input	Transmit signal digital data input to DA
TD7	7	4	8	Input	Transmit signal digital data input to DA
TD8	8	5	9	Input	Transmit signal digital data input to DA (MSB)
WRITE	9	6	10	Input	TD writing control signal for DA
MCK	10	7	11	Input	Master clock input 3.6864 MHz
START	11	8	12	Input	Control signal for starting of AD conversion
READ	12	9	13	Input	RD reading control signal for AD
RD1	13	10	14	In/Out	Receive signal digital data output from AD (LSB)
RD2	14	11	15	In/Out	Receive signal digital data output from AD
RD3	15	12	16	In/Out	Receive signal digital data output from AD
RD4	16	13	17	In/Out	Receive signal digital data output from AD
RD5	17	16	18	In/Out	Receive signal digital data output from AD
RD6	18	17	19	In/Out	Receive signal digital data output from AD
RD7	19	18	20	In/Out	Receive signal digital data output from AD
RD8	20	19	21	In/Out	Receive signal digital data output from AD (MSB)
VDD2	21	20	22		Positive power supply (+5 V)
DG	22	22, 23	23, 24		Digital ground (0 V)
AG	23	24	25		Analog ground (0 V)
AGCC	24	25	26		External capacitor terminal for AGC
VR1	25	26	27	Input	External resistor terminal for reference voltage
VR2	26	29	28	Output	External resistor terminal for reference voltage
A1N	27	30	29	Input	Receive analog signal input
DT	28	31	30	Input	Dial tone detecting loop
PT	29	32	31	Input	DTMF signal transmitting loop
AOUT	30	33	32	Output	Transmit analog signal output
LT	31	35	33	Input	AC loop test
FT	32	36	34	Input	XIN enable (Filter test or External input)
GT	33	37	35	Input	Guard tone select (1800/550 Hz)
XIN	34	38	36	Input	External transmit analog signal input
SP	35	39	37	Input	DA output PAM width select
MODE	36	40	38	Input	Originate/Answer mode select
RFO	37	41	39	Output	Receive filter output
AGCI	38	44	40	Input	AGC circuit input
GR2	39	45	41	Output	External resistor terminal for Guard tone level
GR1	40	47	42	Input	External resistor terminal for Guard tone level
VSS	41	48	43		Negative power supply (-5 V)
VDD1	42	21,49	44		Positive power supply (+5 V)

## ELECTRICAL CHARACTERISTICS

## 1. Absolute Maximum Ratings

Parameter	Symbol	Conditions	Ratings	Unit
Supply voltage	VDD	Ta = 25°C with respect to AG or DG	-0.3 ~ +7	V
	VSS		+0.3 ~ -7	
Analog input voltage	VIA		VSS - 0.3 ~ VDD + 0.3	
Digital input voltage	VID		-0.3 ~ VDD + 0.3	
Operating temperature	T <sub>OP</sub>	—	-40 ~ + 85	°C
Storage temperature	T <sub>STG</sub>	—	-55 ~ +150	

## 2. Recommended Operating Conditions

Parameter	Symbol	Condition	Min	Typ	Max	Unit	
Power Supply Voltage	V <sub>DD</sub>	With Respect to AG or DG	4.75	5.00	5.25	V	
	V <sub>SS</sub>		-5.25	-5.00	-4.75		
	AG, DG		-	0	-		
Operating temperature	T <sub>OP</sub>	-	0	-	70	°C	
R <sub>0</sub>	-	-	-	51	-	kΩ	
R <sub>1</sub>	-	Transformer Impedance (Hybrid) [600 Ω] [600 Ω]: 600 Ω	-	600	-	Ω	
R <sub>2</sub>	-		-	600	-		
R <sub>3</sub>	-		-	300	-		
R <sub>4</sub>	-	-	-	51	-	kΩ	
R <sub>5</sub>	-		-	51	-		
R <sub>6</sub>	-		-	51	-		
R <sub>7</sub>	-		-	51	-		
R <sub>8</sub>	-		-	10	33		-
R <sub>9</sub>	-		-	-	36		-
R <sub>10</sub>	-		-	-	100		-
R <sub>11</sub>	-		-	-	51		-
R <sub>12</sub>	-		-	-	51		-
C <sub>0</sub>	-		-	-	0.1		-
C <sub>1</sub>	-	-		2.2	-		
C <sub>2</sub>	-	-		1	-		
C <sub>3</sub>	-	-		0.1	-		
C <sub>4</sub>	-	-		1	-		
C <sub>5</sub> , C <sub>7</sub> , C <sub>9</sub>	-	-		-	10	-	
C <sub>6</sub> , C <sub>8</sub>	-	-		-	1	-	
R <sub>13</sub> ~ R <sub>20</sub>	-	-	-	20	-	kΩ	
Reference Voltage	V <sub>R</sub>	Adjusted by External Resistors	-	+2.50	-	V	
Master Clock Frequency	F <sub>MCK</sub>	-	3.6860	3.6864	3.6867	MHz	
MCK Duty Cycle	DMCK	50% to 50%	30	50	70	%	
Digital Input Rise Time	T <sub>R</sub>	T <sub>D1</sub> ~ T <sub>D8</sub> , WRITE, START, READ, R <sub>D1</sub> ~ R <sub>D8</sub> , See Figure 1	0	-	50	nS	
Digital Input Fall Time	T <sub>F</sub>		0	-	50	nS	

◆ MODEM · MSM6950B ◆

Parameter	Symbol	Condition	Min	Typ	Max	Unit
WRITE Period	TPW	See Figure 2, 3	115	1/ 0.0072	143	μs
WRITE Width	TWW		0.55	—	100	μs
START Period	TPS		98.2	1/ 0.0072	143	μs
START Width	TWS		1.1	—	79	μs
READ Width	TWR		3.2	—	*	μs
START → READ Timing	TSR		80	—	*	μs
READ → START Timing	TRS		15	—	*	μs
Allowable XIN Input DC Offset Voltage	VOSXIN	—	-100	—	+100	mV
Allowable AIN Input DC Offset Voltage	VOSAIN	—	-100	—	+100	mV

\* TWR MAX = TPS - TSR - TRS

TSR MAX = TPS - TWR - TRS

TRS MAX = TPS - TWR - TSR

### 3. Power Dissipation

(V<sub>DD</sub> = +5 V ±5%, V<sub>SS</sub> = -5 V ±5%, V<sub>R</sub> = +2.5 V, T<sub>a</sub> = 0 ~ 70°C)

Parameter	Symbol	Condition	Min	Typ	Max	Unit
Positive Power Supply Current	I <sub>DD</sub>	—	—	12	20	mA
Negative Power Supply Current	I <sub>SS</sub>	—	—	11	20	mA

Note: I<sub>DD</sub> = I<sub>DD1</sub> (V<sub>DD1</sub> pin) + I<sub>DD2</sub> (V<sub>DD2</sub> pin).

## 4. Digital Interface

(V<sub>DD</sub> = +5 V ±5%, V<sub>SS</sub> = -5 V ±5%, T<sub>a</sub> = 0 ~ 70°C)

Parameter	Symbol	Condition	Min	Typ	Max	Unit
Input Low Voltage	V <sub>IL</sub>	—	—	—	0.6	V
Input High Voltage	V <sub>IH</sub>	—	2.2	—	—	V
Output Low Voltage	V <sub>OL</sub>	I <sub>OL</sub> = 0.36 mA	—	—	0.4	V
Output High Voltage	V <sub>OH</sub>	I <sub>OH</sub> = 20 μA	2.4	—	—	V
Input Low Current	I <sub>IL</sub>	DG ≤ V <sub>IN</sub> ≤ V <sub>IL</sub>	-10	—	10	μA
Input High Current	I <sub>IH</sub>	V <sub>IH</sub> ≤ V <sub>IN</sub> ≤ V <sub>DD</sub>	-10	—	10	μA
DA Data Set-up Time	T <sub>SD</sub>	See Figure 3	0	—	—	μs
DA Data Hold Time	T <sub>HD</sub>		1.1	—	—	μs
AGC Data Set-up Time	T <sub>SA</sub>	See Figure 2	0	—	—	μs
AGC Data Hold Time	T <sub>HA</sub>		2.2	—	—	μs
AD Data Output Delay Time	T <sub>D1</sub>	Pull-up Resistor = 20 KΩ See Figure 2	0.4	—	3	μs
	T <sub>D2</sub>		0.5	—	3	μs

## 5. ANALOG INTERFACE (VDD = +5V ± 5%, -5V ± 5%, Ta = 0~70°C)

## Reference Voltage (VR2)

Parameter	Symbol	Condition	Min	Typ	Max	Unit
Reference Voltage	VR	R8 = Opened	1.03	1.16	1.30	V

## Transmit Modem Signal Characteristics (XIN, AOUT)

Parameter	Symbol	Condition	Min	Typ	Max	Unit		
Input Resistance	RXIN	XIN $f_{XIN} \leq 5\text{KHz}$	500			k $\Omega$		
Input Voltage	VXIN	XIN			5	V <sub>PP</sub>		
Output Voltage	VAOUT	RAOUT $\geq 20\text{K}\Omega$ , CAOUT $\leq 100\text{PF}$	5			V <sub>PP</sub>		
Load Resistance	RAOUT		20			k $\Omega$		
Load Capacitance	CAOUT				100	PF		
DC Offset Voltage	VOST	AOUT, XIN = 0V	- 500	0	+ 500	mV		
*1 Absolute Voltage Gain	Bell 212A/ V.22/V.22bis	GT1	Originate	1200Hz, 0dBm	+ 0.5	+ 2.0	+ 3.5	dB
		GT2	Answer	2400Hz, 0dBm	+ 0.5	+ 2.0	+ 3.5	dB
	Tone Transmit	GT3	GT = 1, 1020Hz, 0dBm	+ 0.5	+ 2.0	+ 3.5	dB	
Gain Tracking	TGT1	GT1 - GT2	- 1.0	0	+ 1.0	dB		
*2 Idle Channel Noise	Bell 212A/ V.22/V.22bis	NIDLT1	Originate	0.3~ 3.4KHz		- 60/ - 55	- 55/ - 50	dBm
		NIDLT2	Answer			- 56/ - 50	- 50/ - 45	dBm
		NIDLT3	Originate	1.8~ 3KHz		- 76/ - 74	- 65/ - 65	dBm
		NIDLT4	Answer	0.6~ 1.8KHz		- 73/ - 71	- 65/ - 65	dBm
	Tone Transmit	NIDLT5	GT = 1	0.3~ 3.4KHz		- 71/ - 70	- 60/ - 60	dBm

Parameter	Symbol	Condition	Min	Typ	Max	Unit	
Clock Noise	NCLKT	All modes, at 57.6KHz			- 50	dBm	
Total Harmonic Distortion	Bell 212A/ V.22/V.22bis	THDT1	Originate	1200Hz, 0dBm	- 55	- 50	dB
		THDT2	Answer	2400Hz, 0dBm	- 48	- 43	dB
	Tone Transmit	THDT3	GT = 1, 1020Hz, 0dBm		- 60	- 55	dB

\*1 GT = 20 log (VAOUT/VXIN)

\*2 Idle Channel Noise is defined with no weighted filter.

① / ②    ①; WRITE = 7.2KHz, ②; WRITE = 8.4KHz

Note) 0dBm = 0.775Vrms

### Guard Tone (AOUT)

Parameter	Symbol	Condition	Min	Typ	Max	Unit
Tone Frequency	FGT1	GT = 0	530	553.8	570	Hz
	FGT2	GT = 1	1780	1800	1820	Hz
Tone Amplitude	VGT1	GT = 0, R11 = Opened	- 13.5	- 15.0	- 16.5	dBm
	VGT2	GT = 1, R11 = Opened	- 13.0	- 14.5	- 16.0	dBm
Total Harmonic Distortion (2nd and 3rd) *	THDGT1	GT = 0, VGT1 = - 4dBm		- 63	- 57	dB
	THDGT2	GT = 1, VGT2 = - 4dBm		- 51	- 45	dB

\* Harmonics above 3rd harmonic are negligible.

Receive Modem Signal Characteristics (AIN, RFO)

Parameter		Symbol	Condition		Min	Typ	Max	Unit
Input Resistance		RAIN	AIN $f_{XIN} \leq 5\text{KHz}$		500			k $\Omega$
Input Voltage Swing		VAIN	AIN				5	V <sub>PP</sub>
Output Voltage		VRFO	RRFO $\geq 20\text{K}\Omega$ , CRFO $\leq 100\text{PF}$		5			V <sub>PP</sub>
Load Resistance		RRFO	RFO		20			K $\Omega$
Load Capacitance		CRFO	RFO				100	PF
DC Offset Voltage		VOSR	RFO		- 500	0	+ 500	mV
*1 Absolute Voltage Gain	Bell 212A/ V.22/V.22bis	GR1	Answer	1200Hz, 3dBm	- 1.5	0	+ 1.5	dB
		GR2	Originate	2400Hz, 3dBm	- 1.5	0	+ 1.5	dB
	Tone Receive		GR3	GT = 0, 300Hz, 3dBm		- 1.5	0	+ 1.5
Gain Tracking		TGR	GR1-GR2		- 1.0	0	+ 1.0	dB
*2 Idle Channel Noise	Bell 212A/ V.22/V.22bis	NIDLR1	Answer	0.3~ 3.4KHz		- 63/ - 60	- 57/ - 55	dBm
		NIDLR2	Originate			- 63/ - 60	- 57/ - 55	dBm
	Tone Receive		NIDLR3		GT = 0		- 75/ - 73	- 60/ - 60
Clock Noise		NCLKR1	All modes, at 57.6KHz				- 45	dBm
		NCLKR2	GT = 0, at N x 14.4KHz				- 35	dBm
Total Harmonic Distor- tion	Bell 212A/ V.22/V.22bis	THDR1	Answer	1200Hz, + 3dBm		- 47	- 43	dB
		THDR2	Originate	2400Hz, + 3dBm		- 41	- 37	dB
		THDR3	Originate	1200Hz, 0dBm		- 58	- 53	dB
	Tone Receive		THDR4	GT = 0, 300Hz, + 3dBm			- 53	- 49

\*1 GR = 20 log (VRFO/VAIN)

\*2 Idle Channel Noise is defined with no weighted filter.

① / ② ①;WRITE = 7.2KHz, ②; WRITE = 8.4KHz

## 6. Filter Transfer Characteristics

## Low-band BPF

 $(V_{DD} = +5\text{ V} \pm 5\%, V_{SS} = -5\text{ V} \pm 5\%, V_R = +2.5\text{ V}, T_a = 0 \sim 70^\circ\text{C})$ 

Relative Voltage Gain to $G_{FL4}$	$G_{FL1}$	508 Hz	—	-44	-40	dB
	$G_{FL2}$	555 Hz	—	-60	-45	dB
	$G_{FL3}$	898 Hz	-1.5	—	+1.5	dB
	$G_{FL4}$	1,008 Hz	Referred Gain 0			dB
	$G_{FL5}$	1,148 Hz	-1.5	—	+1.5	dB
	$G_{FL6}$	1,352 Hz	-1.5	—	+1.5	dB
	$G_{FL7}$	1,508 Hz	-2	—	+1	dB
	$G_{FL8}$	1,805 Hz	—	-65	-45	dB
	$G_{FL9}$	2400 Hz	—	-55	-50	dB
Group Delay Distortion	$G_{DL}$	900 ~ 1,500 Hz	—	—	100	$\mu\text{s}$

◆ MODEM · MSM6950B ◆

High-band BPF

Parameter	Symbol	Condition	Min	Typ	Max	Unit
Relative Voltage Gain to GFH <sub>4</sub>	GFH <sub>1</sub>	1,195 Hz	—	-55	-50	dB
	GFH <sub>2</sub>	1,641 Hz	—	-55	-50	dB
	GFH <sub>3</sub>	2,055 Hz	-1.5	—	+1.5	dB
	GFH <sub>4</sub>	2,195 Hz	Referred Gain 0			dB
	GFH <sub>5</sub>	2,398 Hz	-1.5	—	+1.5	dB
	GFH <sub>6</sub>	2,602 Hz	-1.5	—	+1.5	dB
	GFH <sub>7</sub>	2,742 Hz	-0.5	—	+2.5	dB
	GFH <sub>8</sub>	3,211 Hz	—	-43	-38	dB
	GFH <sub>9</sub>	3,398 Hz	—	-35	-29	dB
Group Delay Distortion	GDH	2,100 ~ 2,700 Hz	—	—	200	μs

Multi-purpose LPF

Parameter	Symbol	Condition	Min	Typ	Max	Unit	
Relative Voltage Gain to GFLF <sub>2</sub>	GFLF <sub>1</sub>	211 Hz	GT = 0	-1	0	+1	dB
	GFLF <sub>2</sub>	305 Hz		Referred Gain 0			dB
	GFLF <sub>3</sub>	727 Hz		-4	-3	-2	dB
	GFLF <sub>4</sub>	1,508 Hz		—	—	-30	dB
Relative Voltage Gain to GFHF <sub>2</sub>	GFHF <sub>1</sub>	211 Hz	GT = 1	-1	0	+1	dB
	GFHF <sub>2</sub>	305 Hz		Referred Gain 0			dB
	GFHF <sub>3</sub>	2,906 Hz		-4	-3	-2	dB
	GFHF <sub>4</sub>	3,898 Hz		—	—	-10	dB

**7. AGC Circuit and DA, AD Converters** $(V_{DD} = +5\text{ V} \pm 5\%, V_{SS} = -5\text{ V} \pm 5\%, V_R = +2.5\text{ V}, T_a = 0 \sim 70^\circ\text{C})$ 

Parameter	Symbol	Condition	Min	Typ	Max	Unit
-----------	--------	-----------	-----	-----	-----	------

**AGC Amplifier**

Input Resistance	$R_{AGCI}$	—	—	1	—	$M\Omega$
Variable Voltage Gain Range	$G_{AGC}$	—	-4	—	+43.8	dB
Voltage Gain Accuracy	$G_E$	—	-0.4	+0.03 ~-0.17	+0.4	dB
Output DC Offset Voltage	$V_{OSAGC}$	AGC1 = 0 V	-60 (-3)	—	+60 (+3)	mV (LSB)

**Transmit Digital to Analog Converter**

Bits of Resolution	$B_{REST}$	—	—	8	—	bit
End-point Linearity	$NL_{DA}$	—	—	0.36	0.5	%
Differential Non-linearity	$DNL_{DA}$	—	—	1/5	1/2	LSB
Full Scale	Plus Full Scale	$PFV_{DA}$	—	—	+2,481	mV
	Minus Full Scale	$NFV_{DA}$	—	—	-2,500	mV
DC Offset Voltage	$V_{OSDA}$	—	-10	-1.5	+10	mV

**Receive Analog to Digital Converter**

Bits of Resolution	$B_{RESR}$	—	—	8	—	bit
End-point Linearity	$NL_{AD}$	—	—	0.24	0.5	%
Differential Non-linearity	$DNL_{AD}$	—	—	1/5	1/2	LSB
Full Scale	Plus Full Scale	$PFV_{AD}$	—	—	+2,481	mV
	Minus Full Scale	$NFV_{AD}$	—	—	-2,500	mV
DC Offset Voltage*	$V_{OSAD}$	—	-1/2	—	+1/2	LSB

\* This specification does not include the DC offset voltage at the input of the AD converter.

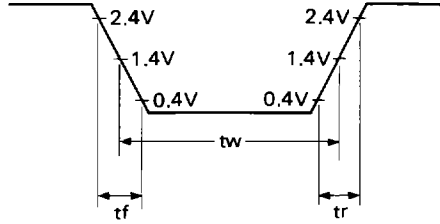

Figure 1 Definition of Rise/Fall Time

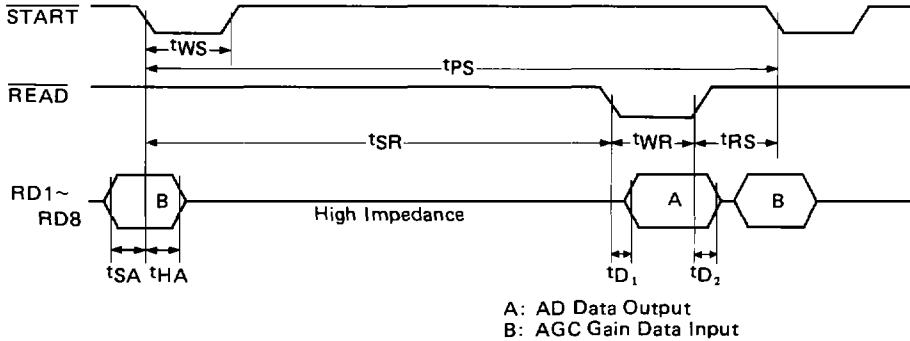

Figure 2 Receive Data Timing Chart

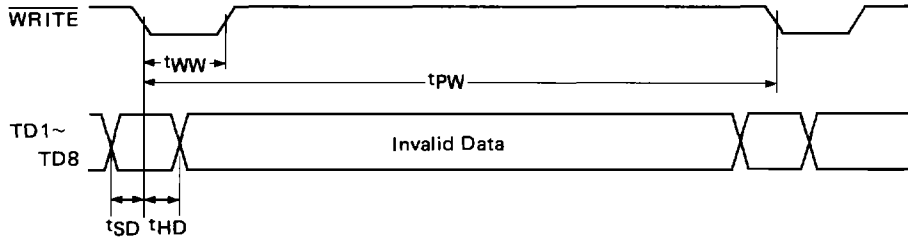
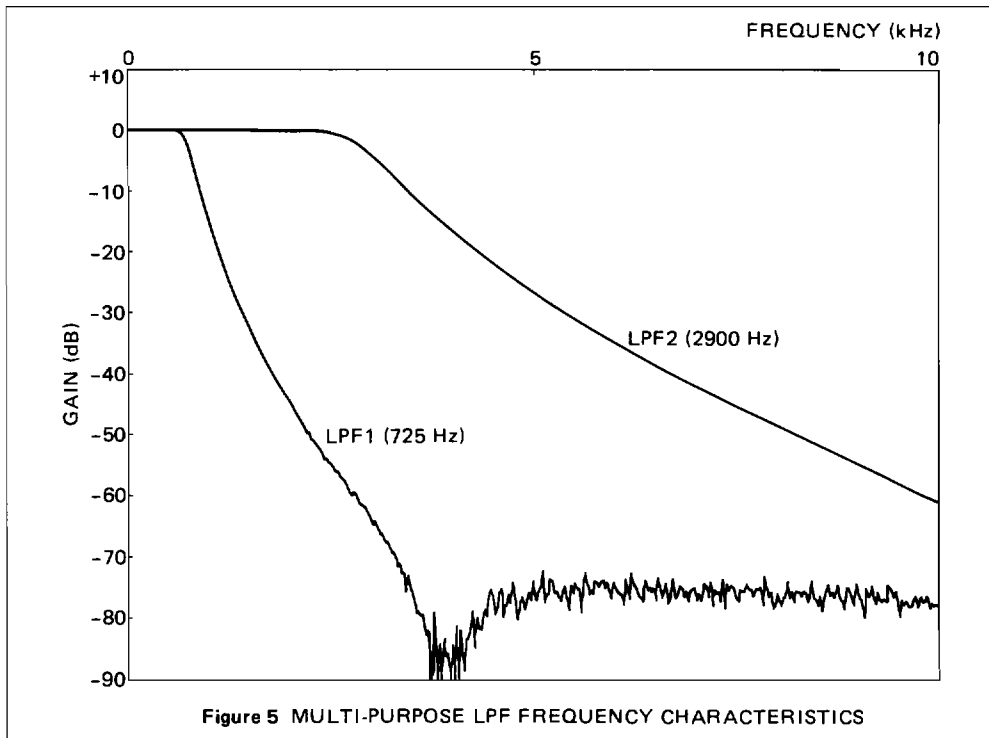
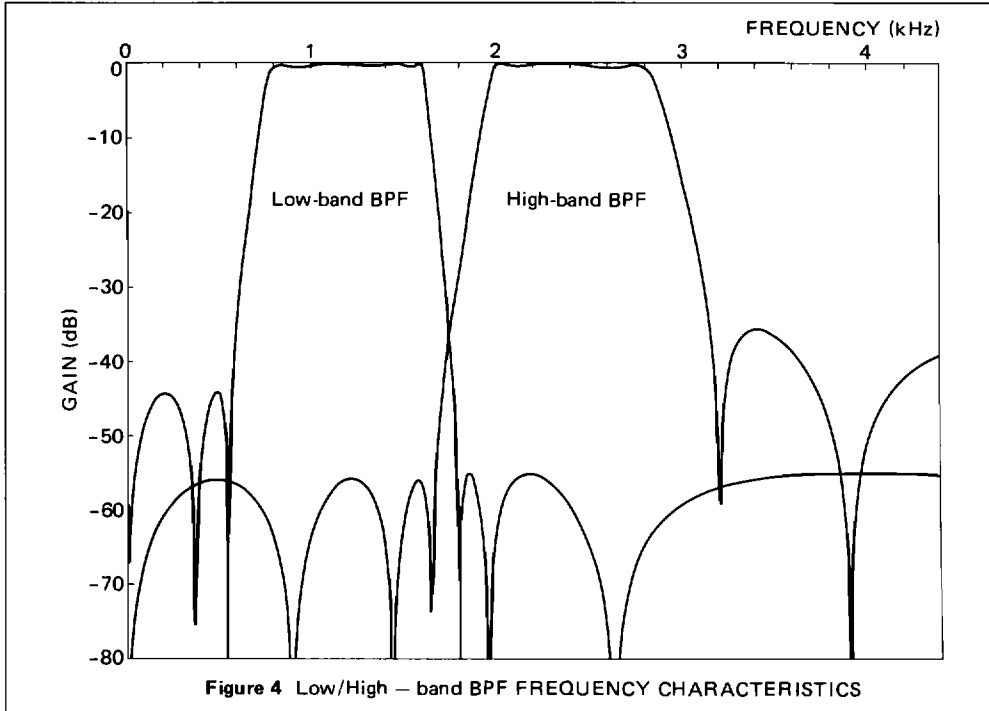

Figure 3 Transmit Data Timing Chart



**PIN DESCRIPTION**

Pin Name	Pin No.			Function																																																																													
	RS	GS	JS																																																																														
TD1 ~ TD8	1~8	3~5, 51~55	2~9	<p>Transmit signal digital data input for D/A conversion. These pins are 8 bit parallel two's complement data input pins. The data is loaded to the DA converter at the falling edge of <math>\overline{\text{WRITE}}</math>. TD1 is the LSB and TD8 is the MSB. Refer to Table 1 below.</p> <table border="1" style="width: 100%; border-collapse: collapse; text-align: center;"> <thead> <tr> <th>TD</th> <th>8</th> <th>7</th> <th>6</th> <th>5</th> <th>4</th> <th>3</th> <th>2</th> <th>1</th> <th>Total Value</th> <th>Nominal Output Voltage*</th> </tr> </thead> <tbody> <tr> <td>Plus Full Scale</td> <td>0</td> <td>1</td> <td>1</td> <td>1</td> <td>1</td> <td>1</td> <td>1</td> <td>1</td> <td>+127</td> <td>+2,172.1 mV</td> </tr> <tr> <td></td> <td></td> <td></td> <td></td> <td></td> <td></td> <td></td> <td></td> <td></td> <td>+126 ~ 1</td> <td></td> </tr> <tr> <td>Plus 0</td> <td>0</td> <td>0</td> <td>0</td> <td>0</td> <td>0</td> <td>0</td> <td>0</td> <td>0</td> <td>0</td> <td>0</td> </tr> <tr> <td>Minus 0</td> <td>1</td> <td>1</td> <td>1</td> <td>1</td> <td>1</td> <td>1</td> <td>1</td> <td>1</td> <td>-1</td> <td>-17.1 mV</td> </tr> <tr> <td></td> <td></td> <td></td> <td></td> <td></td> <td></td> <td></td> <td></td> <td></td> <td>-2 ~ 127</td> <td></td> </tr> <tr> <td>Minus Full Scale</td> <td>1</td> <td>0</td> <td>0</td> <td>0</td> <td>0</td> <td>0</td> <td>0</td> <td>0</td> <td>-128</td> <td>-2,189.2 mV</td> </tr> </tbody> </table> <p><b>Table 1</b> *The reference voltage for DA conversion is +2.5 V. This output voltage is defined at A<sub>OUT</sub>.</p>	TD	8	7	6	5	4	3	2	1	Total Value	Nominal Output Voltage*	Plus Full Scale	0	1	1	1	1	1	1	1	+127	+2,172.1 mV										+126 ~ 1		Plus 0	0	0	0	0	0	0	0	0	0	0	Minus 0	1	1	1	1	1	1	1	1	-1	-17.1 mV										-2 ~ 127		Minus Full Scale	1	0	0	0	0	0	0	0	-128	-2,189.2 mV
TD	8	7	6	5	4	3	2	1	Total Value	Nominal Output Voltage*																																																																							
Plus Full Scale	0	1	1	1	1	1	1	1	+127	+2,172.1 mV																																																																							
									+126 ~ 1																																																																								
Plus 0	0	0	0	0	0	0	0	0	0	0																																																																							
Minus 0	1	1	1	1	1	1	1	1	-1	-17.1 mV																																																																							
									-2 ~ 127																																																																								
Minus Full Scale	1	0	0	0	0	0	0	0	-128	-2,189.2 mV																																																																							
$\overline{\text{WRITE}}$	9	6	10	<p>This signal enables TD1 ~ TD8 pins to write data into the DA converter. The digital input from TD1 ~ TD8 is latched to the DA converter at the falling edge of <math>\overline{\text{WRITE}}</math> signal, and then converted to an analog signal.</p> <p>The analog output signal is renewed about 9 <math>\mu\text{sec}</math> after the falling edge of <math>\overline{\text{WRITE}}</math> signal. The cycle of this signal can be chosen from the range of 115 <math>\mu\text{sec}</math> ~ 143 <math>\mu\text{sec}</math>.</p>																																																																													
MCK	10	7	11	<p>A 3.6864 MHz clock signal should be applied to this pin. This is the time base for the operation of the MSM6950B.</p>																																																																													
$\overline{\text{START}}$	11	8	12	<p>This signal enables MSM6950B to start the AD conversion. This signal is also used to latch the input data which sets the amplitude of the AGC circuit. The input data is supplied from a digital signal processing demodulator chip.</p> <p>These two operations are performed at the falling edge of <math>\overline{\text{START}}</math>.</p> <p>The cycle of this signal can be chosen from the range of 98 <math>\mu\text{sec}</math> ~ 143 <math>\mu\text{sec}</math>.</p>																																																																													
$\overline{\text{READ}}$	12	9	13	<p>This is a control signal for 3-state output data bus line, RD1 ~ RD8. While this pin is the digital 0 state, the output bus is activated and the result of the AD conversion is output from RD1 ~ RD8 terminals.</p> <p>While this pin is at digital 1 state, the output bus is inactivated and RD1 ~ RD8 become input terminals.</p>																																																																													

Pin Name	Pin No.			Function																																																																																																																																							
	RS	GS	JS																																																																																																																																								
RD1 ~ RD8	13~20	10~23, 16~19	14~21	<p>These are I/O terminals controlled by <math>\overline{\text{START}}</math> and <math>\overline{\text{READ}}</math> terminals. When <math>\overline{\text{READ}}</math> is set at the digital 0 state, RD1 ~ RD8 become output terminals and the AD conversion result is output from these pins with 8 bit parallel two's complement format. Refer to Table 2.</p> <p>When <math>\overline{\text{READ}}</math> is set at digital 1 state, RD1 ~ RD8 become input terminals. The data input to these pins is loaded into the registers at the falling edge of <math>\overline{\text{START}}</math> signal. In this case, this data is used as the gain setting data for AGC circuit.</p> <p>Nominal absolute voltage gain of AGC circuit is described in Table 3. The dynamic range of the AGC circuit is about 48 dB as shown in Table 3.</p> <p><b><math>\overline{\text{READ}}</math> = Digital 0</b></p> <table border="1"> <thead> <tr> <th>RD<sub>7</sub></th> <th>RD<sub>6</sub></th> <th>RD<sub>5</sub></th> <th>RD<sub>4</sub></th> <th>RD<sub>3</sub></th> <th>RD<sub>2</sub></th> <th>RD<sub>1</sub></th> <th>RD<sub>0</sub></th> <th>Nominal Corresponding Voltage on the Input of AGC Circuit (AGC1)</th> </tr> </thead> <tbody> <tr> <td>0</td> <td>1</td> <td>1</td> <td>1</td> <td>1</td> <td>1</td> <td>1</td> <td>1</td> <td>+2,480.5 mV</td> </tr> <tr> <td colspan="9" style="text-align: center;">~ 19.5 mV Step</td> </tr> <tr> <td>0</td> <td>0</td> <td>0</td> <td>0</td> <td>0</td> <td>0</td> <td>0</td> <td>1</td> <td>+19.5 mV</td> </tr> <tr> <td>0</td> <td>0</td> <td>0</td> <td>0</td> <td>0</td> <td>0</td> <td>0</td> <td>0</td> <td>0</td> </tr> <tr> <td>1</td> <td>1</td> <td>1</td> <td>1</td> <td>1</td> <td>1</td> <td>1</td> <td>1</td> <td>-19.5 mV</td> </tr> <tr> <td colspan="9" style="text-align: center;">~ 19.5 mV Step</td> </tr> <tr> <td>1</td> <td>0</td> <td>0</td> <td>0</td> <td>0</td> <td>0</td> <td>0</td> <td>0</td> <td>-2,500 mV</td> </tr> </tbody> </table> <p style="text-align: center;"><b>Table 2</b></p> <p><b><math>\overline{\text{READ}}</math> = Digital 1</b></p> <table border="1"> <thead> <tr> <th>RD<sub>7</sub></th> <th>RD<sub>6</sub></th> <th>RD<sub>5</sub></th> <th>RD<sub>4</sub></th> <th>RD<sub>3</sub></th> <th>RD<sub>2</sub></th> <th>RD<sub>1</sub></th> <th>RD<sub>0</sub></th> <th>Nominal Absolute Voltage Gain of AGC Circuit (dB)</th> </tr> </thead> <tbody> <tr> <td>1</td> <td>1</td> <td>1</td> <td>1</td> <td>1</td> <td>1</td> <td>1</td> <td>1</td> <td>+43.8</td> </tr> <tr> <td>1</td> <td>1</td> <td>1</td> <td>1</td> <td>1</td> <td>1</td> <td>1</td> <td>0</td> <td>+43.6</td> </tr> <tr> <td colspan="9" style="text-align: center;">0.1875 dB Step</td> </tr> <tr> <td>0</td> <td>0</td> <td>0</td> <td>0</td> <td>0</td> <td>0</td> <td>1</td> <td>0</td> <td>-3.63</td> </tr> <tr> <td>0</td> <td>0</td> <td>0</td> <td>0</td> <td>0</td> <td>0</td> <td>0</td> <td>1</td> <td>-3.81</td> </tr> <tr> <td>0</td> <td>0</td> <td>0</td> <td>0</td> <td>0</td> <td>0</td> <td>0</td> <td>0</td> <td>-4.00</td> </tr> </tbody> </table> <p style="text-align: center;"><b>Table 3</b></p>	RD <sub>7</sub>	RD <sub>6</sub>	RD <sub>5</sub>	RD <sub>4</sub>	RD <sub>3</sub>	RD <sub>2</sub>	RD <sub>1</sub>	RD <sub>0</sub>	Nominal Corresponding Voltage on the Input of AGC Circuit (AGC1)	0	1	1	1	1	1	1	1	+2,480.5 mV	~ 19.5 mV Step									0	0	0	0	0	0	0	1	+19.5 mV	0	0	0	0	0	0	0	0	0	1	1	1	1	1	1	1	1	-19.5 mV	~ 19.5 mV Step									1	0	0	0	0	0	0	0	-2,500 mV	RD <sub>7</sub>	RD <sub>6</sub>	RD <sub>5</sub>	RD <sub>4</sub>	RD <sub>3</sub>	RD <sub>2</sub>	RD <sub>1</sub>	RD <sub>0</sub>	Nominal Absolute Voltage Gain of AGC Circuit (dB)	1	1	1	1	1	1	1	1	+43.8	1	1	1	1	1	1	1	0	+43.6	0.1875 dB Step									0	0	0	0	0	0	1	0	-3.63	0	0	0	0	0	0	0	1	-3.81	0	0	0	0	0	0	0	0	-4.00
RD <sub>7</sub>	RD <sub>6</sub>	RD <sub>5</sub>	RD <sub>4</sub>	RD <sub>3</sub>	RD <sub>2</sub>	RD <sub>1</sub>	RD <sub>0</sub>	Nominal Corresponding Voltage on the Input of AGC Circuit (AGC1)																																																																																																																																			
0	1	1	1	1	1	1	1	+2,480.5 mV																																																																																																																																			
~ 19.5 mV Step																																																																																																																																											
0	0	0	0	0	0	0	1	+19.5 mV																																																																																																																																			
0	0	0	0	0	0	0	0	0																																																																																																																																			
1	1	1	1	1	1	1	1	-19.5 mV																																																																																																																																			
~ 19.5 mV Step																																																																																																																																											
1	0	0	0	0	0	0	0	-2,500 mV																																																																																																																																			
RD <sub>7</sub>	RD <sub>6</sub>	RD <sub>5</sub>	RD <sub>4</sub>	RD <sub>3</sub>	RD <sub>2</sub>	RD <sub>1</sub>	RD <sub>0</sub>	Nominal Absolute Voltage Gain of AGC Circuit (dB)																																																																																																																																			
1	1	1	1	1	1	1	1	+43.8																																																																																																																																			
1	1	1	1	1	1	1	0	+43.6																																																																																																																																			
0.1875 dB Step																																																																																																																																											
0	0	0	0	0	0	1	0	-3.63																																																																																																																																			
0	0	0	0	0	0	0	1	-3.81																																																																																																																																			
0	0	0	0	0	0	0	0	-4.00																																																																																																																																			
VDD2	21	20	22	<p>Positive power supply, +5 V.</p> <p>This power supply is internally connected to the digital output logic circuitry RD1 ~ RD8 to avoid deterioration of the noise performance. The same power supply as to VDD1 should be used.</p>																																																																																																																																							
DG	22	22, 23	23, 24	Digital ground, 0 V.																																																																																																																																							
AG	23	24	25	Analog ground, 0 V.																																																																																																																																							
AGCC	24	25	26	An external capacitor of 1 $\mu\text{F}$ should be connected between AGCC and AG. This capacitor is necessary to compensate for the DC offset voltage generated in the AGC circuit.																																																																																																																																							

Pin Name	Pin No.			Function									
	RS	GS	JS										
VR1, VR2	25, 26	26, 29	27, 28	<p>The MSM6950B provides the voltage reference which is used for A/D and D/A conversions.</p> <p>The reference voltage is stabilized for variations of temperature or supply voltages, but tends to be different from chip to chip.</p> <p>Therefore, an external adjustment is necessary. The resistors used to adjust the reference voltage are connected to these pins as shown in Figure 6.</p> <div style="text-align: center;"> </div> <p><b>Figure 6 (MSM6950BRS)</b></p> <p>A bypass capacitor is required to decouple the VR and minimize noise. A capacitor with the value of 1 μF is recommended. The reference voltage on VR2 is determined by the following equation with a typical value of +2.5 V.</p> $V_{REF} = 1.2 \times \frac{R_8 + R_9}{R_8} \text{ [volts]}$									
AIN	27	30	29	Receive analog signal input pin. The maximum input level is about +7.2 dBm (5 Vp-p).									
DT, PT	28, 29	31, 32	30, 31	These pins control the transmit and receive analog signal paths for AC loop test, DTMF tone, guard tone and call progress tone. For details, refer to Table 8.									
AOUT	30	33	32	<p>This is the transmit analog signal output terminal. The output resistance is about 10 Ω and the load resistance should be more than 20 kΩ. The higher the load resistor is, the lower the power dissipation of MSM6950B.</p> <p>When the full scale digital data is input to DA, the output voltage on AOUT becomes as follows.</p> <table border="1" style="margin-left: auto; margin-right: auto;"> <thead> <tr> <th>Input Data to DA</th> <th>Reference Voltage</th> <th>Output Voltage (AOUT)</th> </tr> </thead> <tbody> <tr> <td>Plus Full Scale</td> <td>+2.5 V</td> <td>+2.17 V</td> </tr> <tr> <td>Minus Full Scale</td> <td></td> <td>-2.19 V</td> </tr> </tbody> </table>	Input Data to DA	Reference Voltage	Output Voltage (AOUT)	Plus Full Scale	+2.5 V	+2.17 V	Minus Full Scale		-2.19 V
Input Data to DA	Reference Voltage	Output Voltage (AOUT)											
Plus Full Scale	+2.5 V	+2.17 V											
Minus Full Scale		-2.19 V											

**Table 4**

Pin Name	Pin No.			Function																		
	RS	GS	JS																			
LT	31	35	33	<p>LT is used to provide the local AC loop test function. When a digital 1 is input to LT, the transmit analog signal bypasses the transmit analog filter and is directly routed to the receive analog filter. At this time, the transmit analog signal must be on the same channel as the receiver. The passband of the receive analog filter is selected by LT and MODE as shown in Table 5.</p> <table border="1"> <thead> <tr> <th>LT</th> <th>MODE</th> <th>Receive BPF's Passband</th> <th>AIN</th> <th>AOUT</th> </tr> </thead> <tbody> <tr> <td>1</td> <td>0</td> <td>2,000 ~ 2,800 Hz</td> <td rowspan="2">Open</td> <td rowspan="2">Shorted to AG (OV)</td> </tr> <tr> <td></td> <td>1</td> <td>800 ~ 1,600 Hz</td> </tr> <tr> <td>0</td> <td>*</td> <td colspan="3">Normal Operating State</td> </tr> </tbody> </table> <p style="text-align: center;"><b>Table 5</b></p>	LT	MODE	Receive BPF's Passband	AIN	AOUT	1	0	2,000 ~ 2,800 Hz	Open	Shorted to AG (OV)		1	800 ~ 1,600 Hz	0	*	Normal Operating State		
LT	MODE	Receive BPF's Passband	AIN	AOUT																		
1	0	2,000 ~ 2,800 Hz	Open	Shorted to AG (OV)																		
	1	800 ~ 1,600 Hz																				
0	*	Normal Operating State																				
FT	32	36	34	<p>FT controls the external transmit signal to be input to the MSM6950B and to send it over the telephone line through the AOUT terminal. When FT is in a digital 1 state, XIN is connected to the transmit filter input and external analog tones, such as DTMF tone, can be input to the MSM6950B through the XIN terminal.</p> <p>When a digital 0 is applied to FT, the output signal from DA converter is routed to the transmit filter input. This is the normal application for the MSM6950B.</p>																		
GT	33	37	35	<p>GT controls the signal to select the frequency of the guard tone and this is a necessary function to be used internationally. At the same time, the passband width of LPF is decided according to the frequency.</p> <table border="1"> <thead> <tr> <th>GT</th> <th>Guard Tone Frequency</th> <th>LPF's Passband</th> </tr> </thead> <tbody> <tr> <td>0</td> <td>550 Hz</td> <td>0 ~ 725 Hz</td> </tr> <tr> <td>1</td> <td>1,800 Hz</td> <td>0 ~ 2,900 Hz</td> </tr> </tbody> </table> <p style="text-align: center;"><b>Table 6</b></p> <p>LPF plays a role in rejecting harmonic components from the originated guard tone. In addition to it, this LPF can be also used in the receiver as a band limiting filter during call progress tone detection.</p>	GT	Guard Tone Frequency	LPF's Passband	0	550 Hz	0 ~ 725 Hz	1	1,800 Hz	0 ~ 2,900 Hz									
GT	Guard Tone Frequency	LPF's Passband																				
0	550 Hz	0 ~ 725 Hz																				
1	1,800 Hz	0 ~ 2,900 Hz																				
XIN	34	38	36	<p>XIN is an external analog signal input. As described in the paragraph for FT, XIN is activated when FT is in a digital 1 state. The maximum input level is about +7.2 dBm (5 Vp-p).</p>																		

Pin Name	Pin No.			Function												
	RS	GS	JS													
SP	35	39	37	SP should be connected to a digital 0 in actual applications.												
MODE	36	40	38	<p>MODE determines the role of each BPF by controlling SWT and SWR as shown in the circuit configuration.</p> <p>When a digital 0 is applied to this pin, the low channel BPF is assigned to the transmitter and the high channel BPF is assigned to the receiver. This condition is called the "Originate mode". When a digital 1 is input to MODE, the positions of BPFs are reversed and this is called as "Answer mode".</p> <p>During the AC loop back test, the frequency band used for this test becomes the receiver's channel determined by MODE.</p> <table border="1" style="width: 100%; border-collapse: collapse;"> <thead> <tr> <th>MODE</th> <th>Mode</th> <th>Transmit Filter</th> <th>Receive Filter</th> </tr> </thead> <tbody> <tr> <td>0</td> <td>Originate</td> <td>L · BPF (800 ~ 1,600 Hz)</td> <td>H · BPF (2,000 ~ 2,800 Hz)</td> </tr> <tr> <td>1</td> <td>Answer</td> <td>H · BPF (2,000 ~ 2,800 Hz)</td> <td>L · BPF (800 ~ 1,600 Hz)</td> </tr> </tbody> </table>	MODE	Mode	Transmit Filter	Receive Filter	0	Originate	L · BPF (800 ~ 1,600 Hz)	H · BPF (2,000 ~ 2,800 Hz)	1	Answer	H · BPF (2,000 ~ 2,800 Hz)	L · BPF (800 ~ 1,600 Hz)
MODE	Mode	Transmit Filter	Receive Filter													
0	Originate	L · BPF (800 ~ 1,600 Hz)	H · BPF (2,000 ~ 2,800 Hz)													
1	Answer	H · BPF (2,000 ~ 2,800 Hz)	L · BPF (800 ~ 1,600 Hz)													
RFO	37	41	39	<p>RFO is the analog signal output of the receive filter.</p> <p>This signal is to be connected to the AGC circuit through an external capacitor of 0.1 <math>\mu</math>F. The load resistance should be more than 20 k<math>\Omega</math>. The maximum voltage swing is about 5 Vp-p.</p>												
AGCI	38	44	40	<p>AGCI is the input pin of the AGC circuit and is connected to RFO through an external capacitor as shown in Figure 7. The role of the capacitor is to avoid the DC offset generated in the receive filter. The input resistance is high and the maximum input voltage swing is about 5 Vp-p.</p> <div style="text-align: center;"> </div>												

Table 7

Figure 7 (MSM6950BRS)

Pin Name	Pin No.			Function
	RS	GS	JS	
GR2, GR1	39, 40	45, 47	41, 42	<p>The output guard tone level can be adjusted by using external resistors as shown in Figure 8.</p> <p style="text-align: right;"><b>Figure 8 (MSM6950BRS)</b></p> <p>The approximate output tone level is determined by the following equation.</p> $V_{AOUT} = 20 \cdot \log \frac{R_{11} + R_{12}}{R_{11}} - 15 \text{ [dBm]}$ <p>In Bell standard sets, the guard tone function is not used.</p>
VSS	41	48	43	Negative power supply, -5 V.
VDD <sub>1</sub>	42	21, 49	44	Positive power supply +5 V.

MSM6950BRS CIRCUIT WIRING ILLUSTRATION

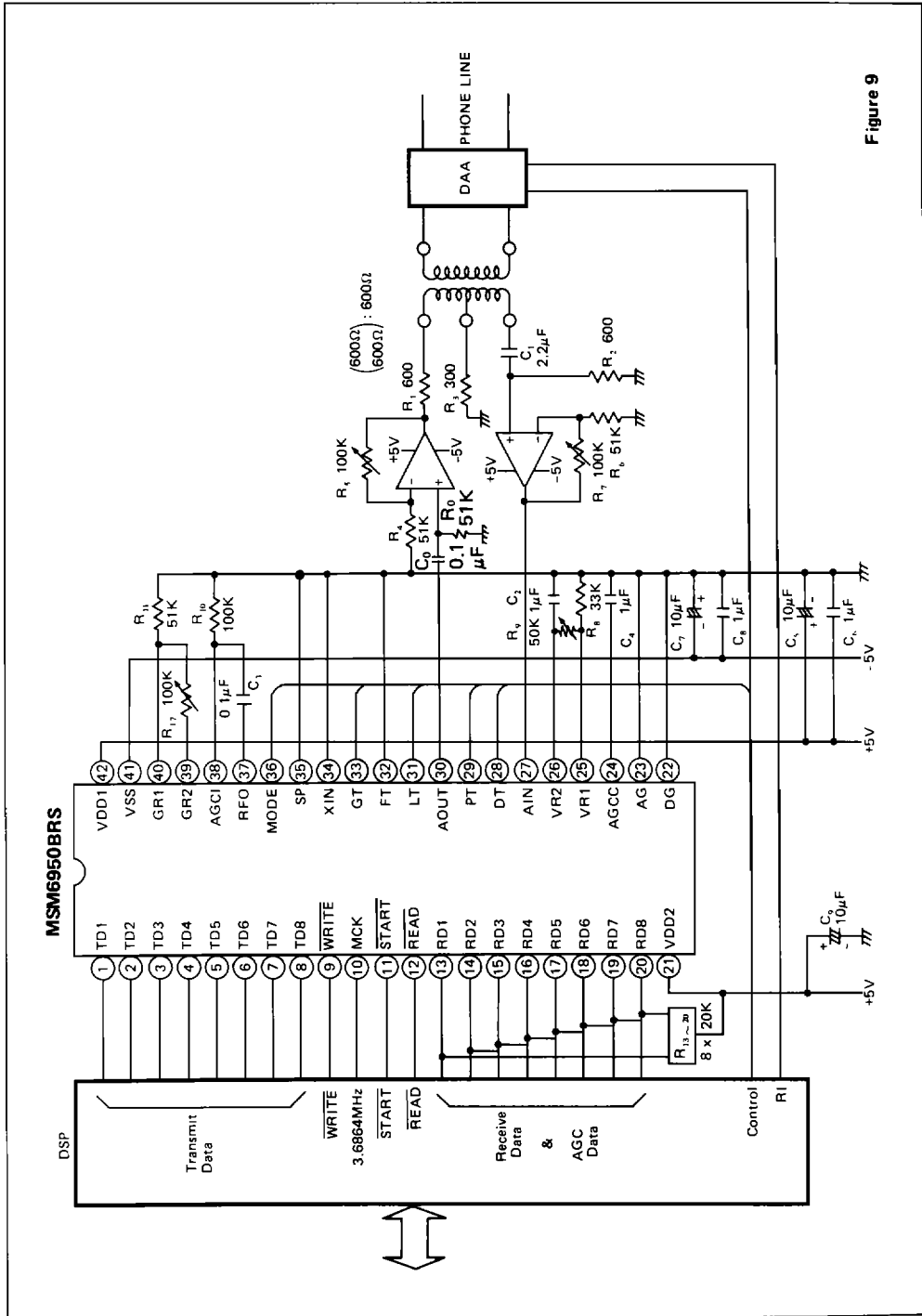

Figure 9

## APPLICATION INFORMATION

1. Typical Master Clock (MCK) Frequency and  $\overline{\text{WRITE}}$ ,  $\overline{\text{START}}$ ,  $\overline{\text{READ}}$  signals.

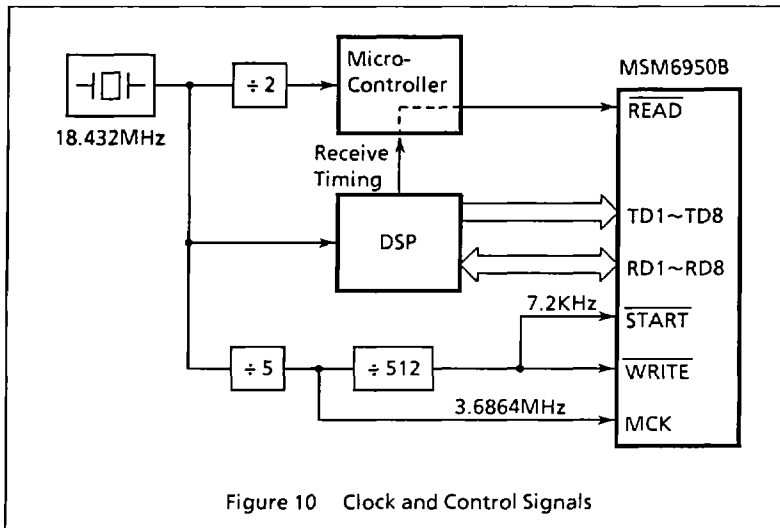

Figure 10 shows the typical design for the operating clock and control signals.

It is desirable to use a single time base for the best noise performance of the modem system.

## 2 Originate Transmission Mode

The signal path in this mode is shown in Figure 11.

The low band signal must be transmitted and the high band signal must be received. MODE determines the positions of two BPFs by controlling SW1, SW2, SWR1 and SWR2. When MODE is in the digital 0 state, the low channel BPF is assigned to the transmitter and the high channel BPF is assigned to the receiver. Both DT and PT should be in the digital 1 state so that the guard tone function is disabled.

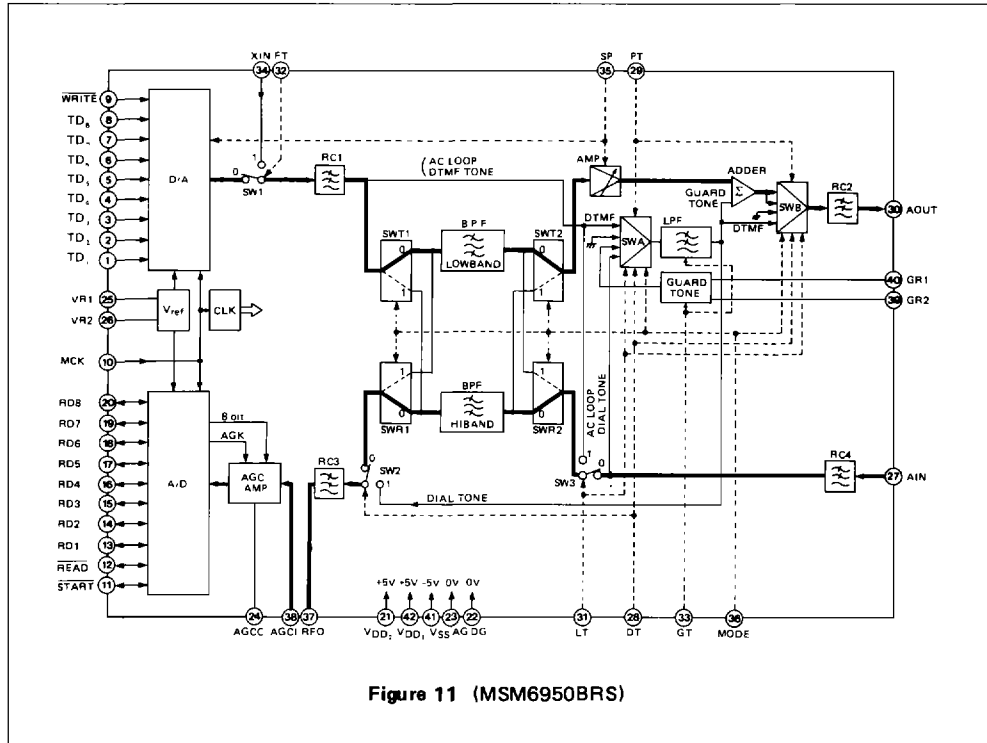

Figure 11 (MSM6950BRS)



#### 4 Tone Transmit Mode

The signal path in this mode is shown in Figure 13.

The LPF shown here has two cut-off frequencies (725 Hz/2900 Hz). So, this mode is useful for DTMF signaling among other things. Refer to Table 9.

When the transmit signal is passed from the DA donverter to the low cut-off frequency (725 Hz) the LPF, and the AOUT signal level changed less than  $\pm 2.5$  dB by the timing of WRITE signal and internal clock.

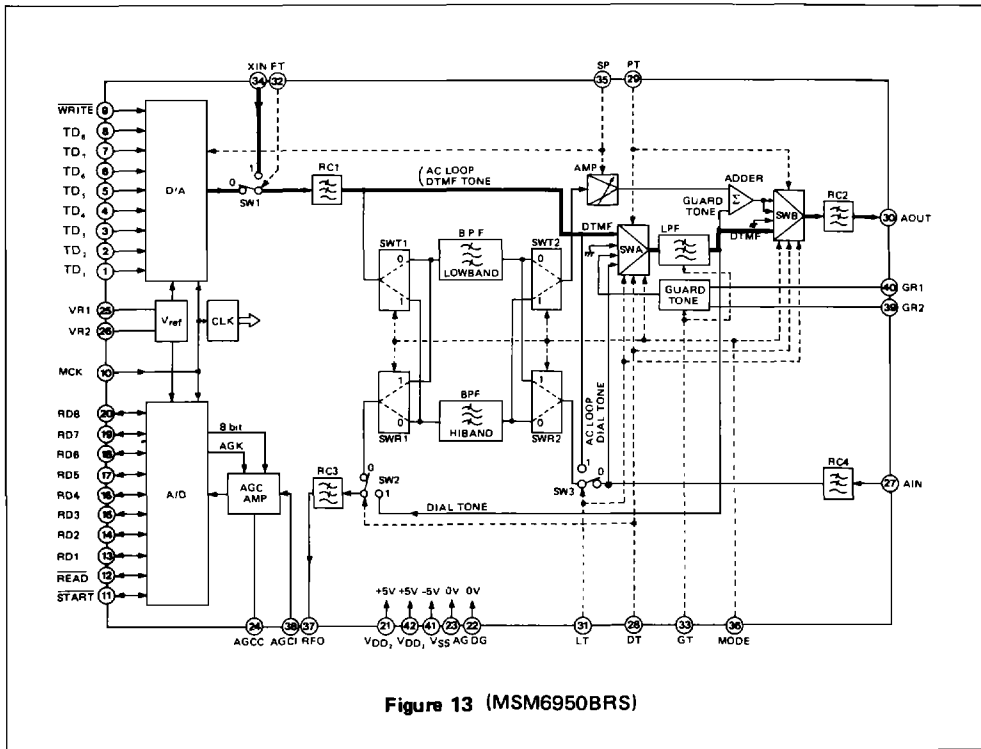

Figure 13 (MSM6950BRS)

### 5 Tone Receive Mode

The signal path in this mode is shown in Figure 14.

As LPF shown here has two cut-off frequencies - 725 Hz and 2900 Hz. This mode is useful for call progress tone monitoring with dial tones. Refer to Table 8. In this mode, AOUT is connected to AG (0 V) internally.

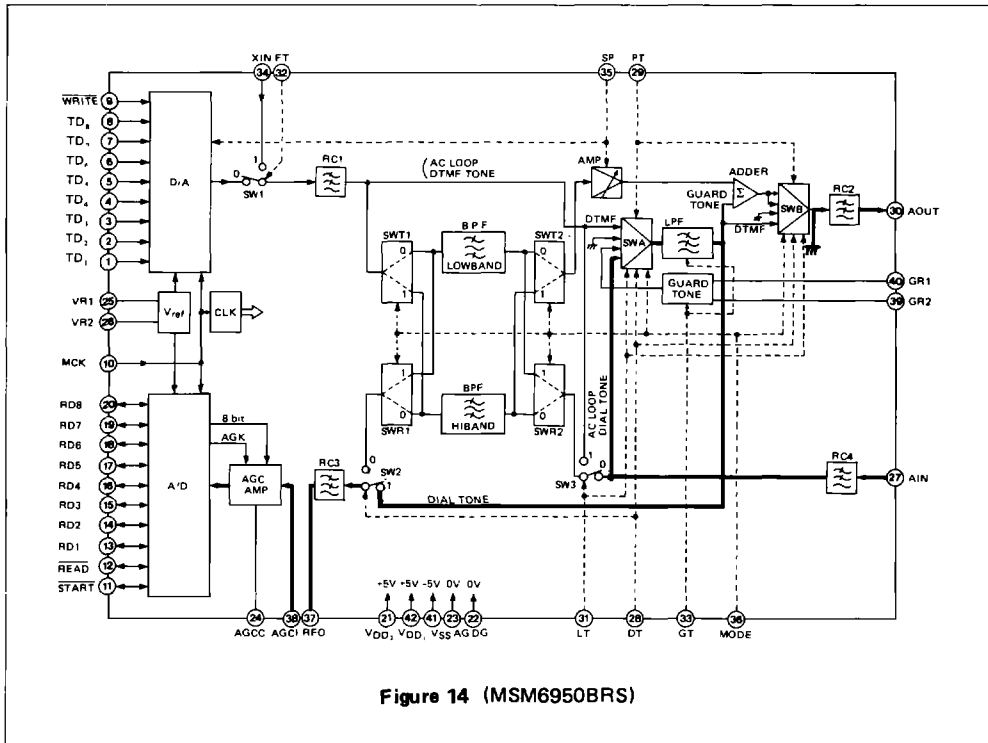

Figure 14 (MSM6950BRS)

## 6 AC Loop-back Test Mode

The signal path in this mode is shown in Figure 15.

The modem system has to receive its own transmit signal to check operation.

In this mode, the transmit BPF left out of the signal route and the channel used for AC Loop-back test is determined by the receiver's channel assigned by MODE. Refer to Table 8.

AOUT is connected to AG (0V) internally.

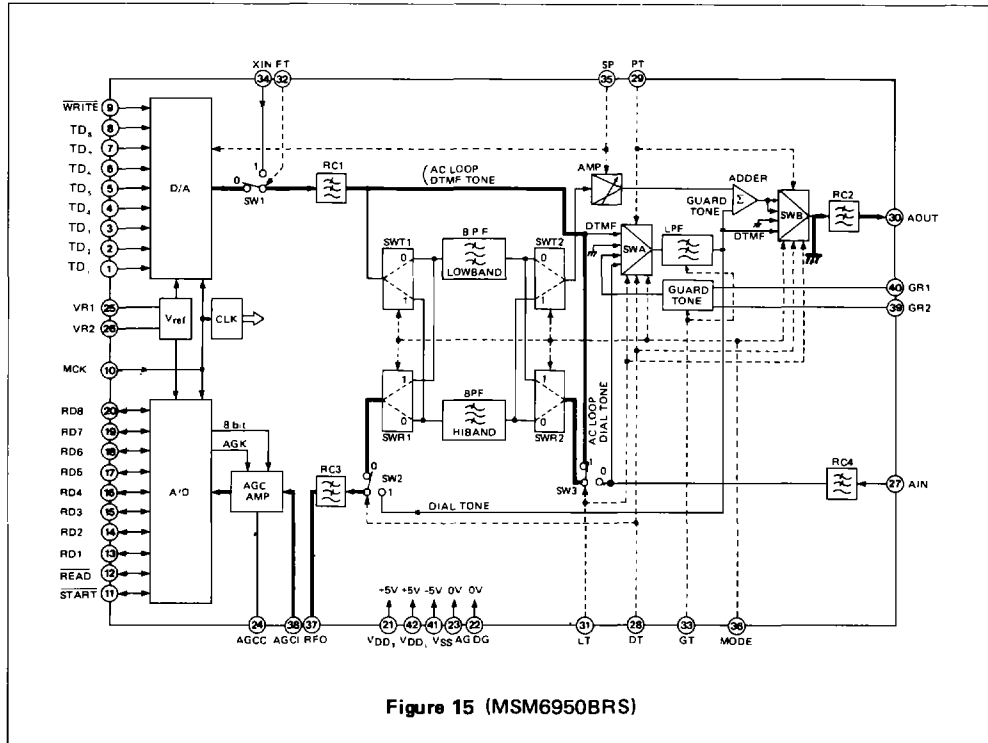

Figure 15 (MSM6950BRS)

Control Signal				Transmitter			Receiver		Note		
DT	PT	MODE	GT	SP	LT	Pass Band*1	Gain*1	Guard Tone		Pass Band*2	Gain*2
1	1	0	X	0	0	800~1600Hz	+2.0dB		2000~2800Hz	0dB	FSK DPSK QAM
1	1	1	X	0	0	2000~2800Hz	+2.0dB		800~1600Hz	0dB	
0	0	1	0	0	0	2000~2800Hz	+2.0dB	550Hz	800~1600Hz	0dB	
0	0	1	1	0	0	2000~2800Hz	+2.0dB	1800Hz	800~1600Hz	0dB	Extra Tone/DTMF Tone Transmitting
0	1	0	0	0	0	0~725Hz	+1.0dB		2000~2800Hz	0dB	
0	1	1	0	0	0	0~725Hz	+1.0dB		800~1600Hz	0dB	
0	1	0	1	0	0	0~2900Hz	+2.0dB		2000~2800Hz	0dB	Filtering for Call Progress Tone
0	1	1	1	0	0	0~2900Hz	+2.0dB		800~1600Hz	0dB	
1	0	X	0	X	0	*3			0~725Hz	-1.0dB	
1	0	X	1	X	0	*3			0~2900Hz	0dB	AC Loop- back Test
1	1	0	X	0	1	*3			2000~2800Hz	0dB	
0	0	0	X	0	1	*3			2000~2800Hz	0dB	
1	1	1	X	0	1	*3			800~1600Hz	0dB	FSK DPSK QAM
0	0	1	X	0	1	*3			800~1600Hz	0dB	

\*1 XIN → AOUT

\*2 AIN → RFO

\*3 AOUT is connected to Ground.

Table 8 Various Operating Modes