

MM54HC73/MM74HC73 Dual J-K Flip-Flops with Clear

General Description

These J-K Flip-Flops utilize advanced silicon-gate CMOS technology. They possess the high noise immunity and low power dissipation of standard CMOS integrated circuits. These devices can drive 10 LS-TTL loads.

These flip-flops are edge sensitive to the clock input and change state on the negative going transition of the clock pulse. Each one has independent, J, K, CLOCK, and CLEAR inputs and Q and \bar{Q} outputs. CLEAR is independent of the clock and accomplished by a low level on the input.

The 54HC/74HC logic family is functionally as well as pin-out compatible with the standard 54LS/74LS logic family.

All inputs are protected from damage due to static discharge by internal diode clamps to V_{CC} and ground.

Features

- Typical propagation delay: 16 ns
- Wide operating voltage range: 2–6V
- Low input current: 1 μ A maximum
- Low quiescent current: 40 μ A (74HC Series)
- High output drive: 10 LS-TTL loads

Connection and Logic Diagrams

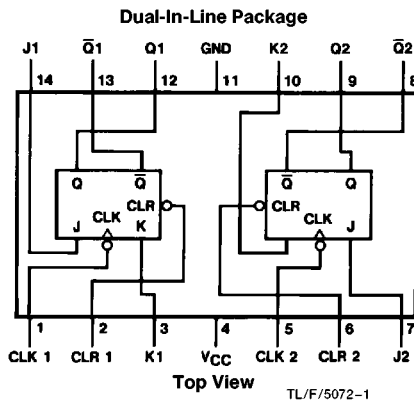

Order Number MM54HC73 or MM74HC73

Truth Table

Inputs				Outputs	
CLR	CLK	J	K	Q	\bar{Q}
L	X	X	X	L	H
H	↓	L	L	Q0	$\bar{Q}0$
H	↓	H	L	H	L
H	↓	L	H	L	H
H	↓	H	H	TOGGLE	TOGGLE
H	H	X	X	Q0	$\bar{Q}0$

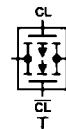
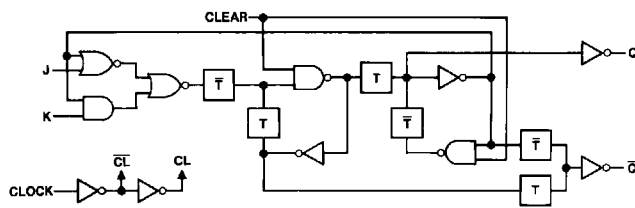

Absolute Maximum Ratings (Notes 1 & 2)

If Military/Aerospace specified devices are required, please contact the National Semiconductor Sales Office/Distributors for availability and specifications.

Supply Voltage (V_{CC})	-0.5 to +7.0V
DC Input Voltage (V_{IN})	-1.5 to $V_{CC} + 1.5V$
DC Output Voltage (V_{OUT})	-0.5 to $V_{CC} + 0.5V$
Clamp Diode Current (I_{IK}, I_{OK})	± 20 mA
DC Output Current, per pin (I_{OUT})	± 25 mA
DC V_{CC} or GND Current, per pin (I_{CC})	± 50 mA
Storage Temperature Range (T_{STG})	-65°C to +150°C
Power Dissipation (P_D) (Note 3)	600 mW
S.O. Package only	500 mW
Lead Temperature (T_L) (Soldering 10 seconds)	260°C

Operating Conditions

	Min	Max	Units
Supply Voltage (V_{CC})	2	6	V
DC Input or Output Voltage (V_{IN}, V_{OUT})	0	V_{CC}	V
Operating Temp. Range (T_A)			
MM74HC	-40	+85	°C
MM54HC	-55	+125	°C
Input Rise or Fall Times (t_r, t_f)			
$V_{CC} = 2.0V$		1000	ns
$V_{CC} = 4.5V$		500	ns
$V_{CC} = 6.0V$		400	ns

DC Electrical Characteristics (Note 4)

Symbol	Parameter	Conditions	V_{CC}	$T_A = 25^\circ C$		74HC	54HC	Units
						$T_A = -40$ to $85^\circ C$	$T_A = -55$ to $125^\circ C$	
				Typ	Guaranteed Limits			
V_{IH}	Minimum High Level Input Voltage		2.0V		1.5	1.5	1.5	V
			4.5V		3.15	3.15	3.15	V
			6.0V		4.2	4.2	4.2	V
V_{IL}	Maximum Low Level Input Voltage**		2.0V		0.5	0.5	0.5	V
			4.5V		1.35	1.35	1.35	V
			6.0V		1.8	1.8	1.8	V
V_{OH}	Minimum High Level Output Voltage	$V_{IN} = V_{IH}$ or V_{IL} $ I_{OUT} \leq 20 \mu A$	2.0V	2.0	1.9	1.9	1.9	V
			4.5V	4.5	4.4	4.4	4.4	V
			6.0V	6.0	5.9	5.9	5.9	V
		$V_{IN} = V_{IH}$ or V_{IL} $ I_{OUT} \leq 4.0$ mA $ I_{OUT} \leq 5.2$ mA	4.5V	4.2	3.98	3.84	3.7	V
			6.0V	5.7	5.48	5.34	5.2	V
V_{OL}	Maximum Low Level Output Voltage	$V_{IN} = V_{IH}$ or V_{IL} $ I_{OUT} \leq 20 \mu A$	2.0V	0	0.1	0.1	0.1	V
			4.5V	0	0.1	0.1	0.1	V
			6.0V	0	0.1	0.1	0.1	V
		$V_{IN} = V_{IH}$ or V_{IL} $ I_{OUT} \leq 4.0$ mA $ I_{OUT} \leq 5.2$ mA	4.5V	0.2	0.26	0.33	0.4	V
			6.0V	0.2	0.26	0.33	0.4	V
I_{IN}	Maximum Input Current	$V_{IN} = V_{CC}$ or GND	6.0V		± 0.1	± 1.0	± 1.0	μA
I_{CC}	Maximum Quiescent Supply Current	$V_{IN} = V_{CC}$ or GND $I_{OUT} = 0 \mu A$	6.0V		4.0	40	80	μA

Note 1: Absolute Maximum Ratings are those values beyond which damage to the device may occur.

Note 2: Unless otherwise specified all voltages are referenced to ground.

Note 3: Power Dissipation temperature derating — plastic "N" package: -12 mW/°C from 65°C to 85°C; ceramic "J" package: -12 mW/°C from 100°C to 125°C.

Note 4: For a power supply of 5V $\pm 10\%$ the worst case output voltages (V_{OH} and V_{OL}) occur for HC at 4.5V. Thus the 4.5V values should be used when designing with this supply. Worst case V_{IH} and V_{IL} occur at $V_{CC} = 5.5V$ and 4.5V respectively. (The V_{IH} value at 5.5V is 3.85V.) The worst case leakage current (I_{IN} , I_{CC} , and I_{OZ}) occur for CMOS at the higher voltage and so the 6.0V values should be used.

** V_{IL} limits are currently tested at 20% of V_{CC} . The above V_{IL} specification (30% of V_{CC}) will be implemented no later than Q1, CY'89.

AC Electrical Characteristics $V_{CC}=5V, T_A=25^\circ C, C_L=15\text{ pF}, t_r=t_f=6\text{ ns}$

Symbol	Parameter	Conditions	Typ	Guaranteed Limit	Units
f_{MAX}	Maximum Operating Frequency		50	30	MHz
t_{PHL}, t_{PLH}	Maximum Propagation Delay Clock to Q or \bar{Q}		16	21	ns
t_{PHL}, t_{PLH}	Maximum Propagation Delay Clear to Q or \bar{Q}		21	26	ns
t_{REM}	Minimum Removal Time, Clear to Clock		10	20	ns
t_S	Minimum Setup Time, J or K to Clock		14	20	ns
t_H	Minimum Hold Time J or K to Clock		-3	0	ns
t_W	Minimum Pulse Width, Clock or Clear		10	16	ns

AC Electrical Characteristics $C_L=50\text{ pF}, t_r=t_f=6\text{ ns}$ (unless otherwise specified)

Symbol	Parameter	Conditions	V_{CC}	$T_A=25^\circ C$		74HC	54HC	Units
						$T_A=-40\text{ to }85^\circ C$	$T_A=-55\text{ to }125^\circ C$	
				Typ	Guaranteed Limits			
f_{MAX}	Maximum Operating Frequency		2.0V	9	5	4	3	MHz
			4.5V	45	27	21	18	MHz
			6.0V	53	32	25	21	MHz
t_{PHL}, t_{PLH}	Maximum Propagation Delay Clock to Q or \bar{Q}		2.0V	70	126	160	185	ns
			4.5V	18	25	32	37	ns
			6.0V	15	21	27	32	ns
t_{PHL}, t_{PLH}	Maximum Propagation Delay Clear to Q or \bar{Q}		2.0V	126	155	194	250	ns
			4.5V	25	31	39	47	ns
			6.0V	21	26	32	40	ns
t_{REM}	Minimum Removal Time Clear to Clock		2.0V	55	100	125	150	ns
			4.5V	11	20	25	30	ns
			6.0V	9	17	21	25	ns
t_S	Minimum Setup Time J or K to Clock		2.0V	77	100	125	150	ns
			4.5V	15.4	20	25	30	ns
			6.0V	13	17	21	25	ns
t_H	Minimum Hold Time J or K from Clock		2.0V	-3	0	0	0	ns
			4.5V	-3	0	0	0	ns
			6.0V	-3	0	0	0	ns
t_W	Minimum Pulse Width Clock or Clear		2.0V	55	80	100	120	ns
			4.5V	11	16	20	24	ns
			6.0V	9	14	18	21	ns
t_{TLH}, t_{THL}	Maximum Output Rise and Fall Time		2.0V	30	75	95	110	ns
			4.5V	8	15	19	22	ns
			6.0V	7	13	16	19	ns
t_r, t_f	Maximum Input Rise and Fall Time		2.0V		1000	1000	1000	ns
			4.5V		500	500	500	ns
			6.0V		400	400	400	ns
C_{PD}	Power Dissipation Capacitance (Note 5)	(per flip-flop)		80				pF
C_{IN}	Maximum Input Capacitance			5	10	10	10	pF

Note 5: C_{PD} determines the no load dynamic power consumption, $P_D = C_{PD} V_{CC}^2 f + I_{CC} V_{CC}$, and the no load dynamic current consumption, $I_S = C_{PD} V_{CC} f + I_{CC}$.

Typical Applications

N Bit Binary Ripple Counter with Enable and Reset

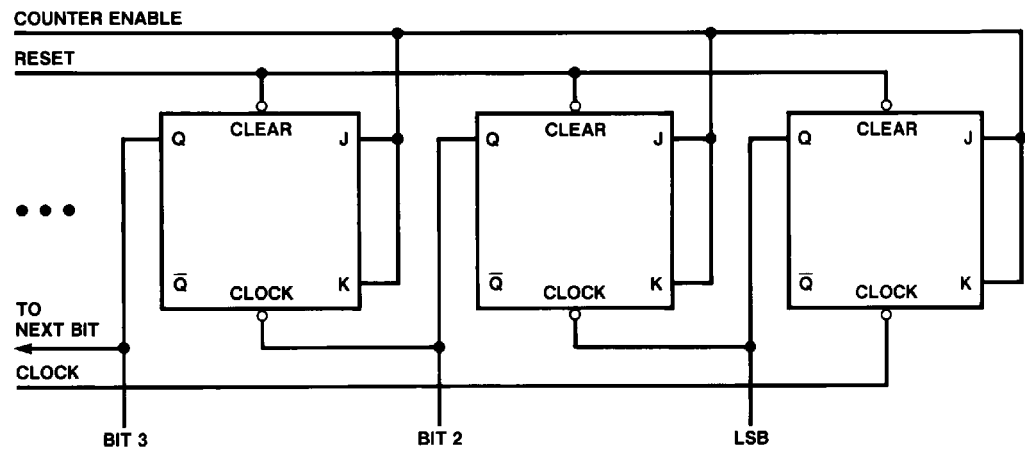

N Bit Shift Register with Clear

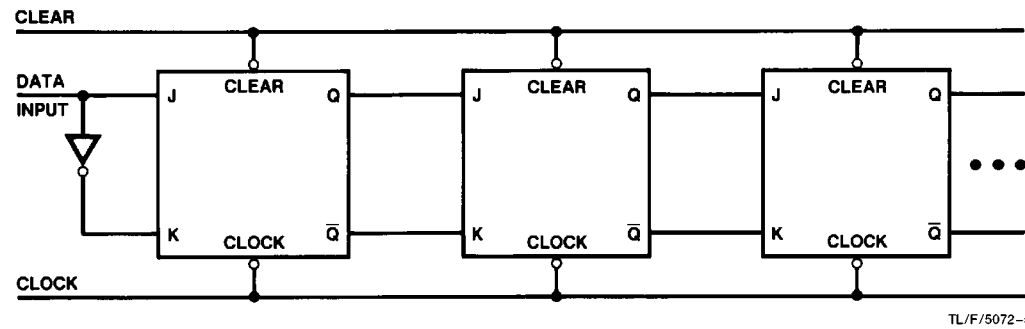

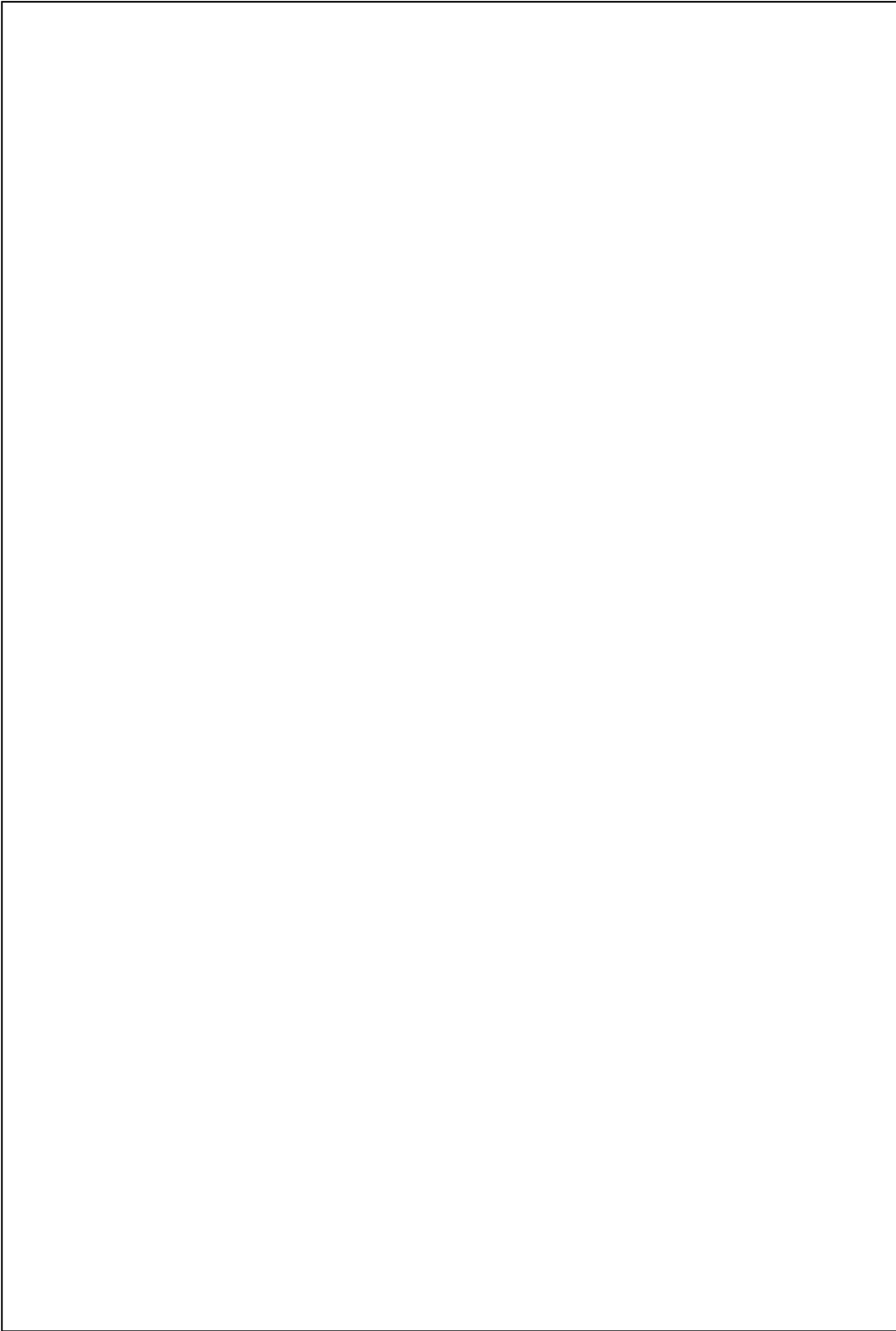

Physical Dimensions inches (millimeters)

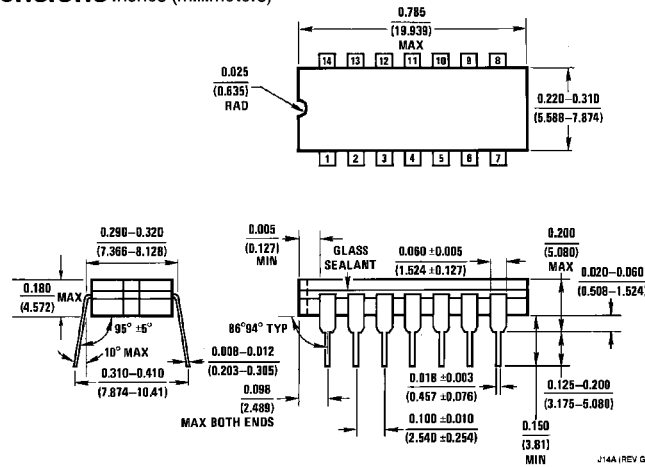

Dual-In Line Package (J)
Order Number MM54HC73J or MM74HC73J
NS Package J14A

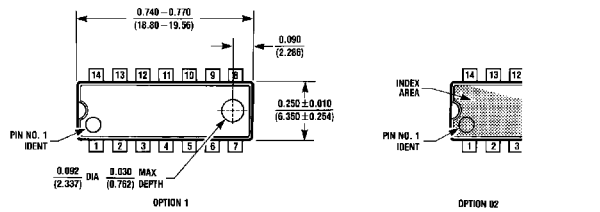

Dual-In Line Package (N)
Order Number MM74HC73N
NS Package N14A

LIFE SUPPORT POLICY

NATIONAL'S PRODUCTS ARE NOT AUTHORIZED FOR USE AS CRITICAL COMPONENTS IN LIFE SUPPORT DEVICES OR SYSTEMS WITHOUT THE EXPRESS WRITTEN APPROVAL OF THE PRESIDENT OF NATIONAL SEMICONDUCTOR CORPORATION. As used herein:

1. Life support devices or systems are devices or systems which, (a) are intended for surgical implant into the body, or (b) support or sustain life, and whose failure to perform, when properly used in accordance with instructions for use provided in the labeling, can be reasonably expected to result in a significant injury to the user.
2. A critical component is any component of a life support device or system whose failure to perform can be reasonably expected to cause the failure of the life support device or system, or to affect its safety or effectiveness.



National Semiconductor Corporation
 1111 West Bardin Road
 Arlington, TX 76017
 Tel: 1(800) 272-9959
 Fax: 1(800) 737-7018

National Semiconductor Europe
 Fax: (+49) 0-180-530 85 86
 Email: cnjwge@tevm2.nsc.com
 Deutsch Tel: (+49) 0-180-530 85 85
 English Tel: (+49) 0-180-532 78 32
 Français Tel: (+49) 0-180-532 93 58
 Italiano Tel: (+49) 0-180-534 16 80

National Semiconductor Hong Kong Ltd.
 13th Floor, Straight Block,
 Ocean Centre, 5 Canton Rd.
 Tsimshatsui, Kowloon
 Hong Kong
 Tel: (852) 2737-1600
 Fax: (852) 2736-9960

National Semiconductor Japan Ltd.
 Tel: 81-043-299-2309
 Fax: 81-043-299-2408

National does not assume any responsibility for use of any circuitry described, no circuit patent licenses are implied and National reserves the right at any time without notice to change said circuitry and specifications.