

## SITAC® AC Switches Without Zero Voltage Switch

- AC switch without zero-voltage detector
- Electrically insulated between input and output circuit
- Microcomputer-compatible by very low trigger current
- UL-tested (file no. E 52744), code letter "J"
- Available with the following options:
  - Option 1: VDE 0884-approved
  - Option 6: Pins in 10.16 mm spacing
  - Option 7: Pins for surface mounting

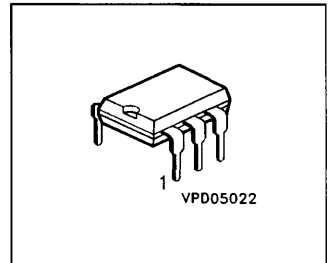

Type	Opt.	$V_{DRM}$	$I_{TRMS}$	$I_{FT}$	$dv/dt_{cr}$	Marking	Ordering Code
BRT 21 H	-	400 V	300 mA	2 mA	10 kV/ $\mu$ s	BRT 21 H	C67079-A1020-A6
BRT 21 H	1 + 6	400 V	300 mA	2 mA	10 kV/ $\mu$ s	BRT 21 H	C67079-A1050-A16
BRT 22 H	-	600 V	300 mA	2 mA	10 kV/ $\mu$ s	BRT 22 H	C67079-A1021-A6
BRT 22 H	1	600 V	300 mA	2 mA	10 kV/ $\mu$ s	BRT 22 H	C67079-A1051-A5
BRT 22 H	7	600 V	300 mA	2 mA	10 kV/ $\mu$ s	BRT 22 H	C67079-A1051-A11
BRT 22 H	1 + 6	600 V	300 mA	2 mA	10 kV/ $\mu$ s	BRT 22 H	C67079-A1051-A16
BRT 22 H	1 + 7	600 V	300 mA	2 mA	10 kV/ $\mu$ s	BRT 22 H	C67079-A1051-A17
BRT 22 M	-	600 V	300 mA	3 mA	10 kV/ $\mu$ s	BRT 22 M	C67079-A1021-A10
BRT 22 M	1	600 V	300 mA	3 mA	10 kV/ $\mu$ s	BRT 22 M	C67079-A1051-A6
BRT 23 H	-	800 V	300 mA	2 mA	10 kV/ $\mu$ s	BRT 23 H	C67079-A1022-A6
BRT 23 H	6	800 V	300 mA	2 mA	10 kV/ $\mu$ s	BRT 23 H	C67079-A1052-A8
BRT 23 H	7	800 V	300 mA	2 mA	10 kV/ $\mu$ s	BRT 23 H	C67079-A1052-A11
BRT 23 H	1 + 6	800 V	300 mA	2 mA	10 kV/ $\mu$ s	BRT 23 H	C67079-A1052-A14
BRT 23 M	-	800 V	300 mA	3 mA	10 kV/ $\mu$ s	BRT 23 M	C67079-A1022-A10

Information	Package	Pin Configuration					
		1	2	3	4	5	6
50 pcs per tube	P-DIP-6	Anode	Kathode	not connected	A1	do not connect	A2

**Maximum Ratings**, at  $T_j = 25\text{ °C}$ , unless otherwise specified.

### AC Switch

Parameter	Symbol	Value	Unit
Max. Power dissipation	$P_{\text{tot}}$	630	mW
Chip or operating temperature	$T_j$	-40 ...+ 100	°C
Storage temperature	$T_{\text{stg}}$	-40 ...+ 150	
Insulation test voltage <sup>1)</sup> between input/output circuit (climate in acc. with DIN 40 046, part 2, Nov. 74)	$V_{\text{IS}}$	5300	$V_{\text{RMS}}$
Reference voltage in acc. with VDE 0110 b (insulation group C)	$V_{\text{ref}}$	500 600	$V_{\text{RMS}}$ $V_{\text{DC}}$
Creepage tracking resistance (in acc. with DIN IEC 112/VDE 0303, part 1)	$C_{\text{TI}}$	175	(group IIIa acc. to DIN VDE 0109)
Insulation resistance $V_{\text{IO}} = 500\text{ V}$ , $T_{\text{A}} = 25\text{ °C}$ $V_{\text{IO}} = 500\text{ V}$ , $T_{\text{A}} = 100\text{ °C}$	$R_{\text{is}}$	$\geq 10^{12}$ $\geq 10^{11}$	$\Omega$
DIN humidity category, DIN 40 040		F	
Creepage distance (input/output circuit)	-	$\geq 7.2$	mm
Clearance (input/output circuit)	-	$\geq 7.2$	

### Input Circuit

Parameter	Symbol	Value	Unit
Param VR	$V_{\text{R}}$	6	V
Continuous forward current	$I_{\text{F}}$	20	mA
Surge forward current,	$I_{\text{FSM}(I)}$	1.5	A
Max. power dissipation, $t \leq 10\text{ }\mu\text{s}$	$P_{\text{tot}}$	30	mW

### Output Circuit

Parameter	Symbol	BRT	BRT	BRT	Unit
		21	22	23	
Repetitive peak off-state voltage	$V_{\text{DRM}}$	400	600	800	V
RMS on-state current	$I_{\text{TRMS}}$	300			mA
Single cycle surge current (50 Hz)	$I_{\text{SM}(I)}$	3			A
Max. power dissipation	$P_{\text{tot}}$	600			mW

## Characteristics

at  $T_j = 25\text{ °C}$ , unless otherwise specified.

### Input Circuit

Parameter	Symbol	Values			Unit
		min.	typ.	max.	
Forward Voltage, $I_F = 10\text{ mA}$	$V_F$	-	1.1	1.35	V
Reverse current, $V_R = 6\text{ V}$	$I_R$	-	-	10	$\mu\text{A}$
Thermal resistance 1) junction - ambient	$R_{thJA}$	-	-	750	K/W

### Output Circuit

Parameter	Symbol	Values			Unit
		min.	typ.	max.	
Critical rate of rise of off-state voltage $V_D = 0.67 V_{DRM}$ $T_j = 25\text{ °C}$ $T_j = 80\text{ °C}$	$dv/dt_{cr}$	10 5	- -	- -	kV/ $\mu\text{s}$
Critical rate of rise of voltage at current commutation $V_D = 0.67 V_{DRM}$ , $di/dt_{crq} \leq 15\text{ A/ms}$ $T_j = 25\text{ °C}$ $T_j = 80\text{ °C}$	$dv/dt_{crq}$	10 5	- -	- -	
Critical rate of rise of on-state current	$dI/dt_{cr}$	8	-	-	A/ $\mu\text{s}$
Pulse current $t_p = 5\text{ }\mu\text{s}$ , $f = 100$ , $di_p/dt = 8\text{ A}/\mu\text{s}$	$I_p$	-	-	2	A
On-state voltage, $I_T = 300\text{ mA}$	$V_T$	-	-	2.3	V
Reverse current, $V_{DRM}$ $T_j = 25\text{ °C}$ $T_j = 80\text{ °C}$	$I_D$	- -	7 12	30 100	$\mu\text{A}$
Holdin current, $V_D = 10\text{ V}$	$I_H$	-	80	500	
Thermal resistance 2) junction - ambient	$R_{thJA}$	-	-	125	K/W

**Response Characteristics**  
at  $T_j = 25\text{ }^\circ\text{C}$ , unless otherwise specified.

Parameter	Symbol	Values			Unit
		min.	typ.	max.	
Trigger current 1 $V_D = 6\text{ V}$  type H type M	$I_{FT1}$	0.4 0.4	- -	2.0 3.0	mA
Trigger current 2 $V_{op} = 220\text{ V}$ , $f = 50\text{ Hz}$ , $T_j = 100\text{ }^\circ\text{C}$ $t_{pF} > 10\text{ ms}$  type H type M	$I_{FT2}$	- -	- -	6.0 9.0	
Trigger current temperature gradient	$\Delta I_{FT1}/\Delta T_j$ $\Delta I_{FT2}/\Delta T_j$	-	7	14	$\mu\text{A/K}$
Inhibit voltage, $I_F = I_{FT1}$	$V_{DINH}$	-	8	12	V
Inhibit voltage temperature gradient	$V_D$	-	- 20	-	mV/K
Off-state current in inhibit state $I_F = I_{FT1}$ ; $V_{DRM}$	$I_{DINH}$	7	50	200	$\mu\text{A}$
Capacitance between input and output circuit $V_R = 0$ , $f = 1\text{ kHz}$	$C_{IO}$	-	-	2.0	pF

- 1) Static air, SITAC soldered in pcb or base plate.
- 2) Test AC voltage in acc. with DIN 57883, June 1980.
- 3) The SITAC zero voltage switch can be triggered only in the hatched area below the  $T_j$  curves
- 4) The SITAC switch is soldered in pcb or base plate.
- 5) Thermocouple measurement has to be performed potentially separated to A1 and A2. The measuring junction should be as near as possible at the case.

**Package Outline**

**P-DIP-6**

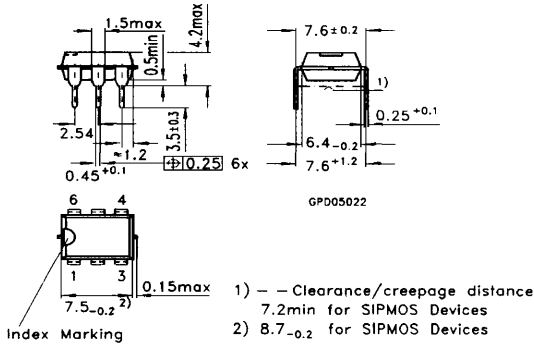

**Option 6**

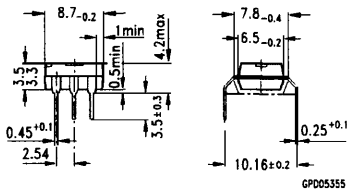

--- Clearance-/creepage distance 8.0 min.

**Option 7**

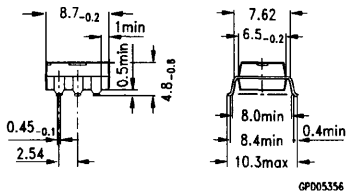

--- Clearance-/creepage distance 8.0 min.

Dimensions in mm

Clearance and creepage distances must be taken into account for the solder powl design.

### Characteristics

at  $T_j = 25^\circ\text{C}$ , unless otherwise specified.

#### Typical input characteristics

$$I_F = f(V_F)$$

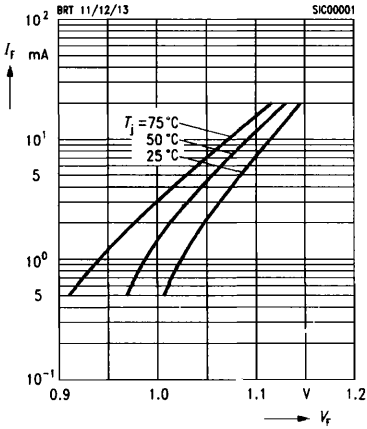

#### Typical output characteristics

$$I_T = f(V_T)$$

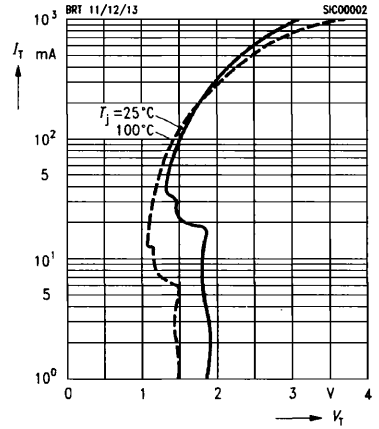

#### Current reduction $I_{TRMS} = f(T_A)$

$$R_{thJA} = 125 \text{ K/W } ^3)$$

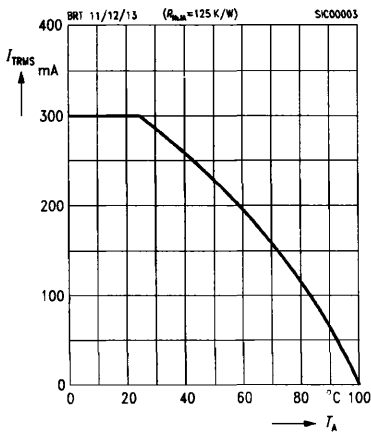

#### Current reduction $I_{TRMS} = f(T_{PIN5})$

$$R_{thJPIN5} = 16,5 \text{ K/W } ^4)$$

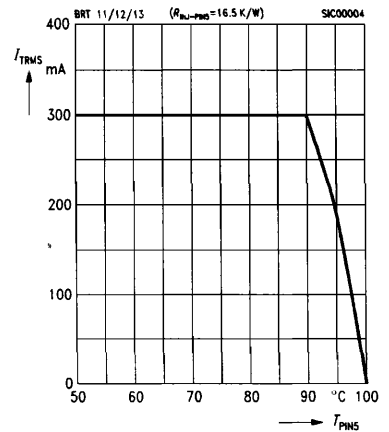

Typ trigger delay time  $t_{gd} = f(I_f / I_{FT25^\circ C})$   
 $V_D = 200 V$

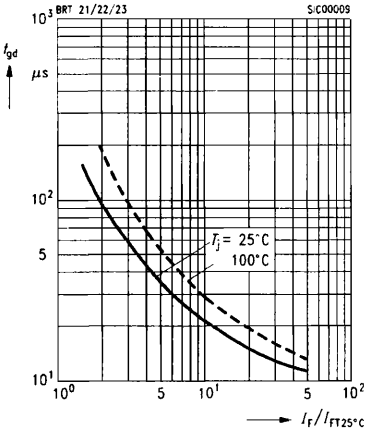

Typ. inhibit current  $I_{DINH} = f(I_f / I_{FT25^\circ C})$   
 $V_D = 800 V$

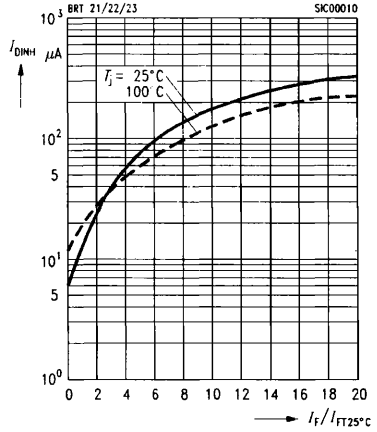

Power dissipation  $P_{tot} = f(I_{TRMS})$   
 for 40 ... 60 Hz line operation

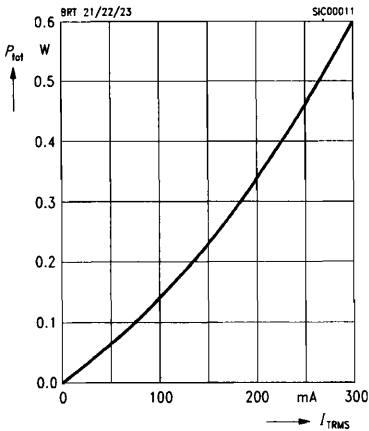

Typ. static inhibit voltage limit 2)  
 $V_{DINHmin} = f(I_f / I_{FT25^\circ C})$ , parameter:  $T_j$

