



16 x 16-BIT PARALLEL CMOS MULTIPLIER-ACCUMULATOR

IDT7210L
IDT7243L

FEATURES:

- 16 x 16-bit parallel multiplier-accumulator with selectable accumulation and subtraction
- High-speed: 35ns multiply-accumulate time
- IDT7210 features selectable accumulation, subtraction, rounding and preloading with 35-bit result
- IDT7243 features selectable accumulation, subtraction and rounding with 19-bit result
- IDT7210 is pin and functionally compatible with the TRW TDC1010J
- IDT7243 is pin and functionally compatible with the TRW TDC1043
- Both devices perform subtraction and double precision addition and multiplication
- Produced using advanced CEMOS™ high-performance technology
- Low power consumption (less than 250mW typical) – less than 1/10 the power of compatible bipolar and 1/7 the power of NMOS designs
- Input and output directly TTL-compatible
- Single 5V supply
- Available in plastic and topbraze DIP, SHRINK-DIP, LCC, Fine-Pitch LCC, PLCC, Flatpack and Pin Grid Array
- Military product compliant to MIL-STD-883, Class B

DESCRIPTION:

The IDT7210/7243 are high-speed, low-power 16 x 16-bit parallel multiplier-accumulators that are ideally suited for real-time digital signal processing applications. Fabricated using CEMOS silicon gate technology, these devices offer a very low-power alternative to existing bipolar and NMOS counterparts, with only 1/7 to 1/10 the power dissipation and exceptional speed (35ns maximum) performance.

Pin and functional replacements for TRW's TDC1010J/TDC1043, the IDT7210/7243 operate from a single 5 volt supply and are compatible with standard TTL logic levels. The architecture of the IDT7210/7243 is fairly straightforward, featuring individual input and output registers with clocked D-type flip-flops, a preload capability (IDT7210 only) which enables input data to be preloaded into the output registers, Individual three-state output ports for the Extended Product (XTP) and Most Significant Product (MSP) and a Least Significant Product output (LSP) which is multiplexed with the Y input. Unlike the IDT7210, the IDT7243 does not have either a preload capability or a Least Significant Product (LSP) output accessible externally.

The X_{IN} and Y_{IN} data input registers may be specified through the use of the Two's Complement input (TC) as either a two's complement or an unsigned magnitude, yielding a full-precision 32-bit result that may be accumulated to a full 35-bit result. The three output registers – Extended Product (XTP), Most Significant Product (MSP) and Least Significant Product (LSP) – are controlled by the respective TSX, TSM and TSL input lines. The LSP output can be routed through Y_{IN} ports in the IDT7210.

Continued on Page 2

7

FUNCTIONAL BLOCK DIAGRAM

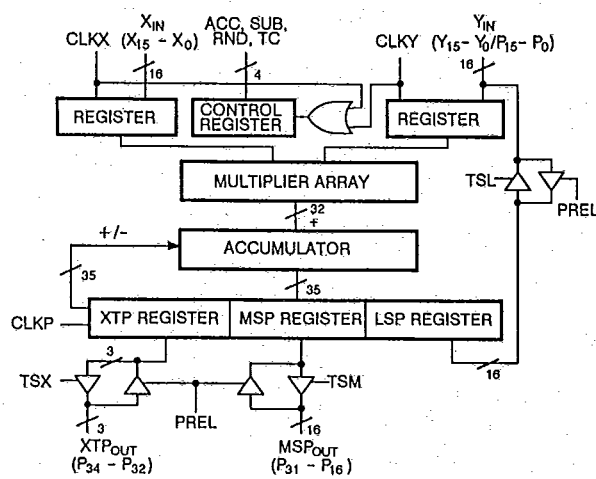

IDT7210

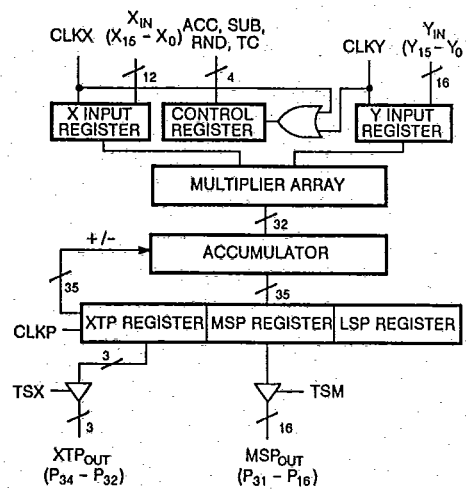

IDT7243

CEMOS is a trademark of Integrated Device Technology, Inc.

MILITARY AND COMMERCIAL TEMPERATURE RANGES

DECEMBER 1987

4825771 INTEGRATED DEVICE

97D 01873 D

IDT7210L AND IDT7243L 16 x 16-BIT
PARALLEL CMOS MULTIPLIER-ACCUMULATOR

MILITARY AND COMMERCIAL TEMPERATURE RANGES

DESCRIPTION (Continued)

The Accumulate Input (ACC) enables the device to perform either a multiply or a multiply-accumulate function. In the multiply-accumulate mode, output data can be added to or subtracted from subsequent results. When the Subtraction (SUB) input is active simultaneously with an active ACC, a subtraction can be performed. The double precision accumulated result is rounded down to either a single precision or single precision plus 3-bit extended result. In the multiply mode, the Extended Product output (XTP) is

sign extended in the two's complement mode or set to zero in the unsigned mode. The Round (RND) control rounds up the Most Significant Product (MSP) and the 3-bit Extended Product (XTP) outputs. When Preload Input (PREL) is active, all the output buffers are forced into a high-impedance state (see Preload truth table) and external data can be loaded into the output register by using the TSX, TSL and TSM signals as input controls.

T-45-07

PIN CONFIGURATIONS

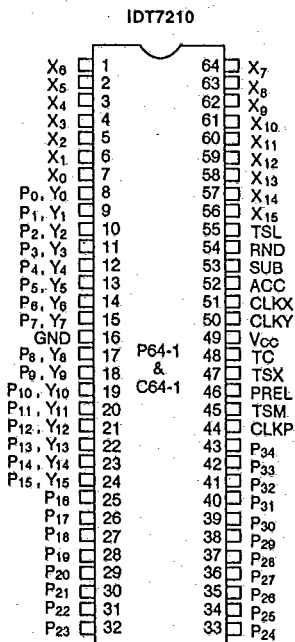

DIP TOP VIEW

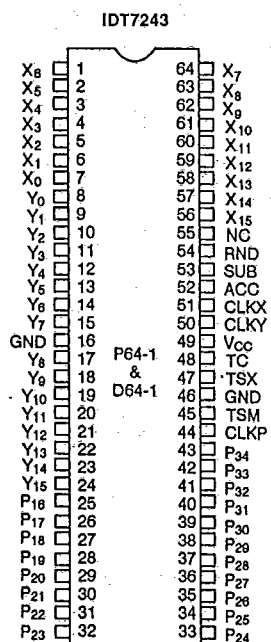

DIP TOP VIEW

4825771 INTEGRATED DEVICE

97D 01874 D

IDT7210L AND IDT7243L 16 x 16-BIT
PARALLEL CMOS MULTIPLIER-ACCUMULATOR

MILITARY AND COMMERCIAL TEMPERATURE RANGES

PIN CONFIGURATIONS

T-45-07

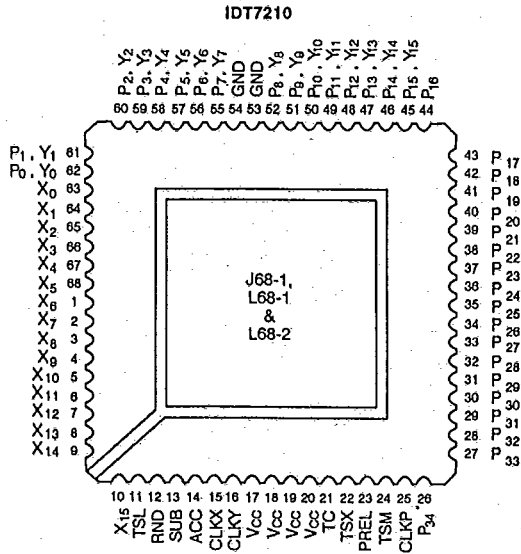

LCC/PLCC/FINE-PITCH LCC
TOP VIEW

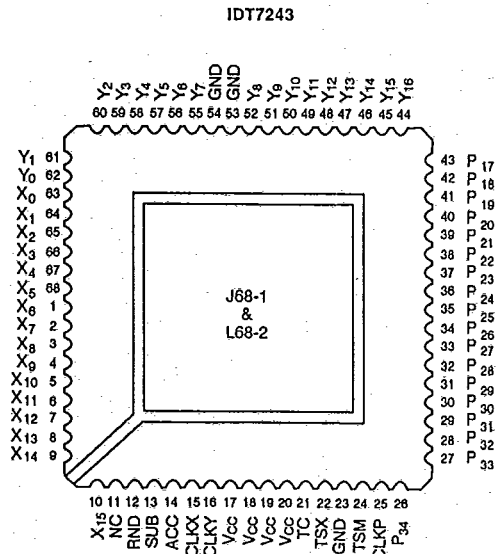

LCC/PLCC
TOP VIEW

7

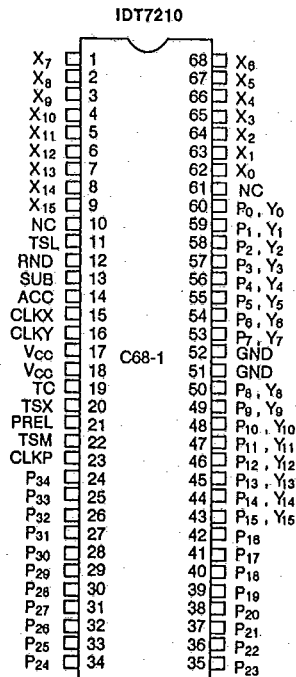

SHRINK-DIP
TOP VIEW

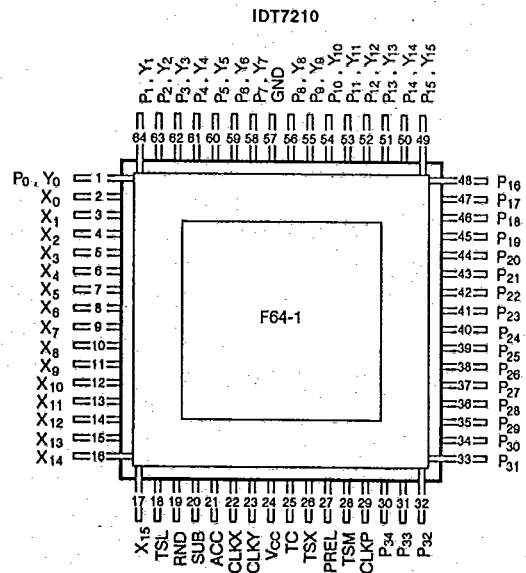

FLATPACK
TOP VIEW

4825771 INTEGRATED DEVICE

97D 01875 D

IDT7210L AND IDT7243L 16 x 16-BIT
PARALLEL CMOS MULTIPLIER-ACCUMULATOR

MILITARY AND COMMERCIAL TEMPERATURE RANGES

PIN CONFIGURATIONS (Continued)

IDT7210

T-45-07

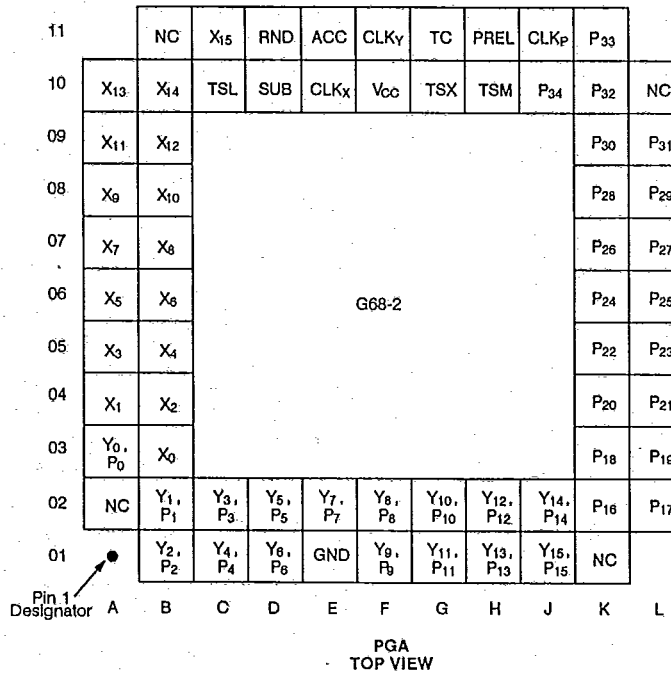

ABSOLUTE MAXIMUM RATINGS ⁽¹⁾

SYMBOL	RATING	COMMERCIAL	MILITARY	UNIT
V _{TERM}	Terminal Voltage with Respect to GND	-0.5 to +7.0	-0.5 to +7.0	V
T _A	Operating Temperature	0 to +70	-55 to +125	°C
T _{BIAS}	Temperature Under Bias	-55 to +125	-65 to +135	°C
T _{STG}	Storage Temperature	-55 to +125	-65 to +150	°C
I _{OUT}	DC Output Current	50	50	mA

NOTE:

- Stresses greater than those listed under ABSOLUTE MAXIMUM RATINGS may cause permanent damage to the device. This is a stress rating only and functional operation of the device at these or any other conditions above those indicated in the operational sections of this specification is not implied. Exposure to absolute maximum rating conditions for extended periods may affect reliability.

RECOMMENDED DC OPERATING CONDITIONS

SYMBOL	PARAMETER	MIN.	TYP.	MAX.	UNIT
V _{CCM}	Military Supply Voltage	4.5	5.0	5.5	V
V _{CC}	Commercial Supply Voltage	4.5	5.0	5.5	V
GND	Supply Voltage	0	0	0	V
V _{IH}	Input High Voltage	2.0	-	-	V
V _{IL}	Input Low Voltage	-	-	0.8	V

4825771 INTEGRATED DEVICE

97D 01876 D

IDT7210L AND IDT7243L 16 x 16-BIT
PARALLEL CMOS MULTIPLIER-ACCUMULATOR

MILITARY AND COMMERCIAL TEMPERATURE RANGES

T-45-07

DC ELECTRICAL CHARACTERISTICS – FAST

(Commercial $V_{CC} = 5V \pm 10\%$, $T_A = 0^\circ C$ to $+70^\circ C$, Military $V_{CC} = 5V \pm 10\%$, $T_A = -55^\circ C$ to $+125^\circ C$
for Commercial clocked multiply times of 20, 25, 35, 45, 55, 65, 75ns or Military 25, 30, 40, 55, 65, 75, 85ns)

SYMBOL	PARAMETER	TEST CONDITIONS	COMMERCIAL		MILITARY		UNIT		
			MIN.	TYP. ⁽¹⁾ MAX.	MIN.	TYP. ⁽¹⁾ MAX.			
I_{I1}	Input Leakage Current	$V_{CC} = \text{Max.}, V_{IN} = 0V \text{ to } V_{CC}$	-	-	10	-	-	20	μA
I_{LO}	Output Leakage Current	Hi Z, $V_{CC} = \text{Max.}, V_{OUT} = 0 \text{ to } V_{CC}$	-	-	10	-	-	20	μA
$I_{CC}^{(2)}$	Operating Power Supply Current	Outputs Open Measured at 10MHz ⁽²⁾	-	45	90	-	45	110	mA
I_{CC01}	Quiescent Power Supply Current	$V_{IN} \geq V_{IH}, V_{IN} \leq V_{IL}$	-	20	50	-	20	50	mA
I_{CC02}	Quiescent Power Supply Current	$V_{IN} \geq V_{CC} - 0.2V, V_{IN} \leq 0.2V$	-	4	10	-	4	12	mA
I_{CC}/f (2, 3)	Increase in Power Supply Current/MHz	$V_{CC} = \text{Max.}, f > 10\text{MHz}$	-	-	6	-	-	8	mA/MHz
V_{OH}	Output High Voltage	$V_{CC} = \text{Min.}, I_{OH} = -2.0\text{mA}$	2.4	-	-	2.4	-	-	V
$V_{OL}^{(4)}$	Output Low Voltage	$V_{CC} = \text{Min.}, I_{OL} = 4\text{mA}$	-	-	0.4	-	-	0.4	V

NOTES:

1. Typical implies $V_{CC} = 5V$ and $T_A = +25^\circ C$.
2. I_{CC} is measured at 10MHz and $V_{IN} = 0$ to 3V. For frequencies greater than 10MHz, the following equation is used for the commercial range: $I_{CC} = 90 + 6(f - 10)\text{mA}$, where $f =$ operating frequency in MHz. For the military range, $I_{CC} = 110 + 8(f - 10)$ where $f =$ operating frequency in MHz, $f = 1/t_{MA}$.
3. For frequencies greater than 10MHz.
4. $I_{OL} = 8\text{mA}$ for $t_{MA} = 20\text{ns}$ to 55ns.

7

DC ELECTRICAL CHARACTERISTICS – SLOW

(Commercial $V_{CC} = 5V \pm 10\%$, $T_A = 0^\circ C$ to $+70^\circ C$, Military $V_{CC} = 5V \pm 10\%$, $T_A = -55^\circ C$ to $+125^\circ C$
for Commercial clocked multiply times of 100, 165ns or Military, 120, 200ns)

SYMBOL	PARAMETER	TEST CONDITIONS	COMMERCIAL		MILITARY		UNIT		
			MIN.	TYP. ⁽¹⁾ MAX.	MIN.	TYP. ⁽¹⁾ MAX.			
I_{I1}	Input Leakage Current	$V_{CC} = \text{Max.}, V_{IN} = 0V \text{ to } V_{CC}$	-	-	2	-	-	10	μA
I_{LO}	Output Leakage Current	Hi Z, $V_{CC} = \text{Max.}, V_{OUT} = 0 \text{ to } V_{CC}$	-	-	2	-	-	10	μA
$I_{CC}^{(2)}$	Operating Power Supply Current	Outputs Open Measured at 10MHz ⁽²⁾	-	35	70	-	35	90	mA
I_{CC01}	Quiescent Power Supply Current	$V_{IN} \geq V_{IH}, V_{IN} \leq V_{IL}$	-	10	30	-	10	30	mA
I_{CC02}	Quiescent Power Supply Current	$V_{IN} \geq V_{CC} - 0.2V, V_{IN} \leq 0.2V$	-	0.1	1.0	-	0.1	2.0	mA
I_{CC}/f (2, 3)	Increase in Power Supply Current/MHz	$V_{CC} = \text{Max.}, f > 10\text{MHz}$	-	-	5	-	-	7	mA/MHz
V_{OH}	Output High Voltage	$V_{CC} = \text{Min.}, I_{OH} = -2.0\text{mA}$	2.4	-	-	2.4	-	-	V
V_{OL}	Output Low Voltage	$V_{CC} = \text{Min.}, I_{OL} = 4\text{mA}$	-	-	0.4	-	-	0.4	V

NOTES:

1. Typical implies $V_{CC} = 5V$ and $T_A = +25^\circ C$.
2. I_{CC} is measured at 10MHz and $V_{IN} = 0$ to 3V. For frequencies greater than 10MHz, the following equation is used for the commercial range: $I_{CC} = 70 + 5(f - 10)\text{mA}$, where $f =$ operating frequency in MHz. For the military range, $I_{CC} = 90 + 7(f - 10)$ where $f =$ operating frequency in MHz, $f = 1/t_{MA}$.
3. For frequencies greater than 10MHz.

4825771 INTEGRATED DEVICE

97D 01877 D

IDT7210L AND IDT7243L 16 x 16-BIT
PARALLEL CMOS MULTIPLIER-ACCUMULATOR

MILITARY AND COMMERCIAL TEMPERATURE RANGES

AC ELECTRICAL CHARACTERISTICS COMMERCIAL (V_{CC} = 5V ±10%, T_A = 0°C to +70°C)

T-45-07

SYMBOL	PARAMETER	7210L35 MIN. MAX.	7210L45 7243L45 MIN. MAX.	7210L55 7243L55 MIN. MAX.	7210L65 7243L65 MIN. MAX.	7210L75 7243L75 MIN. MAX.	7210L100 7243L100 MIN. MAX.	7210L160 7243L160 MIN. MAX.	UNIT
t _{MA} (2)	Multiply-Accumulate Time	- 35	- 45	- 55	- 65	- 75	- 100	- 165	ns
t _D (2)	Output Delay	- 25	- 25	- 30	- 35	- 35	- 35	- 40	ns
t _{ENA} (3)	3-State Enable Time(1)	- 25	- 25	- 30	- 30	- 35	- 35	- 40	ns
t _{DIS} (3)	3-State Disable Time(1)	- 25	- 25	- 30	- 30	- 35	- 35	- 40	ns
t _S	Input Register Set-up Time	12 - 15	- 20 -	- 25 -	- 25 -	- 25 -	- 30 -	- 30 -	ns
t _H	Input Register Hold Time	3 - 3	- 3 -	- 3 -	- 3 -	- 3 -	- 0 -	- 0 -	ns
t _{PW}	Clock Pulse Width	10 - 15	- 20 -	- 25 -	- 25 -	- 25 -	- 25 -	- 25 -	ns

NOTES:

1. Transition is measured ±500mV from steady state voltage with loading specified in Figure 2.
2. See Test Load Figure 1.
3. See Test Load Figure 2.

AC ELECTRICAL CHARACTERISTICS MILITARY (V_{CC} = 5V ±10%, T_A = -55°C to +125°C)

SYMBOL	PARAMETER	7210L40 MIN. MAX.	7210L55 7243L55 MIN. MAX.	7210L65 7243L65 MIN. MAX.	7210L75 7243L75 MIN. MAX.	7210L85 7243L85 MIN. MAX.	7210L120 7243L120 MIN. MAX.	7210L200 7243L200 MIN. MAX.	UNIT
t _{MA} (2)	Multiply-Accumulate Time	- 40	- 55	- 65	- 75	- 85	- 120	- 200	ns
t _D (2)	Output Delay	- 25	- 30	- 35	- 35	- 35	- 40	- 45	ns
t _{ENA} (3)	3 State Enable Time(1)	- 25	- 30	- 30	- 35	- 35	- 40	- 45	ns
t _{DIS} (3)	3 State Disable Time(1)	- 25	- 30	- 30	- 30	- 35	- 40	- 45	ns
t _S	Input Register Set-up Time	15 - 20	- 25 -	- 25 -	- 25 -	- 25 -	- 30 -	- 30 -	ns
t _H	Input Register Hold Time	3 - 3	- 3 -	- 3 -	- 3 -	- 3 -	- 0 -	- 0 -	ns
t _{PW}	Clock Pulse Width	15 - 20	- 25 -	- 25 -	- 25 -	- 30 -	- 30 -	- 30 -	ns

NOTES:

1. Transition is measured ±500mV from steady state voltage with loading specified in Figure 2.
2. See Test Load Figure 1.
3. See Test Load Figure 2.

AC TEST CONDITIONS

Input Pulse Levels	GND to 3.0V
Input Rise/Fall Times	3ns
Input Timing Reference Levels	1.5V
Output Reference Levels	1.5V
Output Load	See Figures 1 and 2

CAPACITANCE (T_A = +25°C, f = 1.0MHz)

SYMBOL	PARAMETER(1)	CONDITIONS	MAX.	UNIT
C _{IN}	Input Capacitance	V _{IN} = 0V	10	pF
C _{OUT}	Output Capacitance	V _{OUT} = 0V	12	pF

NOTE:

1. This parameter is sampled and not 100% tested.

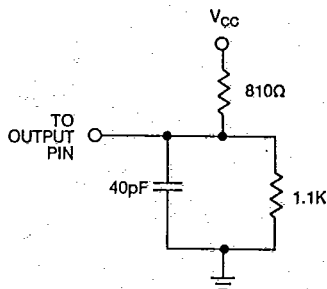

Figure 1. AC Output Test Load

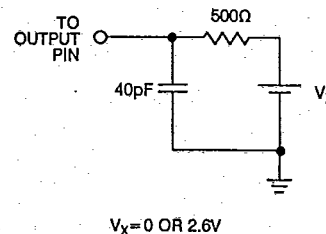

Figure 2. Output Three-State Delay Load

4825771 INTEGRATED DEVICE

97D 01878 D

T-45-07

IDT7210L AND IDT7243L 16 x 16-BIT
PARALLEL CMOS MULTIPLIER-ACCUMULATOR

MILITARY AND COMMERCIAL TEMPERATURE RANGES

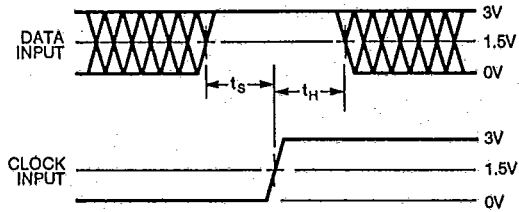

Figure 3. Set-Up and Hold Time

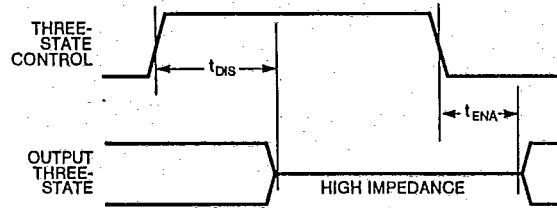

Figure 4. Three-State Control Timing Diagram

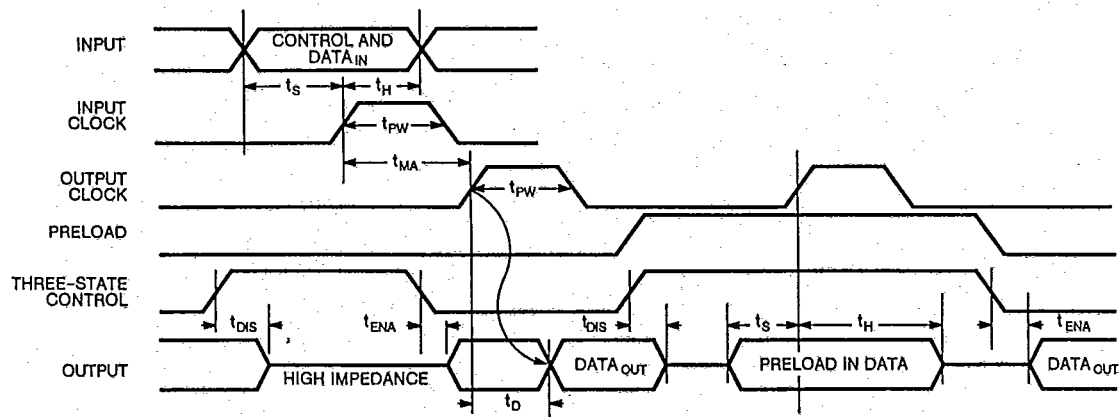

Figure 5. Timing Diagram

7

4825771 INTEGRATED DEVICE

97D 01879

D

T-45-07

IDT7210L AND IDT7243L 16 x 16-BIT
PARALLEL CMOS MULTIPLIER-ACCUMULATOR

MILITARY AND COMMERCIAL TEMPERATURE RANGES

SIGNAL DESCRIPTIONS:**INPUTS:**

X_{IN} ($X_{15} - X_0$)
Multiplier Data Inputs

Y_{IN} ($Y_{15} - Y_0$)
Multiplier Data Inputs

INPUT CLOCKS:

CLKX, CLKY
Input data is loaded on the rising edge of these clocks.

CONTROLS:

ACC (Accumulate)
When ACC is high, the contents of the XTP, MSP and LSP registers are added to or subtracted from the multiplier output. When ACC is low, the device acts as a simple multiplier with no accumulation being performed and the next product generated will be stored directly into the output registers. The ACC signal is loaded on the rising edge of the CLKX or CLKY and must be valid for the duration of the data input.

SUB (Subtract)
When the ACC and SUB signals are both high, the contents of the output register are subtracted from the next product generated and the difference is stored back into the output registers at the rising edge of the next CLKP. When ACC is high and SUB is low, an addition instead of a subtraction is performed. Like the ACC signal, the SUB signal is loaded into the SUB register at the rising edge of either CLKX or CLKY and must be valid over the same period as the input data is valid. When the ACC is low, SUB acts as a "don't care" input.

TC (Two's Complement)
When the TC Control is high, it makes both the X and Y input two's complement inputs. When the TC Control is low, it makes both inputs, X and Y, unsigned magnitude inputs.

RND (Round)
A high level at this input adds a "1" to the most significant bit of the LSP to round up the XTP and MSP data. RND, like ACC and SUB, is loaded on the rising edge of either CLKX or CLKY and must be valid for the duration of the input data.

PREL (Preload) (IDT7210 only)
When the PREL input is high, the output is driven to a high impedance state. When the TSX, TSL and TSM inputs are also high, the contents of the output register can be preset to the preload data applied to the output pins at the rising edge of CLKP. The PREL, TSM, TSL and TSX inputs must be valid over the same period that the preload input is valid.

Y_{IN} /LSP Output—(LSP output, IDT7210 only)
Shares functions between 16-bit data input (Y_{IN}) and the least significant product output (LSP).

TSX, TSL, TSM (Three-State Output Controls)

The XTP, MSP and LSP registers are controlled by direct non-registered control signals. These output drivers are at high impedance (disabled) when control signals TSX, TSM and TSL are high and are enabled when TSX, TSM and TSL are low.

OUTPUT CLOCK:

CLKP
Output data is loaded into the output register on the rising edge of this clock.

OUTPUTS:

XTP ($P_{34} - P_{32}$)
Extended Product Output (3-bits)

MSP ($P_{31} - P_{16}$)
Most Significant Product

LSP ($P_{15} - P_0$)
Least Significant Product (IDT7210 only), shared with Y_{IN} input.

NOTES ON TWO'S COMPLEMENT FORMATS:

- In two's complement notation, the location of the binary point that signifies the separation of the fractional and Integer fields is just after the sign, between the sign bit (-2^0) and the next significant bit for the multiplier inputs. This same format is carried over to the output format, except that the extended significance of the Integer field is provided to extend the utility of the accumulator. In the case of the output notation, the output binary point is located between the 2^0 and 2^{-1} bit positions. The location of the binary point is arbitrary, as long as there is consistency with both the input and output formats. The number field can be considered entirely integer with the binary point just to the right of the least significant bit for the input, product and the accumulated sum.
- When in the non-accumulating mode, the first four bits (P_{34} to P_{31}) will all indicate the sign of the product. Additionally, the P_{30} term will also indicate the sign with one exception, when multiplying -1×-1 . With the additional bits that are available in this multiplier, the -1×-1 is a valid operation that yields a $+1$ product.
- In operations that require the accumulation of single products or sum of products, there is no change in format. To allow for a valid summation beyond that available for a single multiplication product, three additional significant bits (guard bits) are provided. This is the same as if the product was accumulated off-chip in a separate 35-bit wide adder. Taking the sign at the most significant bit position will guarantee that the largest number field will be used. When the accumulated sum only occupies the right hand portion of the accumulator, the sign will be extended into the lesser significant bit positions.

4825771 INTEGRATED DEVICE

97D 01880 D

IDT7210L AND IDT7243L 16 x 16-BIT
PARALLEL CMOS MULTIPLIER-ACCUMULATOR

MILITARY AND COMMERCIAL TEMPERATURE RANGES

PRELOAD TRUTH TABLE (IDT7210 only)

T-45-07

PREL	TSX	TSM	TSL	XTP	MSP	LSP
0	0	0	0	Q	Q	Q
0	0	0	1	Q	Q	HI Z
0	0	1	0	Q	HI Z	Q
0	0	1	1	Q	HI Z	HI Z
0	1	0	0	HI Z	Q	Q
0	1	0	1	HI Z	Q	HI Z
0	1	1	0	HI Z	HI Z	Q
0	1	1	1	HI Z	HI Z	HI Z
1	0	0	0	HI Z	HI Z	HI Z
1	0	0	1	HI Z	HI Z	PL
1	0	1	0	HI Z	PL	HI Z
1	0	1	1	HI Z	PL	PL
1	1	0	0	PL	HI Z	HI Z
1	1	0	1	PL	HI Z	PL
1	1	1	0	PL	PL	HI Z
1	1	1	1	PL	PL	PL

NOTES:

- HI Z = Output buffers at high impedance (output disabled).
- Q = Output buffers at low impedance. Contents of output register will be transferred to output pins.
- PL = Output buffers at high impedance or output disabled. Preload data supplied externally at output pins will be loaded into the output register at the rising edge of CLKP.

7

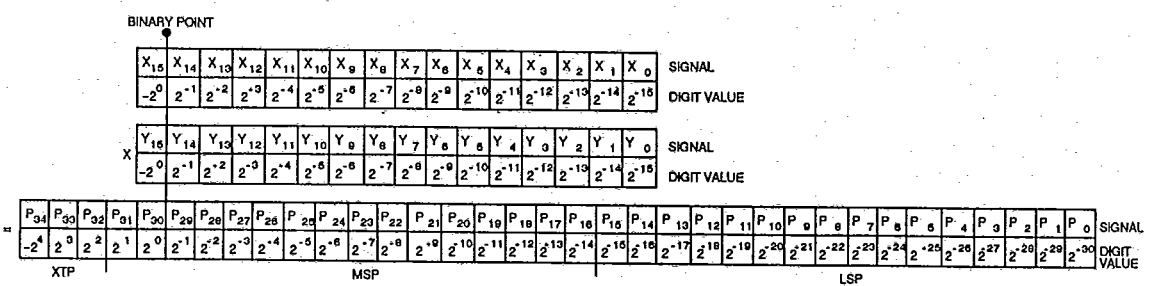

Figure 6. Fractional Two's Complement Notation

4825771 INTEGRATED DEVICE

97D 01881 D

IDT7210L AND IDT7243L 16 x 16-BIT
PARALLEL CMOS MULTIPLIER-ACCUMULATOR

MILITARY AND COMMERCIAL TEMPERATURE RANGES

T-45-07

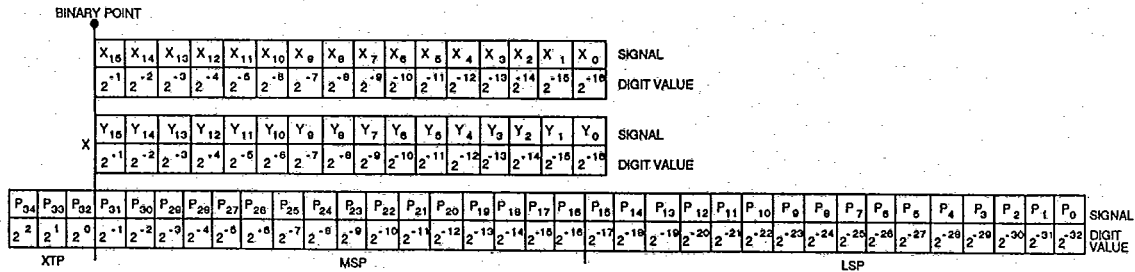

Figure 7. Fractional Unsigned Magnitude Notation

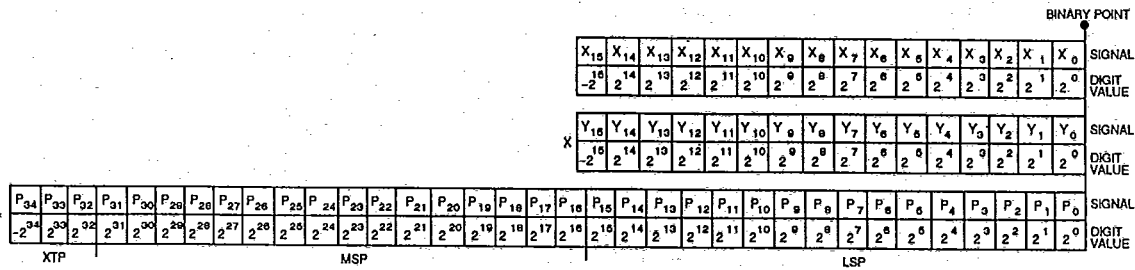

Figure 8. Integer Two's Complement Notation

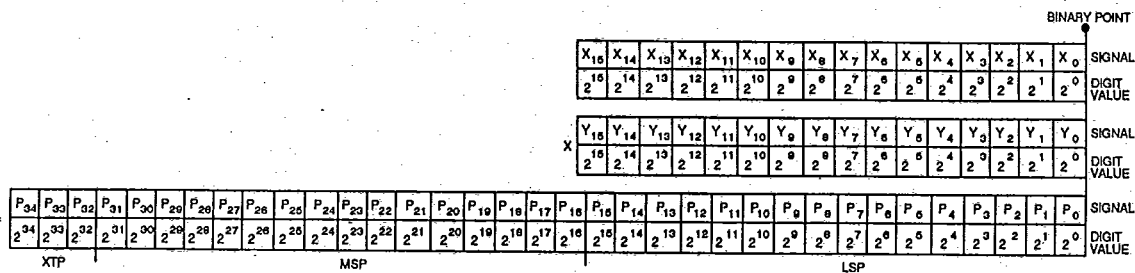

Figure 9. Integer Unsigned Magnitude Notation

4825771 INTEGRATED DEVICE

97D 01882 D

IDT7210L AND IDT7243L 16 x 16-BIT
PARALLEL CMOS MULTIPLIER-ACCUMULATOR

MILITARY AND COMMERCIAL TEMPERATURE RANGES

ORDERING INFORMATION

T-45-07

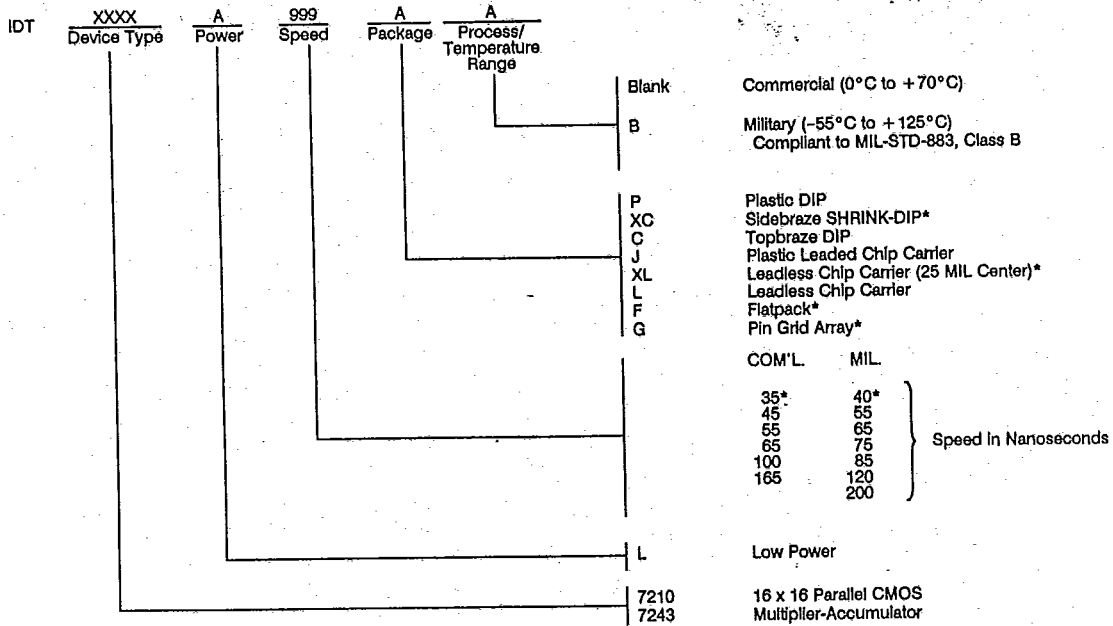

* IDT7210 only.