

Position	DIM A	DIM B
02	6.60	2.54
03	9.14	5.08
04	11.68	7.62
05	14.22	10.16
06	16.76	12.70
07	19.30	15.24
08	21.80	17.78
09	24.38	20.32
10	26.92	22.88
12	32.00	27.94

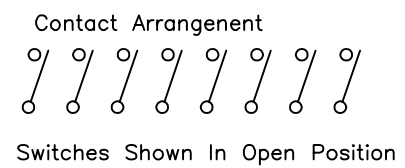
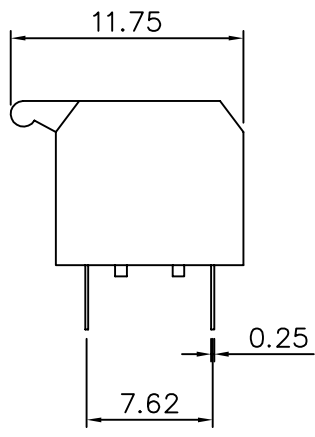
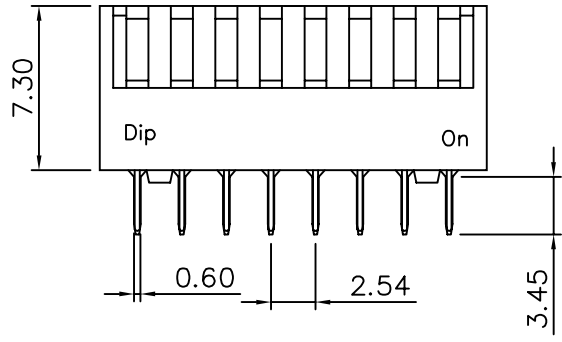

AUK A NUMBER OF AUK GROUP
太聯事業股份有限公司
 AUK CONTRACTORS CO., LTD.

DRAWING No.
 SW02P

APPROVED BY
 MEI
 CHECKED BY
 RAN
 DRAWING BY
 HZF

UNLESS OTHERWISE SPECIFIED TOLERANCES ARE
 .X ±0.38
 .XX ±0.12
 .XXX ±0.05

SCALE NONE REV. A UNIT mm

AREA	REVISIONS	CHK	DATE