

Power management (dual digital transistors)

EMC5 / UMC5N / FMC5A

●Features

- 1) Both the DTA143X chip and DTC144E chip in a EMT or UMT or SMT package.
- 2) Ideal for power switch circuits.
- 3) Mounting cost and area can be cut in half.

●Structure

Epitaxial planar type
NPN / PNP silicon transistor (Built-in resistor type.)

●Equivalent circuit

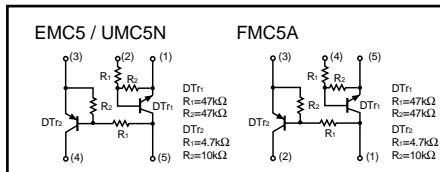

●Packaging specifications

Type	Package	Taping		
	Code	T2R	TR	T148
	Basic ordering unit (pieces)	8000	3000	3000
EMC5	○	—	—	—
UMC5N	—	○	—	—
FMC5A	—	—	—	○

●External dimensions (Units : mm)

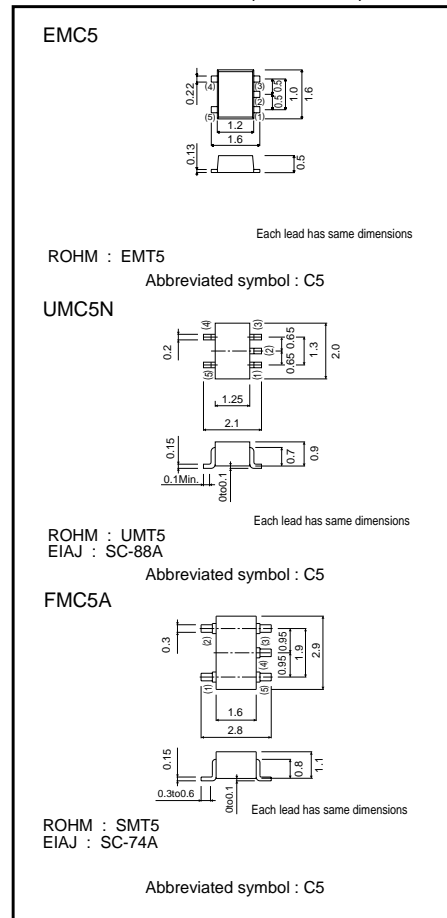

Transistors

● Absolute maximum ratings (Ta = 25°C)

Parameter	Symbol	Limits		Unit
		DTr1 (NPN)	DTr2 (PNP)	
Supply voltage	V _{CC}	50	-50	V
Input voltage	V _{IN}	40	-20	V
		-10	7	
Output current	I _O	30	-100	mA
	I _{C (Max.)}	100	-100	
Power dissipation	EMC5, UMC5N	150 (TOTAL)		mW *1
	FMC5A	300 (TOTAL)		mW *2
Junction temperature	T _j	150		°C
Storage temperature	T _{stg}	-55→+150		°C

*1 120mW per element must not be exceeded.

*2 200mW per element must not be exceeded.

● Electrical characteristics (Ta = 25°C)

DTr1

Parameter	Symbol	Min.	Typ.	Max.	Unit	Conditions
Input voltage	V _{I (off)}	-	-	0.5	V	V _{CC} =5V, I _O =100μA
	V _{I (on)}	3	-	-		V _O =0.3V, I _O =2mA
Output voltage	V _{O (on)}	-	0.1	0.3	V	I _O =10mA, I _I =0.5mA
Input current	I _I	-	-	0.18	mA	V _I =5V
Output current	I _{O (off)}	-	-	0.5	μA	V _{CC} =50V, V _I =0V
DC current gain	G _I	68	-	-	-	V _O =5V, I _O =5mA
Transition frequency	f _T	-	250	-	MHz	V _{CE} =10mA, I _E =-5mA, f=100MHz *
Input resistance	R ₁	32.9	47	61.1	kΩ	-
Resistance ratio	R ₂ /R ₁	0.8	1	1.2	-	-

* Transition frequency of the device

DTr2

Parameter	Symbol	Min.	Typ.	Max.	Unit	Conditions
Input voltage	V _{I (off)}	-	-	-0.3	V	V _{CC} =-5V, I _O =-100μA
	V _{I (on)}	-2.5	-	-		V _O =-0.3V, I _O =-20mA
Output voltage	V _{O (on)}	-	-0.1	-0.3	V	I _O =-10mA, I _I =-0.5mA
Input current	I _I	-	-	-1.8	mA	V _I =-5V
Output current	I _{O (off)}	-	-	-0.5	μA	V _{CC} =-50V, V _I =0V
DC current gain	G _I	30	-	-	-	V _O =-5V, I _O =-10mA
Transition frequency	f _T	-	250	-	MHz	V _{CE} =-10mA, I _E =5mA, f=100MHz *
Input resistance	R ₁	3.29	1.7	6.11	kΩ	-
Resistance ratio	R ₂ /R ₁	1.7	2.1	2.6	-	-

* Transition frequency of the device

Transistors

●Electrical characteristic curves

DTr1 (NPN)

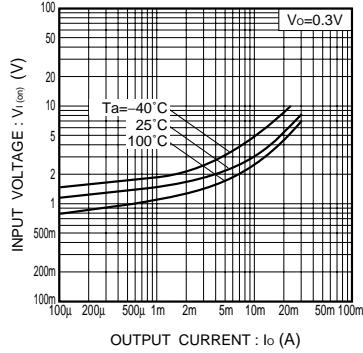

Fig.1 Input voltage vs. output current (ON characteristics)

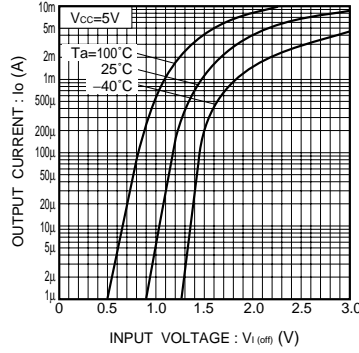

Fig.2 Output current vs. input voltage (OFF characteristics)

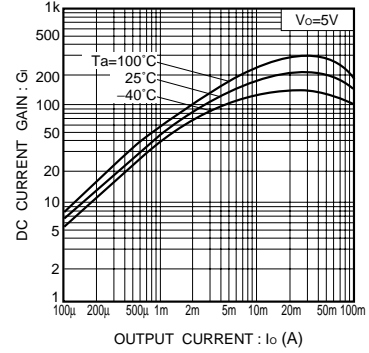

Fig.3 DC current gain vs. output current

DTr2 (PNP)

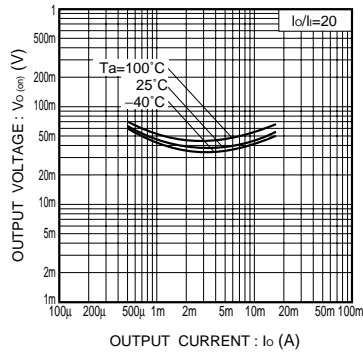

Fig.4 Output voltage vs. output current

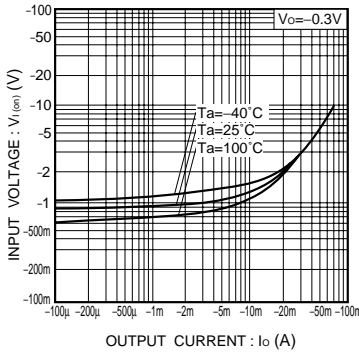

Fig.5 Input voltage vs. output current (ON characteristics)

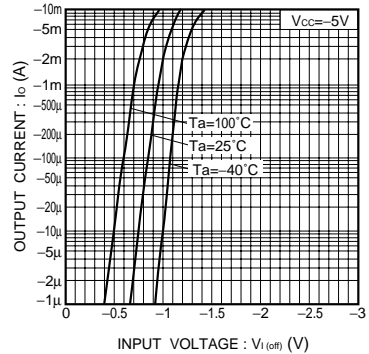

Fig.6 Output current vs. input voltage (OFF characteristics)

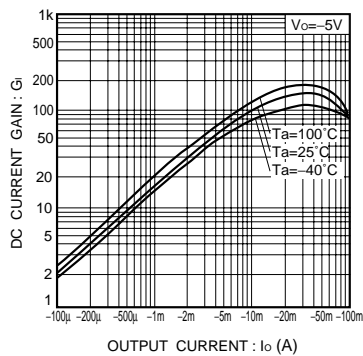

Fig.7 DC current gain vs. output current

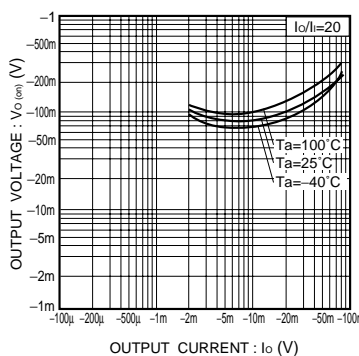

Fig.8 Output voltage vs. output current

Mouser Electronics

Authorized Distributor

Click to View Pricing, Inventory, Delivery & Lifecycle Information:

[ROHM Semiconductor:](#)

[UMC5NTR](#) [FMC5AT148](#)