

# SP9687

## ULTRA FAST COMPARATOR

The SP9687 is an ultra-fast dual comparator manufactured with a high performance bipolar process which makes possible very short propagation delays (2.2ns typ.). The circuit has differential inputs and complementary outputs fully compatible with ECL logic levels. The output current capability is adequate for driving 50Ω terminated transmission lines. The high resolution available makes the device ideally suited to analog-to-digital signal processing applications.

A latch function is provided to allow the comparator to be operated in the follow-hold or sample-hold mode. The latch function inputs are intended to be driven from the complementary outputs of a standard ECL gate. If LE is high, and  $\overline{LE}$  is low, the comparator latch is transparent. When LE is driven low and  $\overline{LE}$  high, the outputs are latched, see Fig.3. If the latch function is not used, LE must be connected to ECL HI (or ground) and  $\overline{LE}$  to ECL LO.

The device is pin compatible with the AM687 and operates from conventional +5V and -5.2V rails.

### FEATURES

- Propagation Delay 2.2ns Typ.
- Latch Set-up Time 1ns Max.
- Complementary ECL Outputs
- 50 ohm Line Driving Capability
- Excellent Common Mode Rejection
- Supply Voltages +5V, -5.2V
- Operating Temperature Range:  
 SP9687 — -30°C to +85°C  
 SP9687AC — -55°C to +125°C
- Pin Compatible with AD9687
- Pin Compatible with AM687 — But Faster
- Comparators within each SP9687 are matched as follows:  
 Input to Output Delay Matching 200ps (typ)  
 Latch to Output Delay Matching 200ps (typ)

### ORDERING INFORMATION

- SP9687DG** (Industrial - Ceramic DIL package)  
**SP9687BB DG** (Plessey High Reliability Ceramic DIL package)  
**SP9687MP** (Industrial - Miniature Plastic package)  
**SP9687AC DG** (Military - Ceramic DIL package)

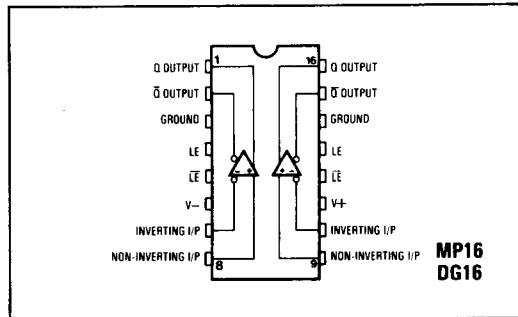

Fig.1 Pin connections

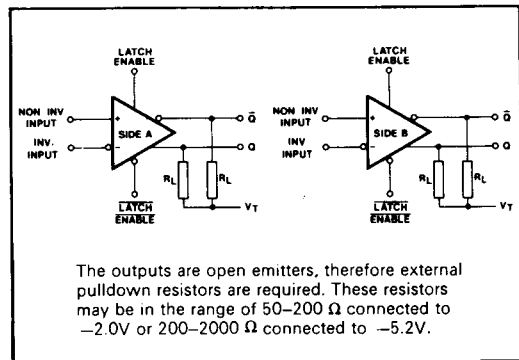

Fig.2 Functional diagram

### NOTE:

The AC version of this product conforms to MIL-STD-883C CLASS B screening and is covered by separate data which observes the change notification requirements of MIL-M-38510 and is published in the 'MIL-STD-883C CLASS B Integrated Circuit' Handbook. Please consult your nearest Plessey sales office.

**OPERATING NOTES**

**Timing diagram**

The timing diagram, Fig. 3, shows in graphic form a sequence of events in the SP9687. It should not be interpreted as 'typical' in that several parameters are multi-valued and the worst case conditions are illustrated. The top line shows two latch enable pulses, high for 'compare', and low for latch. The first pulse is used to highlight the 'compare' function, where part of the input action takes place in the compare mode. The leading edge of the input signal, here illustrated as a large amplitude, small overdrive pulse switches the comparator over after a time  $t_{pd}$ . Output Q and  $\bar{Q}$  transitions are essentially similar in timing. The input signal must occur at a time  $t_s$  before the latch falling edge, and must be maintained for a time  $t_h$  after the latch falling edge, in order to be acquired. After  $t_h$ , the output ignores the input status until the latch is again strobed. A minimum latch pulse width  $t_{pw(E)}$  is required for the strob operation, and the output transitions occur after a time  $t_{pd(E)}$ . The LE input is omitted for clarity.

**ABSOLUTE MAXIMUM RATINGS**

Positive supply voltage	6V
Negative supply voltage	-6V
Output current	30mA
Input voltage	$\pm 3V$
Differential input voltage	3.5V
Differential latch voltage	3.5V
Power dissipation	590mW
Storage temperature range	-65°C to +150°C
Junction operating temperature	<175°C
Lead temperature (soldering 60 sec)	300°C

**Thermal characteristics**

DG16	$\theta_{JA} = 110^\circ\text{C/W}$
	$\theta_{JC} = 33^\circ\text{C/W}$
LC20	$\theta_{JA} = 73^\circ\text{C/W}$
	$\theta_{JC} = 22^\circ\text{C/W}$

**ELECTRICAL CHARACTERISTICS**

**Test conditions (unless otherwise stated):**

$T_{amb} = -30^\circ\text{C}$  to  $+85^\circ\text{C}$ ;  $V_{CC} = 5.0V \pm 0.25V$ ;  $V_{EE} = -5.2V \pm 0.25V$ ;

$R_L = 50\Omega$ ;  $V_T = -2.0V$  (see Fig.2)

Characteristic	Value		Units	Conditions
	Min.	Max.		
Input offset voltage	-5	+5	mV	$R_s < 100\Omega$ 25°C
	-7	+7	mV	$R_s < 100\Omega$
Input bias current		20	$\mu\text{A}$	25°C
		30	$\mu\text{A}$	
Input offset current		5	$\mu\text{A}$	25°C
		8	$\mu\text{A}$	
Input resistance	60		k $\Omega$	25°C
Input capacitance		3	pF	25°C
Supply current $I_{EE}$		68	mA	Note 2 25°C
		75	mA	
Supply current $I_{CC}$		46	mA	Note 2 25°C
		50	mA	
Common mode range	-2.5	+2.5	V	
Output logic levels				
Output high	-0.96	-0.81	V	25°C
	-1.045	-0.875	V	$T_{amb} = \text{Min.}$
	-0.89	-0.70	V	$T_{amb} = \text{Max.}$
Output low	-1.85	-1.65	V	25°C
	-1.89	-1.65	V	$T_{amb} = \text{Min.}$
	-1.83	-1.575	V	$T_{amb} = \text{Max.}$
Min. latch set up time		1	ns	Notes 1, 3, 4 25°C
		2	ns	
Input to output delay		3	ns	Notes 1, 3 (Q and $\bar{Q}$ ) 25°C
		4	ns	
Latch to output delay		3	ns	Notes 1, 3, 4 (Q and $\bar{Q}$ ) 25°C
		4.5	ns	
Minimum latch pulse width		3	ns	Note 1 25°C
Minimum hold time		1	ns	Note 1 25°C

**NOTES**

- 1 Guaranteed but not tested.
- 2 Refers to entire package. Other data in this table applies to each half.
- 3 -100mV pulse with -10mV overdrive. See Figs 6 to 8.
- 4 Switching measurements involving the latch are particularly difficult to perform and cannot be tested in production. Circuit analysis shows that at least 95% of devices will meet these specifications.

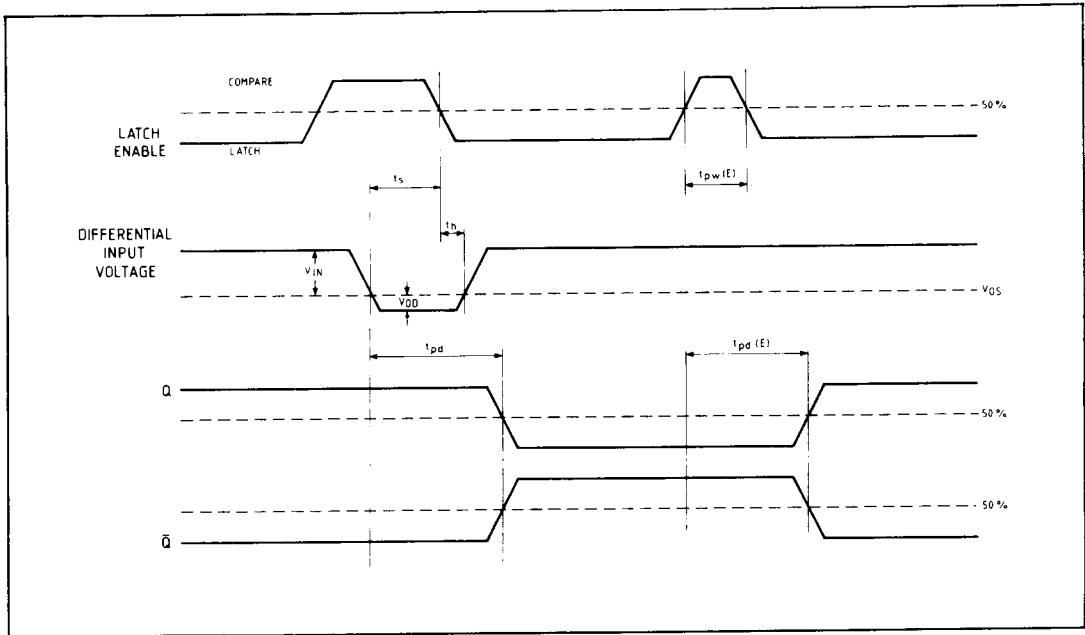

Fig.3 Timing diagram

**PERFORMANCE CURVES**

Unless otherwise specified, standard conditions for all curves are  $T_{amb} = 25^{\circ}C$ ,  $V_{CC} = 5.0V$ ,  $V_{EE} = -5.2V$

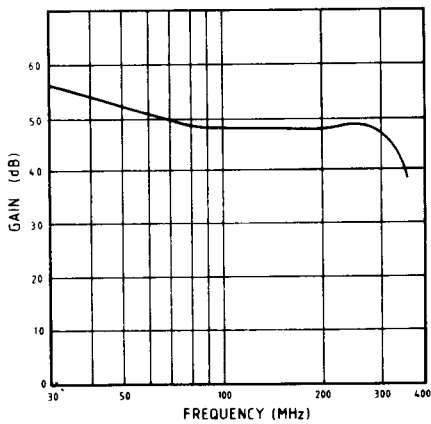

Fig.4 Open loop gain as a function of frequency

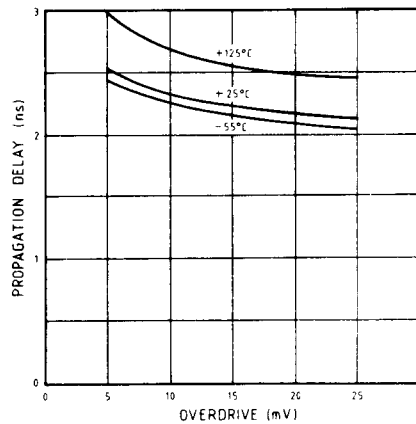

Fig.5 Propagation delay, latch to output as a function of overdrive

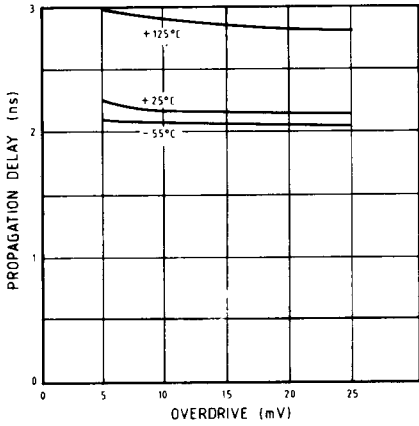

Fig.6 Propagation delay, input to output as a function of overdrive

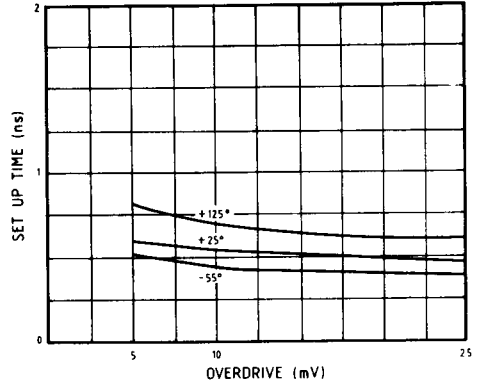

Fig.7 Set-up time as a function of temperature

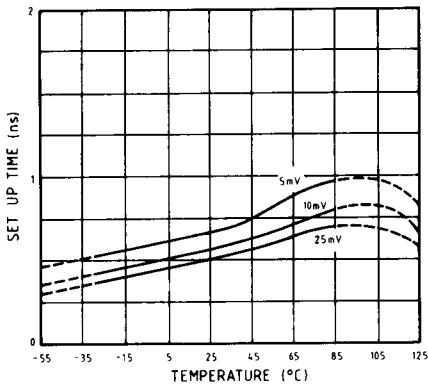

Fig.8 Set-up time as a function of input overdrive

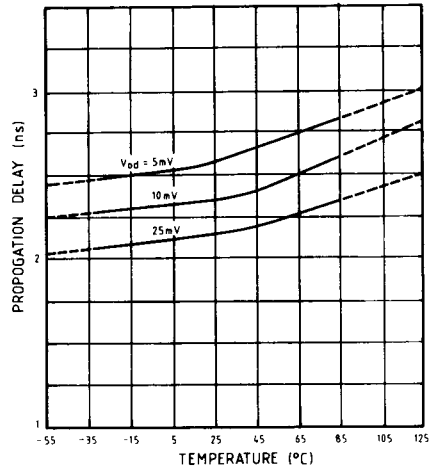

Fig.9 Propagation delay, input to output as a function of temperature

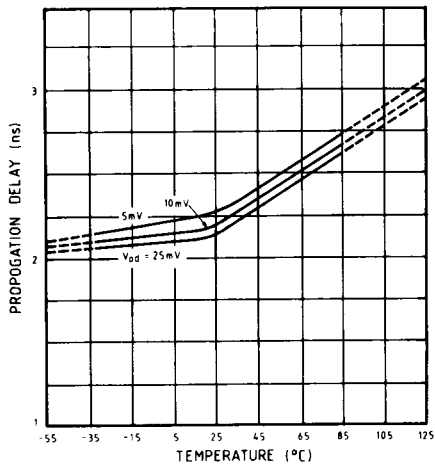

Fig.10 Propagation delay, latch to output as a function of temperature

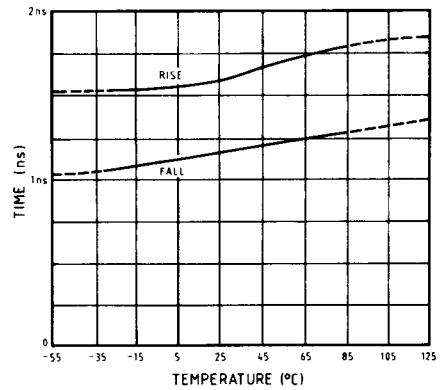

Fig.11 Output rise and fall times as a function of temperature

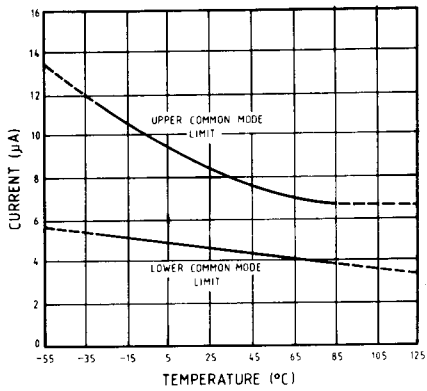

Fig.12 Input bias currents as a function of temperature

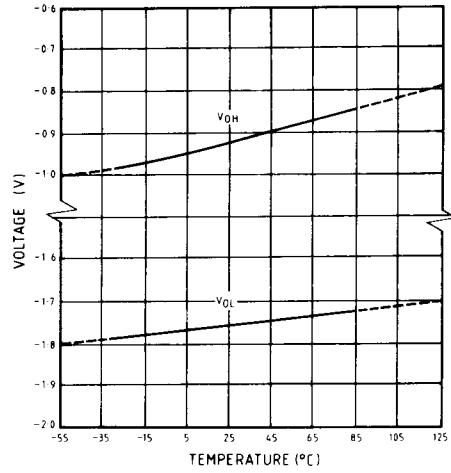

Fig.13 Output levels as a function of temperature

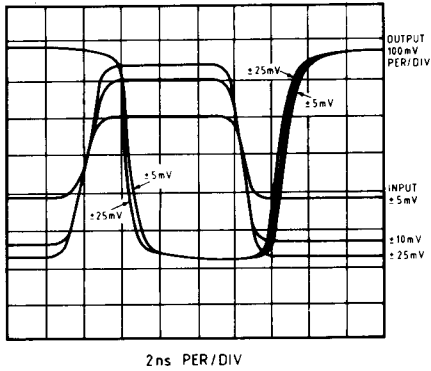

Fig.14 Response to various input signals levels