



Raychem

TE Internal #: 7364573001

Twisted Pair Cable, Spec 99M, 750VAC Voltage Rating, 22AWG

Wire Size, Operating Temperature Range -55 – 120 °C

[View on TE.com >](#)

Wire & Cable > Twisted Pair Cable



Cable Type: **Spec 99M**

Voltage Rating: **750 VAC**

Insulation Material: **Radiation-Crosslinked, Modified Polyester**

Conductor Material: **Tin-Plated Copper**

Wire Size: **22 AWG**

Features

Product Type Features

Cable Type	Spec 99M
------------	----------

Electrical Characteristics

Voltage Rating	750 VAC
----------------	---------

Body Features

Insulation Material	Radiation-Crosslinked, Modified Polyester
Conductor Material	Tin-Plated Copper

Dimensions

Wire Size	22 AWG
-----------	--------

Usage Conditions

Operating Temperature Range	-55 – 120 °C
-----------------------------	--------------

Product Compliance

[For compliance documentation, visit the product page on TE.com>](#)

EU RoHS Directive 2011/65/EU	Compliant
EU ELV Directive 2000/53/EC	Compliant
China RoHS 2 Directive MIIT Order No 32, 2016	No Restricted Materials Above Threshold
EU REACH Regulation (EC) No. 1907/2006	Current ECHA Candidate List: JUN 2020 (209)



Candidate List Declared Against: JUN 2020
(209)

Does not contain REACH SVHC

Halogen Content

Not Low Halogen - contains Br or Cl > 900 ppm.

Solder Process Capability

Not applicable for solder process capability

Product Compliance Disclaimer

This information is provided based on reasonable inquiry of our suppliers and represents our current actual knowledge based on the information they provided. This information is subject to change. The part numbers that TE has identified as EU RoHS compliant have a maximum concentration of 0.1% by weight in homogenous materials for lead, hexavalent chromium, mercury, PBB, PBDE, DBP, BBP, DEHP, DIBP, and 0.01% for cadmium, or qualify for an exemption to these limits as defined in the Annexes of Directive 2011/65/EU (RoHS2). Finished electrical and electronic equipment products will be CE marked as required by Directive 2011/65/EU. Components may not be CE marked. Additionally, the part numbers that TE has identified as EU ELV compliant have a maximum concentration of 0.1% by weight in homogenous materials for lead, hexavalent chromium, and mercury, and 0.01% for cadmium, or qualify for an exemption to these limits as defined in the Annexes of Directive 2000/53/EC (ELV). Regarding the REACH Regulation, the information TE provides on SVHC in articles for this part number is based on the latest European Chemicals Agency (ECHA) 'Guidance on requirements for substances in articles' posted at this URL: <https://echa.europa.eu/guidance-documents/guidance-on-reach>

Compatible Parts



TE Model / Part # 650074-000
D-436-36

Customers Also Bought



TE Model / Part #228311-000
HEX40-AC-00-21-A9-1-DS



TE Model / Part #A01393-000
55PC0111-28-9

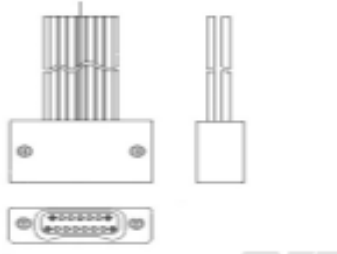

TE Model / Part #9-1589476-1
STM015SC2DX010N = WDUJALOBE



TE Model / Part #BTH1-15-08-1-ZN
BTH1-15-08-1-ZN

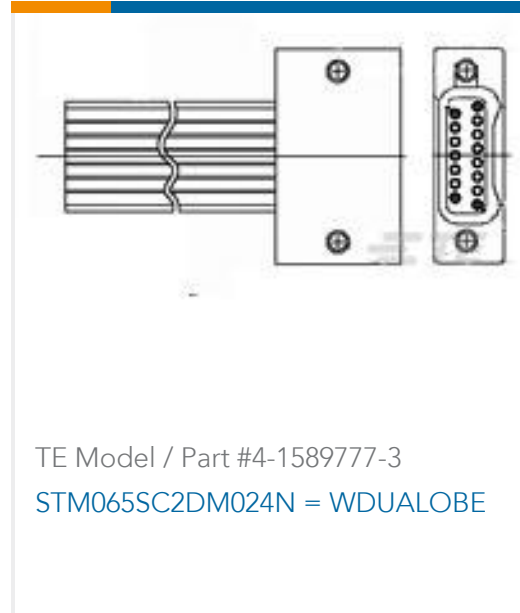
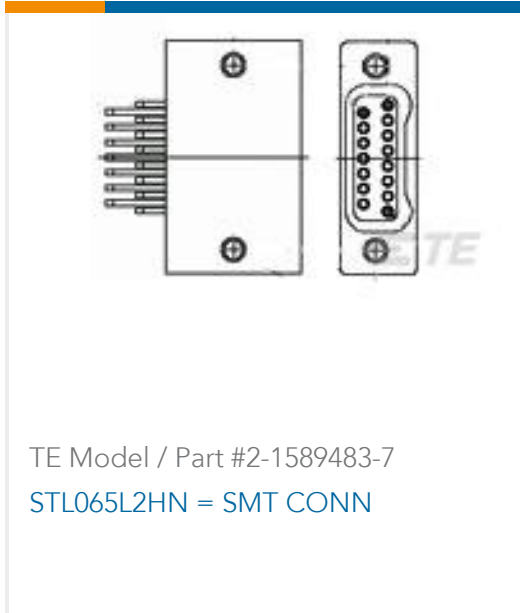
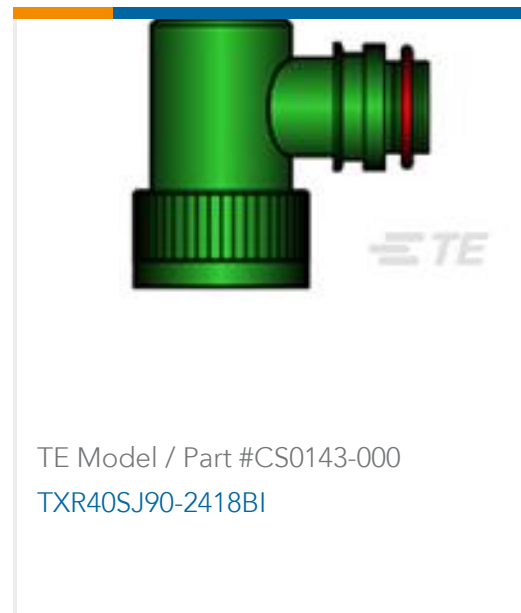
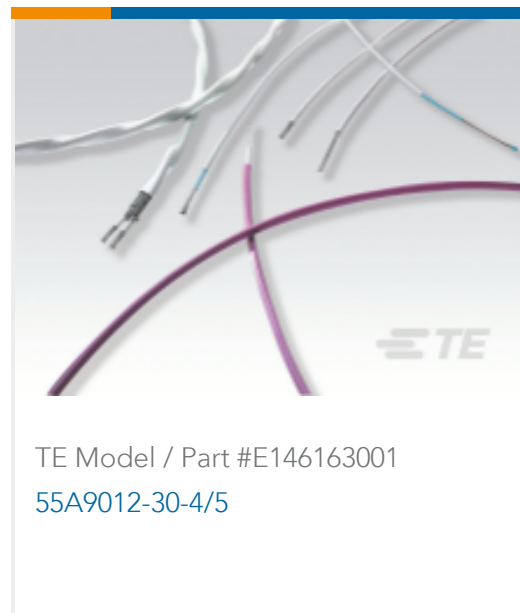

Documents

Product Drawings

[99M1121-22-6/9-0](#)

English

Datasheets & Catalog Pages

[1654025_Sec9_Type99M](#)

English

[Raychem Wire and Cable Quick Reference Guide](#)

English