

EAHP1215WA6



Features

- LM-80 Certified
- High Power COB & High CRI LED
- Multi-Chip Solution
- Dimension: 12 mm x 15 mm x 1.6 mm
- Main Parameters: Luminous Flux, Forward Voltage, Chromaticity and Color Rendering Index
- RoHS compliant
- Energy Star / ANSI Compliant Binning Structure
- Typical Viewing Angle: 115°

Description

Everlight Americas EAHP1215WA6 is a ceramic substrate based LED achieving high efficiency while maintaining high CRI at Energy Star / ANSI color temperature ranges.

Applications

- Replacement Bulb
- Indoor General Lighting
- Recessed Can Lighting

Absolute Maximum Ratings

Parameter	Symbol	Ratings	Unit
Max. DC Forward Current (mA)	I_F	240 _[1]	mA
Max. Peak Pulse Current (mA)	I_{Pulse}	360 _[2]	mA
Power Dissipation	P_d	9	W
Thermal Resistance(junction to board)	R_{th}	2.9	°C/W
Max. Junction Temperature	T_J	125	°C
Operating Temperature	T_{Opr}	-40 ~ +85	°C
Storage Temperature	T_{Stg}	-40 ~ +85	°C

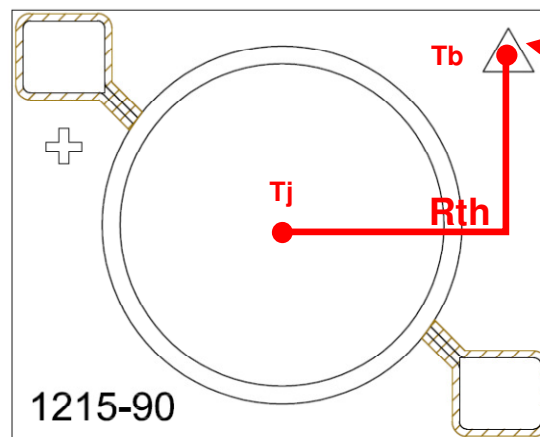

Measuring point
for board
temperature

Notes:

1. For optimal performance, Everlight Americas recommends 240mA operation.
2. $t_p \leq 100ms$, Duty cycle = 25%
3. The EAHP1215WA6 LEDs are not designed for reverse bias use.

PN of the EAHP1215WA6: White LEDs



Order Code of EAHP1215WA6	Minimum Luminous Flux (lm) @T _j =25°C	Typical Luminous Flux (lm) @T _j =25°C	Typical Luminous Flux (lm) @T _j =85°C	CCT (K)	Forward Voltage (V)	Forward Current (mA)	CRI (min.)
EAHP1215WA6	1000	1103	998	57K-1~57K-4	33.0~41.0	240	80

Notes:

1. CRI measurement tolerance: ±2.
2. Luminous flux measurement tolerance: ±10%.
3. The values of luminous flux @ T_j=85°C are calculated and for reference only.
4. Typical luminous flux or light output performance is operated within the condition guided by this datasheet.

Product Binning

Luminous Flux Bins

Group	Bin	Minimum Photometric Flux (lm)	Maximum Photometric Flux (lm)
E	1	4	5
	2	5	6
	3	6	8
	4	8	10
	5	10	13
	6	13	17
	7	17	20
	8	20	23
	9	23	27
F	1	27	33
	2	33	39
	3	39	45
	4	45	52
	5	52	60
	6	60	70
	7	70	80
	8	80	90
	9	90	100

Group	Bin	Minimum Photometric Flux (lm)	Maximum Photometric Flux (lm)
J	1	100	110
	2	110	120
	3	120	130
	4	130	140
	5	140	150
	6	150	160
	7	160	180
	8	180	200
	9	200	225
K	1	225	250
	2	250	275
	3	275	300
	4	300	325
	5	325	350
	6	350	375
	7	375	400
	8	400	425
	9	425	450
N	1	450	475
	2	475	500
	3	500	550
	4	550	600
	5	600	650
	6	650	700
	7	700	750
	8	750	800
	9	800	900
P	1	900	1000
	2	1000	1100
	3	1100	1200
	4	1200	1350
	5	1350	1500
	6	1500	1650
	7	1650	1800

White Bin Structure

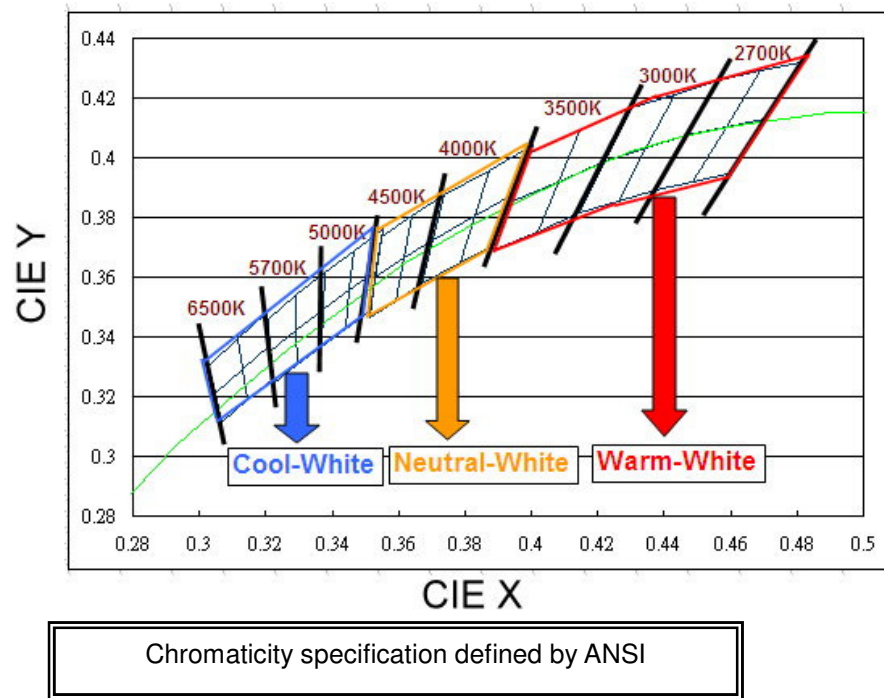

Notes:

1. The CCT range of Cool-White varies from 4745K to 7050K.
2. The CCT range of Neutral-White varies from 3710K to 4745K.
3. The CCT range of Warm-White varies from 2580K to 3710K
4. Color coordinates measurement allowance : ± 0.01
5. Color bins are defined at $I_f=240\text{mA}$ operation

Cool-White Bin Structure

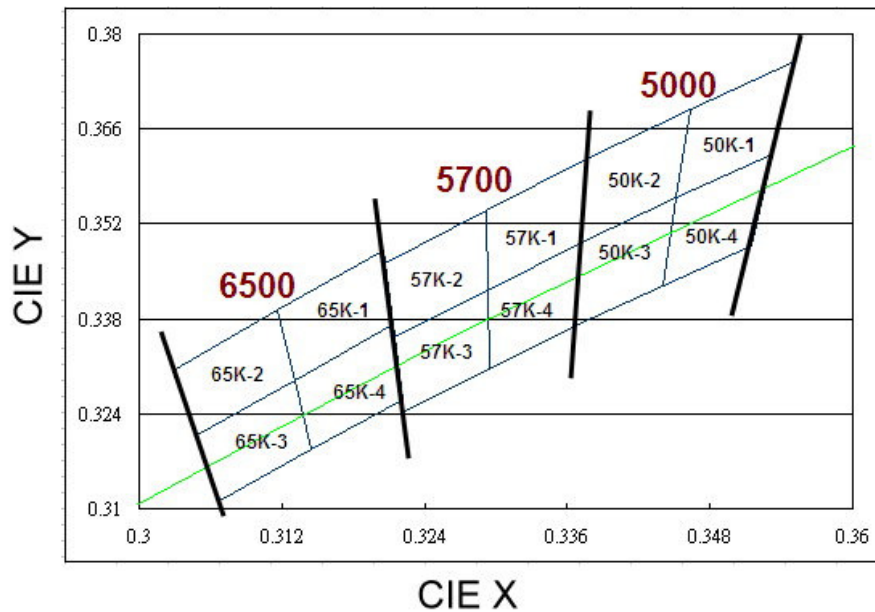

Cool-White Bin Coordinates

5700K

Bin	CIE X	CIE Y
57K-1	0.329	0.354
	0.329	0.342
	0.337	0.349
	0.338	0.362
Reference Range: 5310~5700K		

Bin	CIE X	CIE Y
57K-2	0.321	0.346
	0.322	0.335
	0.329	0.342
	0.329	0.354
Reference Range: 5700~6020K		

Bin	CIE X	CIE Y
57K-4	0.329	0.342
	0.329	0.331
	0.337	0.337
	0.337	0.349
Reference Range: 5310~5700K		

Bin	CIE X	CIE Y
57K-3	0.322	0.335
	0.322	0.324
	0.329	0.331
	0.329	0.342
Reference Range: 5700~6020K		

Notes:

1. Color coordinates measurement allowance : ± 0.01

Forward Voltage Bins

Bin	Minimum Forward Voltage (V)	Maximum Forward Voltage (V)
W4	33.0	35.0
W5	35.0	37.0
W6	37.0	39.0
W7	39.0	41.0

Notes:

1. Forward voltage measurement tolerance: $\pm 2\%$.
2. Forward voltage bins are defined at $I_f=240\text{mA}$ operation.
3. Other Forward Voltage bins for White LEDs available upon request. Please contact your local Everlight Americas sales office.

Mechanical Dimension

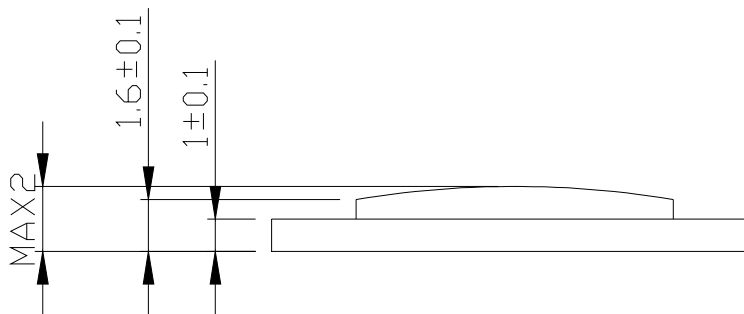
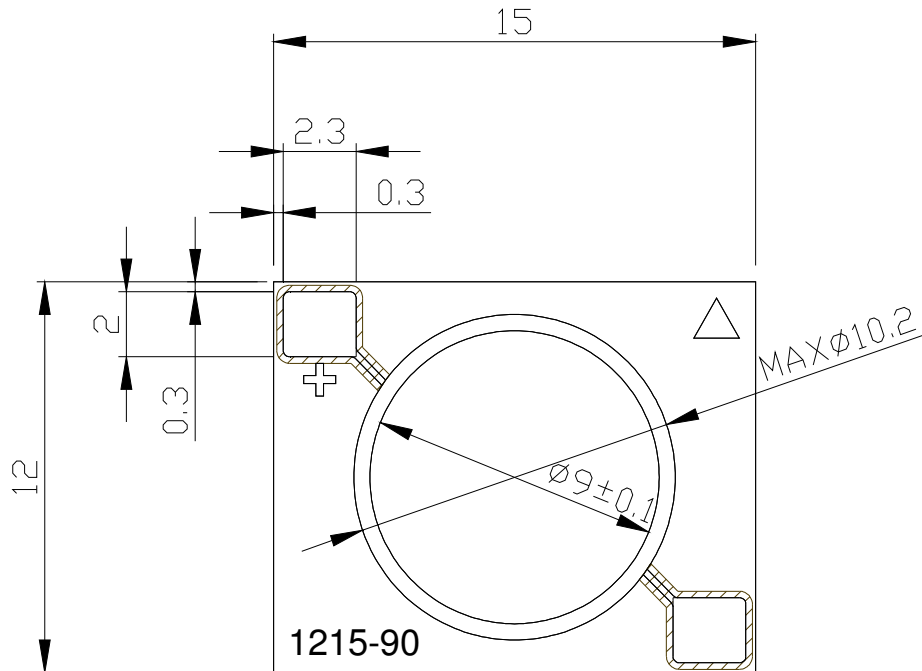

 12 series x 3 parallel

Note:

1. Dimensions are in millimeters.
2. Tolerances unless mentioned are ± 0.1 mm.

Pad Configuration

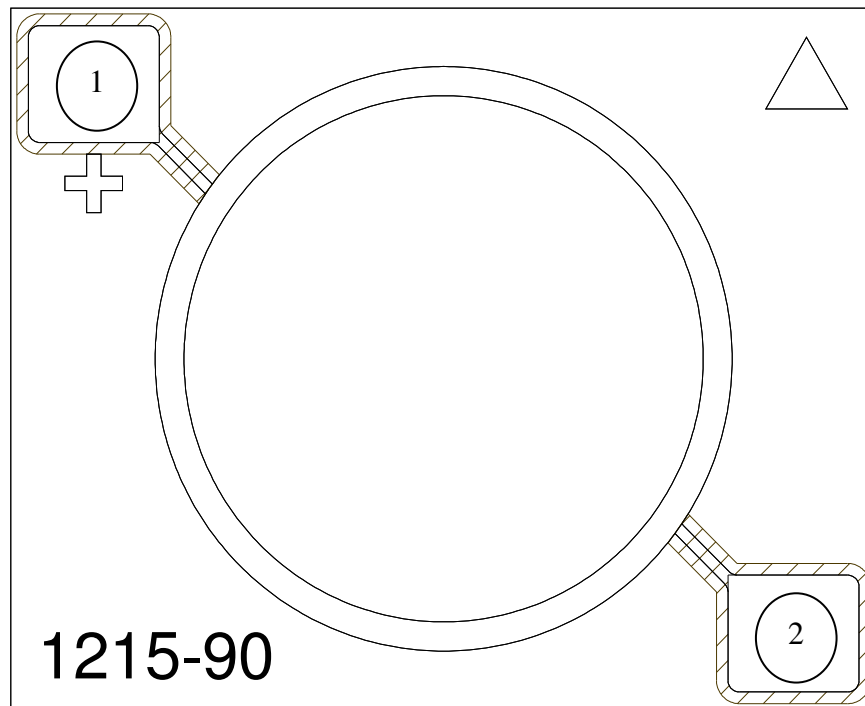

PAD	FUNCTION
1	ANODE
2	CATHODE

Typical Electro-Optical Characteristic Curve

Relative Spectral Distribution
@ Substrate Temperature = 25°C

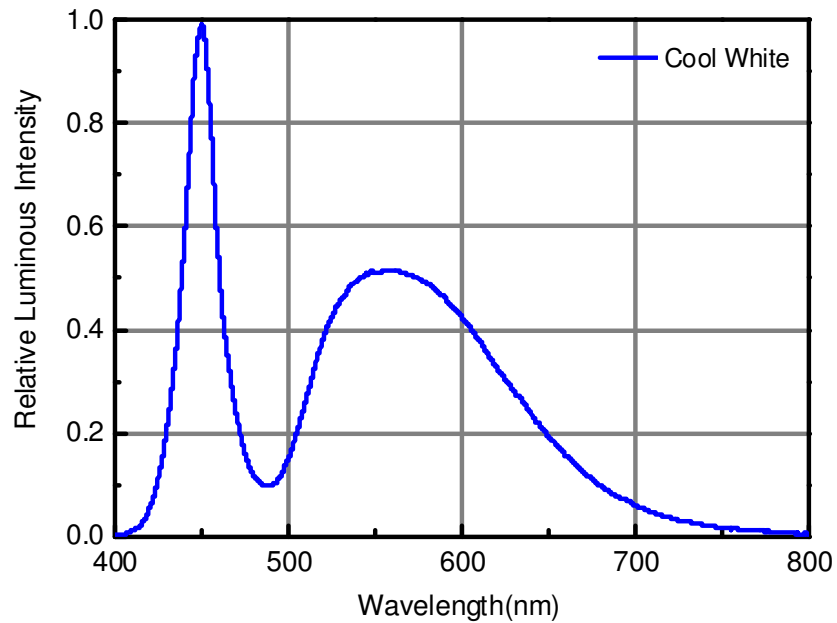

Relative Luminous Flux vs. Substrate Temperature
@Forward Current = 240mA

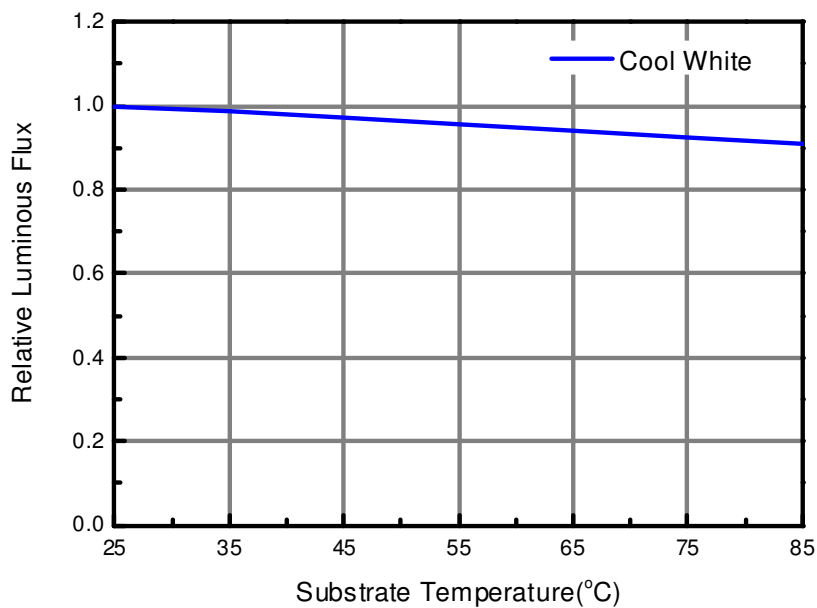

Forward Voltage vs. Forward Current
@ Substrate Temperature = 25°C

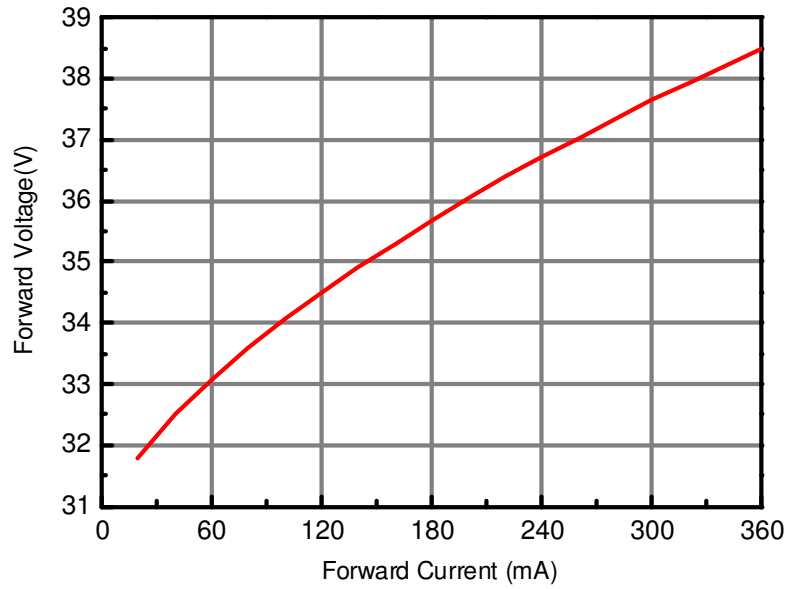

Relative Luminous Flux vs. Forward Current
@ Substrate Temperature = 25°C

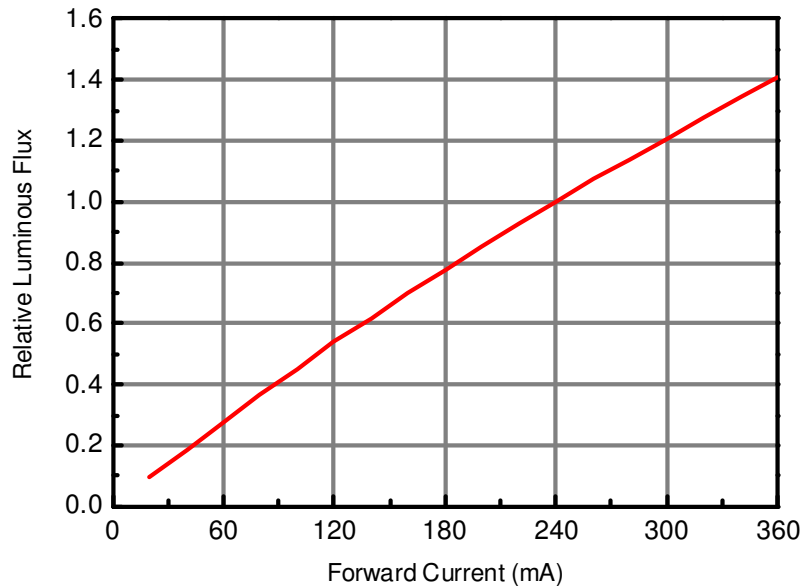

Correlated Color Temperature vs. Forward Current @ Substrate Temperature = 25°C

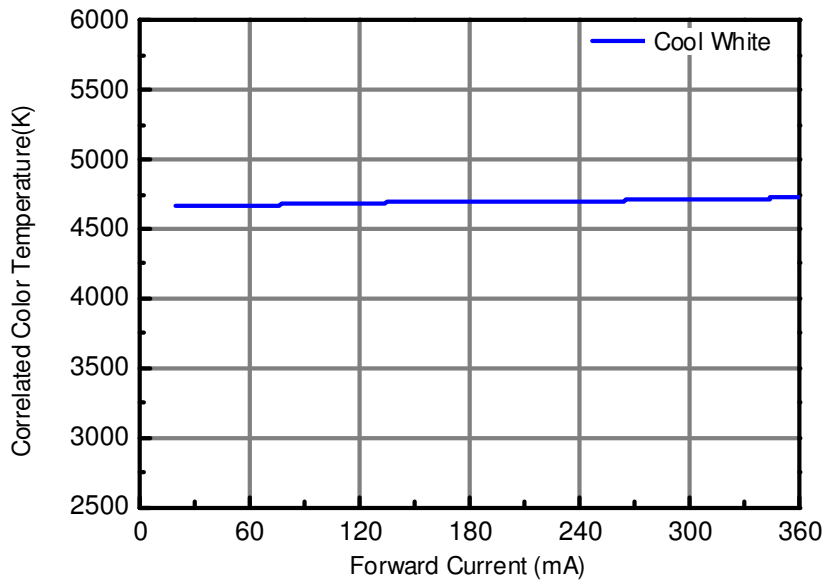

Correlated Color Temperature vs. Substrate Temperature @ Forward Current = 240mA

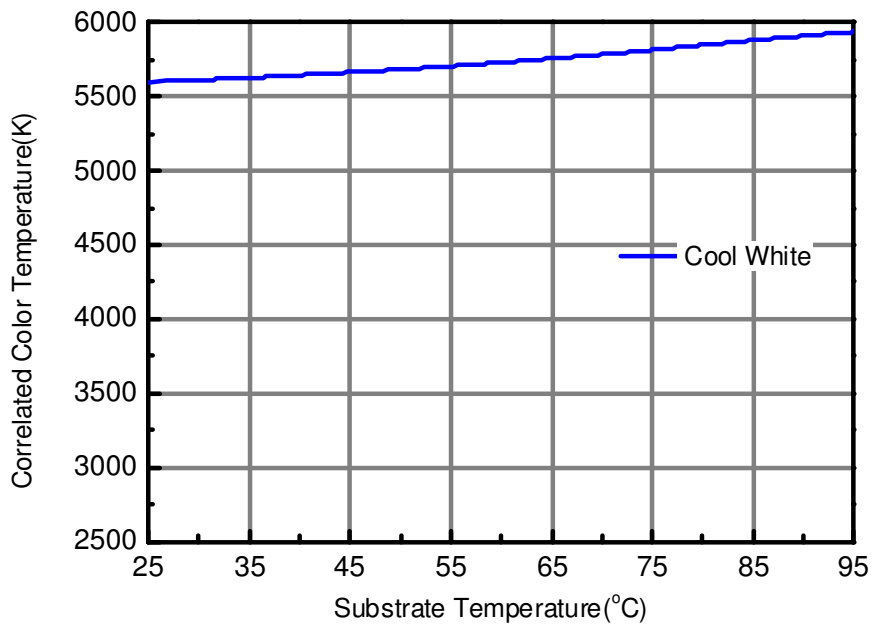

Forward Voltage vs. Substrate Temperature @ Forward Current = 240mA

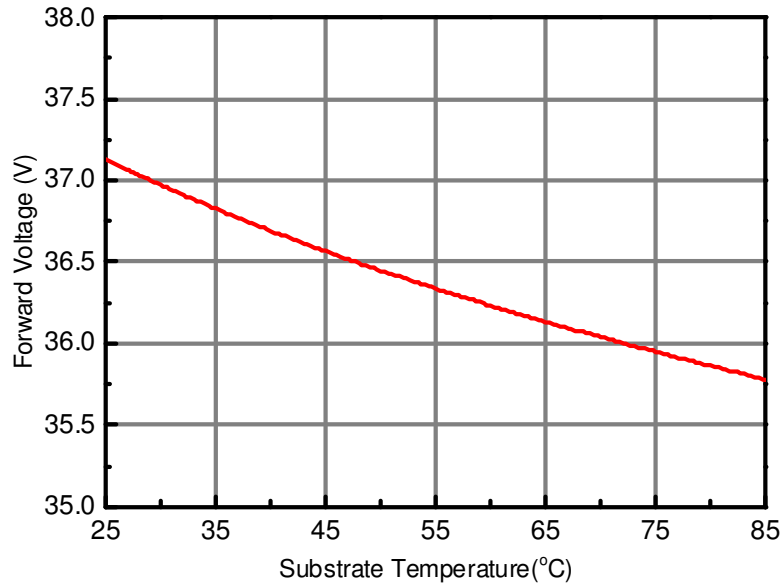

Forward Current Derating Curve @ Junction Temperature <115°C

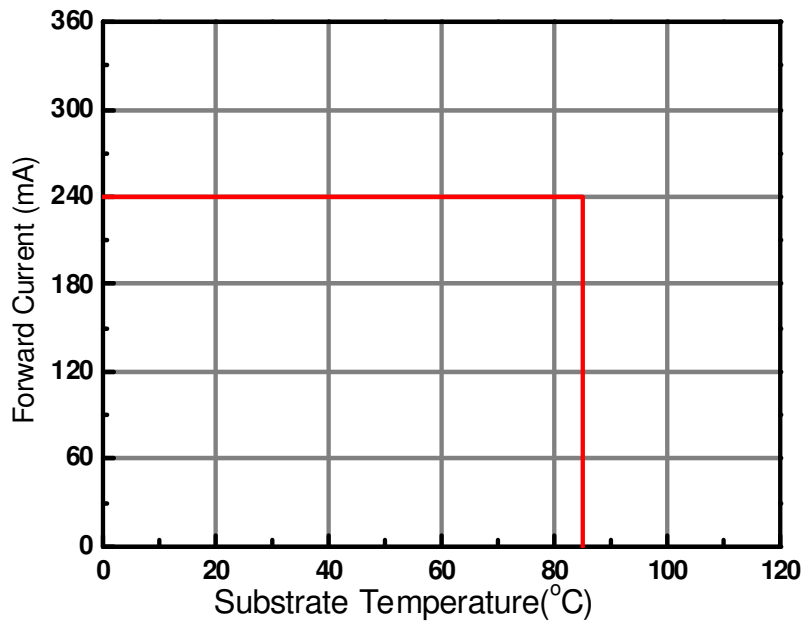

Typical Diagram Characteristics of Radiation Patterns

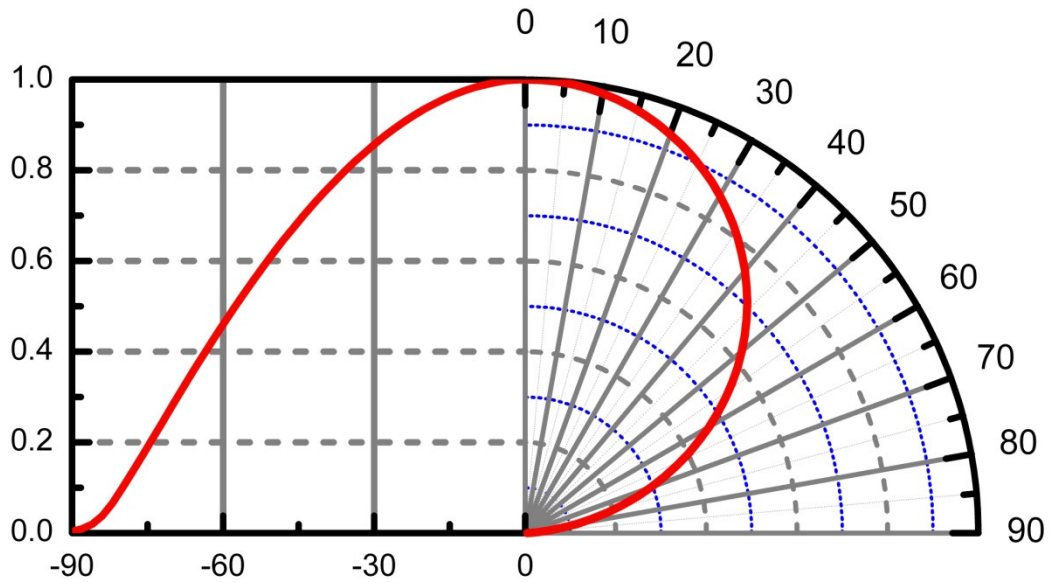

Notes:

1. $2\theta_{1/2}$ is the off axis angle from lamp centerline where the luminous intensity is 1/2 of the peak value.
2. Viewing angle tolerance is $\pm 5^\circ$.

Product Labeling

Label Explanation

CPN: Customer Specification (when required)

P/N : Everlight Americas Production Number

QTY: Packing Quantity

CAT: Luminous Flux (Brightness) Bin

HUE: Color Bin

REF: Forward Voltage Bin

LOT No: Lot Number

MADE IN TAIWAN: Production Place

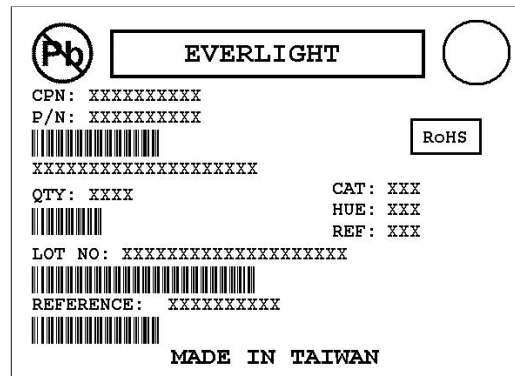

Carrier Tray Specification

Loaded Quantity: 100 PCS Per Tray

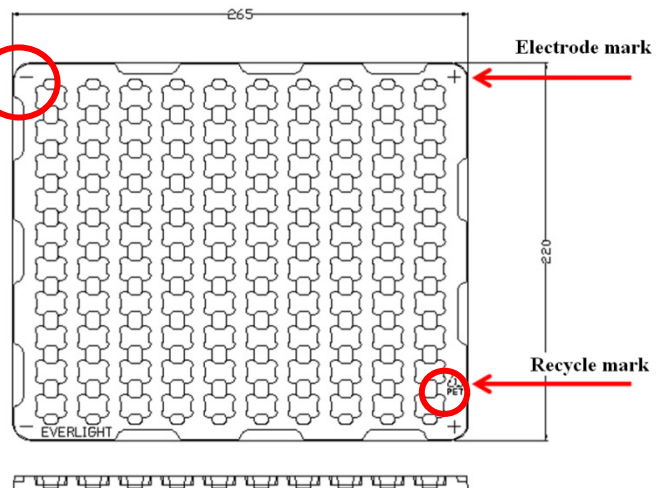

Notes:

1. Dimensions are in millimeters.
2. Tolerances unless mentioned are ± 0.1 mm

LED Direction

- The **Recycle mark** on the LEDs will be toward the **Anode mark** on the carrier tray.

Moisture Resistant Packaging



Outside Carton

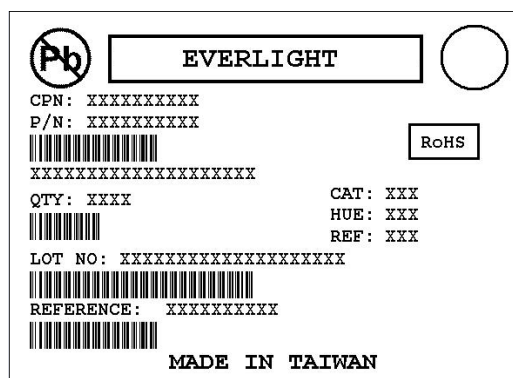
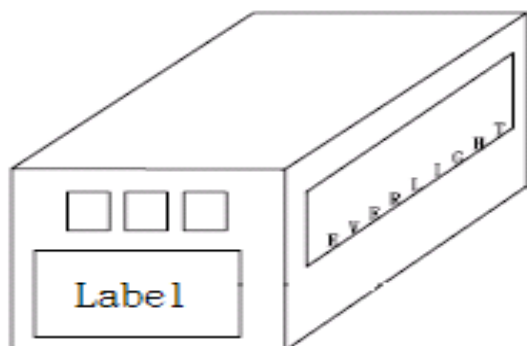

Packaging Quantity

- 100 PCS Per Tray 10 Trays Per Outside Carton

Precautions of Use

Over-Current-Proof

- Though the EAHP1215WA6 has a conducted ESD protection mechanism, customers must not use the device in reverse and should apply resistors for extra protection. Otherwise slight voltage shift may cause significant current changes and burn out failure may happen.

Storage Conditions

- Before the package is opened: The LEDs should be stored at 30°C or less and 50%RH or less after being shipped from Everlight Americas and the storage life limit is 6 months. If the LEDs are stored for 6 months or more, they should be stored in a sealed container with a nitrogen atmosphere and moisture absorbent material.
- After opening the package: The LED should be stored under 30°C or less and 30%RH or less. The LED should be used within 168hrs (7days) after opening the package. If unused LEDs remain, it should be stored in moisture proof packages.
- Do not stack assemblies.



Handling

- Do not put mechanical stress on the LED.
- Never touch the optical surface with finger or sharp object. The LED surface could be soiled or damaged, which could affect the optical performance of the LED.
- In low-humidity work environment, please keep handling the LEDs with appropriate ESD grounding.
- It is recommended to handle the LED with powder-less latex gloves.

Manual Handling

- When handling the product, do not apply direct pressure on the optical surface.
- Do not touch the resin with tweezers to avoid scratching or other damage.

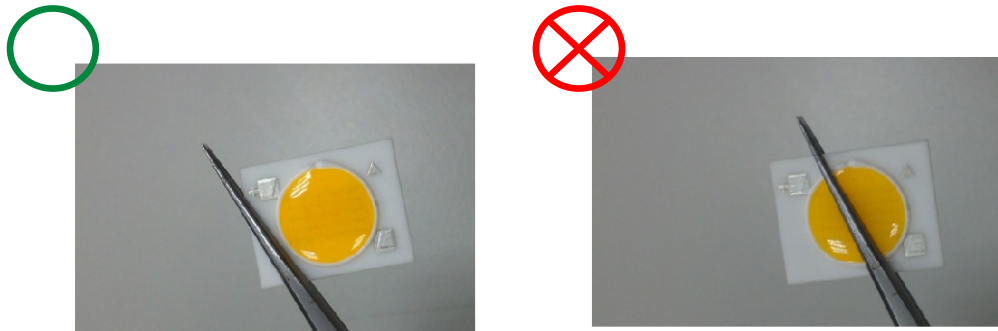

Thermal Management

- Sufficient thermal management must be implemented. Substrate of the positive in temperature must be kept under 105°C at the driving current of 240mA. Otherwise, the junction temperature of die may exceed the limit at high current driving conditions and the LEDs' lifetime may be decrease dramatically.

Revision History

Current version: 10.29.2013

Issue No:

Version: 1

Created by: Leo Chou

Page	Subjects (major change in previous version)	Date of change