Versatile Link

The Versatile Fiber Optic Connection

Technical Data

Features

- Low Cost Fiber Optic Components
- Enhanced Digital Links dc-5 MBd
- Extended Distance Links up to 120 m at 40 kBd
- Low Current Link: 6 mA Peak Supply Current
- Horizontal and Vertical Mounting
- Interlocking Feature
- High Noise Immunity
- Easy Connecting Simplex, Duplex, and Latching Connectors
- Flame Retardant
- Transmitters Incorporate a 660 nm Red LED for Easy Visibility
- Compatible with Standard TTL Circuitry

Applications

- Reduction of Lightning/Voltage Transient Susceptibility
- Motor Controller Triggering
- Data Communications and Local Area Networks
- Electromagnetic Compatibility (EMC) for Regulated Systems: FCC, VDE, CSA, etc.
- Tempest-Secure Data Processing Equipment

- Isolation in Test and Measurement Instruments
- Error Free Signalling for Industrial and Manufacturing Equipment
- Automotive Communications and Control Networks
- Noise Immune Communication in Audio and Video Equipment

Description

The Versatile Link series is a complete family of fiber optic link components for applications requiring a low cost solution. The HFBR-0501 series includes transmitters, receivers, connectors and cable specified for easy design. This series of components is ideal for solving problems with voltage isolation/insulation, EMI/RFI immunity or data security. The optical link design is simplified by the logic compatible receivers and complete specifications for each component. The key optical and electrical parameters of links configured with the HFBR-0501 family are fully guaranteed from 0° to 70°C.

A wide variety of package configurations and connectors provide the designer with numerous mechanical solutions to meet application requirements. The

HFBR-0501 Series

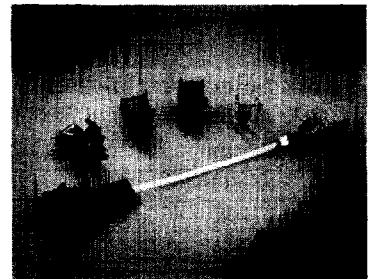

transmitter and receiver components have been designed for use in high volume/low cost assembly processes such as auto insertion and wave soldering.

Transmitters incorporate a 660 nm LED. Receivers include a monolithic dc coupled, digital IC receiver with open collector Schottky output transistor. An internal pullup resistor is available for use in the HFBR-25X1/2/4 receivers. A shield has been integrated into the receiver IC to provide additional, localized noise immunity.

Internal optics have been optimized for use with 1 mm diameter plastic optical fiber. Versatile Link specifications incorporate all connector interface losses. Therefore, optical calculations for common link applications are simplified.

HFBR-0501 Series Part Number Guide

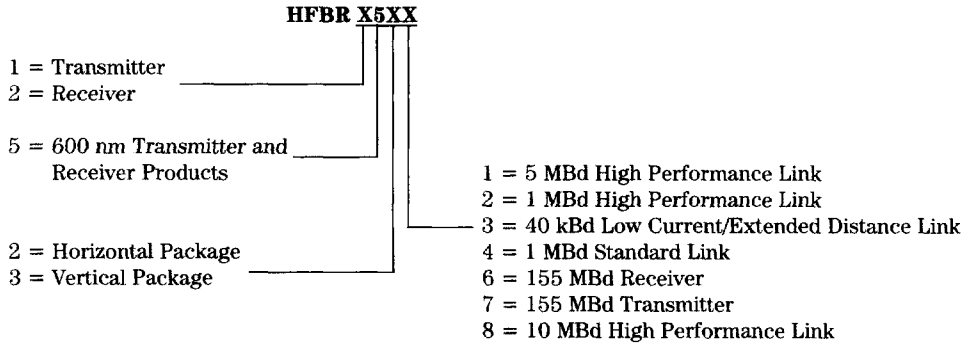

Link Selection Guide

(Links specified from 0 to 70°C, for plastic optical fiber unless specified.)

| Signal Rate | Distance (m) 25°C | Distance (m) | Transmitter | Receiver |
|-------------|-------------------|--------------|-------------|-----------|
| 40 kBd | 120 | 110 | HFBR-1523 | HFBR-2523 |
| 1 MBd | 20 | 10 | HFBR-1524 | HFBR-2524 |
| 1 MBd | 55 | 45 | HFBR-1522 | HFBR-2522 |
| 5 Mb | 30 | 20 | HFBR-1521 | HFBR-2521 |

Evaluation Kit

HFBR-0501 1 MBd Versatile Link:

This kit contains: HFBR-1524 Tx, HFBR-2524 Rx, polishing kit, 3 styles of plastic connectors, Bulkhead feedthrough, 5 meters of 1 mm diameter plastic cable, lapping film and grit paper, and HFBR-0501 data sheet.

Application Literature

Application Note 1035 (Versatile Link)

Package and Handling Information

The compact Versatile Link package is made of a flame retardant VALOX® UL V-0 material (UL file # E121562) and uses the same pad layout as a standard, eight pin dual-in-line package. Vertical and horizontal mountable parts are available. These low profile Versatile Link packages are

stackable and are enclosed to provide a dust resistant seal. Snap action simplex, simplex latching, duplex, and duplex latching connectors are offered with simplex or duplex cables.

Package Orientation

Performance and pinouts for the vertical and horizontal packages are identical. To provide additional attachment support for the

vertical Versatile Link housing, the designer has the option of using a self-tapping screw through a printed circuit board into a mounting hole at the bottom of the package. For most applications this is not necessary.

Package Housing Color

Versatile Link components and simplex connectors are color coded to eliminate confusion

VALOX® is a registered trademark of the General Electric Corporation.

when making connections. Receivers are blue and transmitters are gray, except for the HFBR-15X3 transmitter, which is black.

All of the above transmitters and receivers are also available in black versions for applications where improved housing opacity is required due to very bright ambient light or bright flashes of light.

Handling

Versatile Link components are auto-insertable. When wave soldering is performed with

Versatile Link components, the optical port plug should be left in to prevent contamination of the port. Water soluble fluxes, not rosin based fluxes, are recommended for use with Versatile Link components.

Versatile Link components are moisture sensitive devices and are shipped in a moisture sealed bag. If the components are exposed to air for an extended period of time, they may require a baking step before the soldering process. Refer to the special labeling on the shipping tube for details.

Recommended Chemicals for Cleaning/Degreasing

Alcohols: methyl, isopropyl, isobutyl. *Aliphatics:* hexane, heptane, *Other:* soap solution, naphtha.

Do not use partially halogenated hydrocarbons such as 1,1,1 trichloroethane, ketones such as MEK, acetone, chloroform, ethyl acetate, methylene dichloride, phenol, methylene chloride, or N-methylpyrrolidone. Also, HP does not recommend the use of cleaners that use halogenated hydrocarbons because of their potential environmental harm.

Mechanical Dimensions

Horizontal Modules

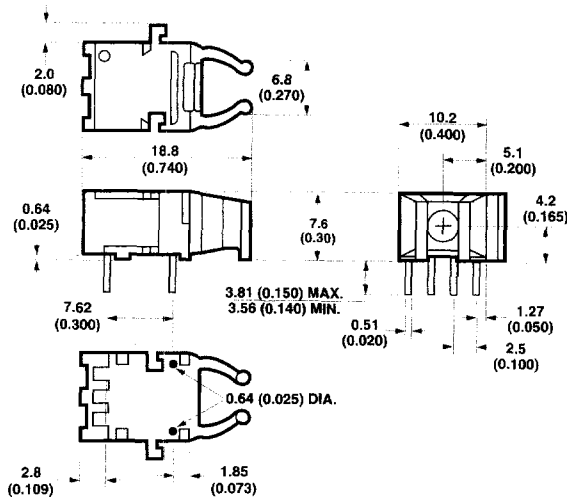

Vertical Modules

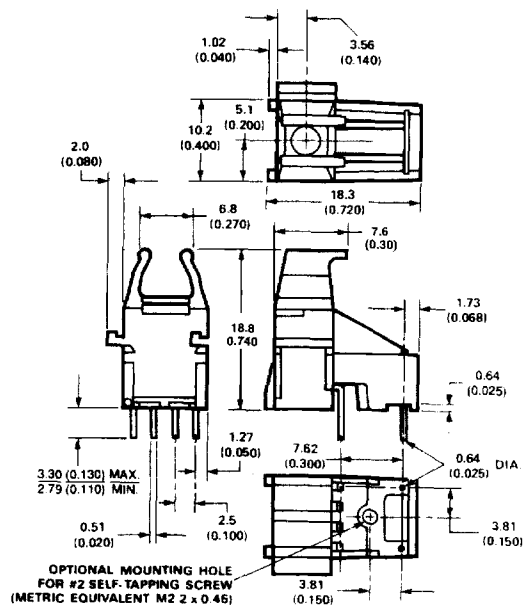

Versatile Link Printed Board Layout Dimensions

Horizontal Module

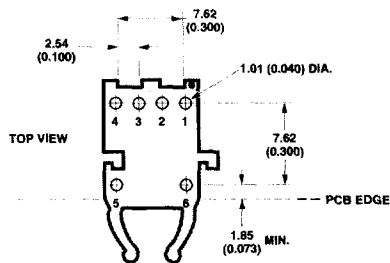

DIMENSIONS IN MILLIMETERS (INCHES).

Vertical Module

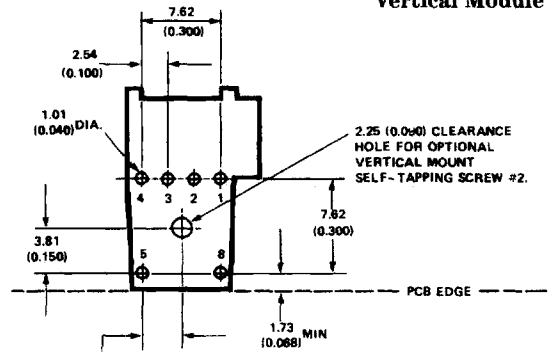

DIMENSIONS IN MILLIMETERS AND (INCHES)

Interlocked (Stacked) Assemblies (refer to Figure 1)

Horizontal packages may be stacked by placing units with pins facing upward. Initially engage the interlocking mechanism by sliding the L bracket body from above into the L slot body of the lower package. Use a straight

edge, such as a ruler, to bring all stacked units into uniform alignment. This technique prevents potential harm that could occur to fingers and hands of assemblers from the package pins. Stacked horizontal packages can be disengaged if necessary. Repeated stacking and unstacking causes no damage to individual units.

To stack vertical packages, hold one unit in each hand, with the pins facing away and the optical ports on the bottom. Slide the L bracket unit into the L slot unit. The straight edge used for horizontal package alignment is not needed.

Stacking Horizontal Modules

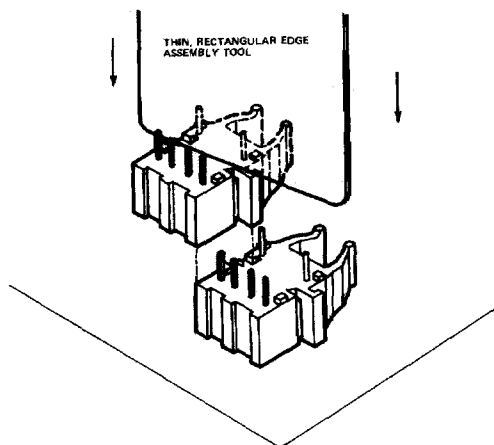

Stacking Vertical Modules

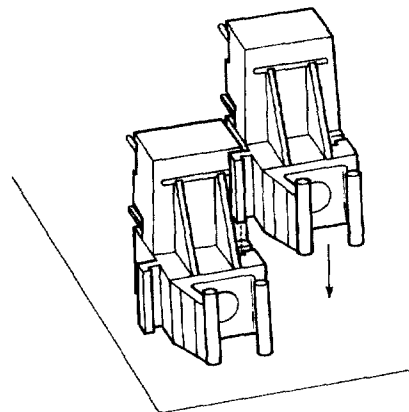

Figure 1. Interlocked (Stacked) Horizontal or Vertical Packages.

5 MBd Link (HFBR-15X1/25X1)

System Performance 0 to 70°C unless otherwise specified.

| | Parameter | Symbol | Min. | Typ. | Max. | Units | Conditions | Ref. |
|---|-----------------------------------|--------|------|------|------|--|---|------------------|
| High Performance 5 MBd | Data Rate | | dc | | 5 | MBd | $BER \leq 10^{-9}$, PRBS:2 ⁷ -1 | |
| | Link Distance (Standard Cable) | l | 19 | | | m | $I_{Fdc} = 60$ mA | Fig. 3 Note 3 |
| | | | 27 | 48 | | m | $I_{Fdc} = 60$ mA, 25°C | |
| | Link Distance (Improved Cable) | l | 22 | | | m | $I_{Fdc} = 60$ mA | Fig. 4 Note 3 |
| | | | 27 | 53 | | m | $I_{Fdc} = 60$ mA, 25°C | |
| Propagation Delay | t_{PLH} t_{PHL} | | 80 | 140 | ns | $R_L = 560 \Omega$, $C_L = 30$ pF | Fig. 5, 8 Notes 1, 2 | |
| | | | 50 | 140 | ns | fiber length = 0.5 m $-21.6 \leq P_R \leq -9.5$ dBm | | |
| Pulse Width Distortion $t_{PLH}-t_{PHL}$ | t_D | | 30 | | ns | $P_R = -15$ dBm $R_L = 560 \Omega$, $C_L = 30$ pF | Fig. 5, 7 | |

Notes:

1. The propagation delay for one metre of cable is typically 5 ns.
2. Typical propagation delay is measured at $P_R = -15$ dBm.
3. Estimated typical link life expectancy at 40°C exceeds 10 years at 60 mA.

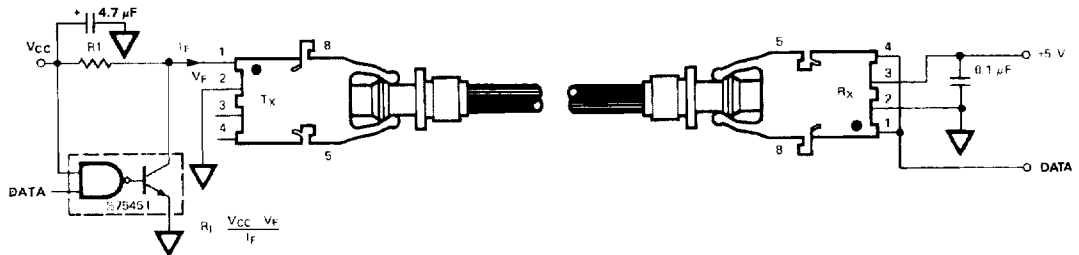

Figure 2. Typical 5 MBd Interface Circuit.

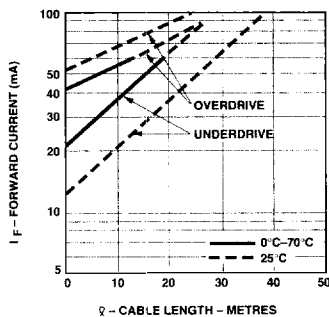

Figure 3. Guaranteed System Performance with Standard Cable (HFBR-15X1/25X1).

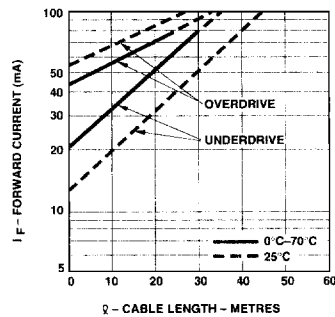

Figure 4. Guaranteed System Performance with Improved Cable (HFBR-15X1/25X1).

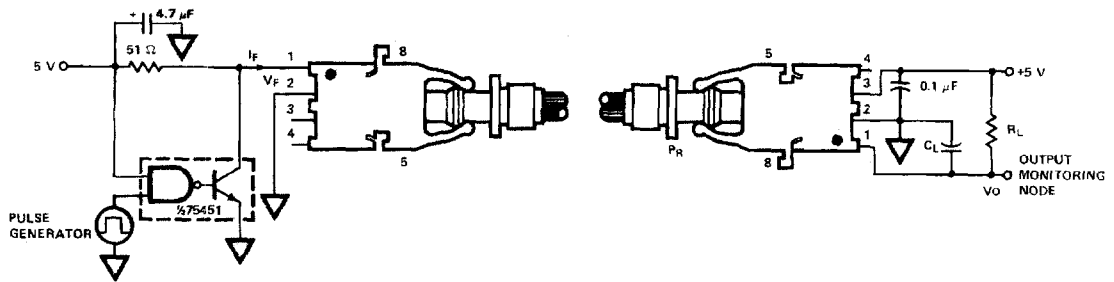

Figure 5. 5 MBd Propagation Delay Test Circuit.

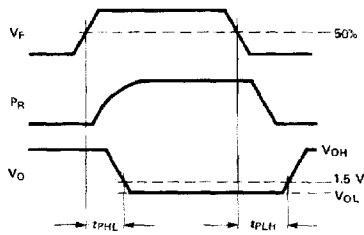

Figure 6. Propagation Delay Test Waveforms.

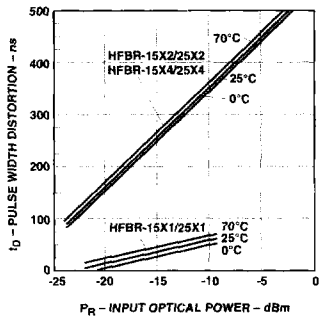

Figure 7. Typical Link Pulse Width Distortion vs. Optical Power.

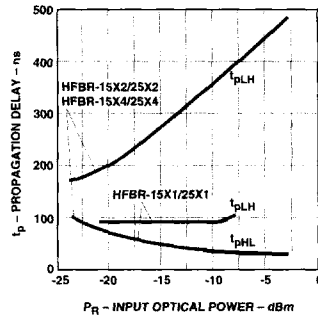
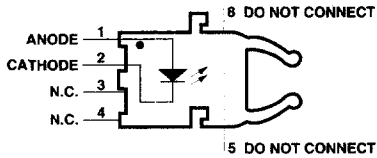

Figure 8. Typical Link Propagation Delay vs. Optical Power.

HFBR-15X1 Transmitter



| Pin # | Function |
|-------|----------------|
| 1 | Anode |
| 2 | Cathode |
| 3 | Open |
| 4 | Open |
| 5 | Do not connect |
| 8 | Do not connect |

Note: Pins 5 and 8 are for mounting and retaining purposes only. Do not electrically connect these pins.

Absolute Maximum Ratings

| Parameter | Symbol | Min. | Max. | Units | Reference |
|-----------------------|-----------|------|------|-------|-----------|
| Storage Temperature | T_S | -40 | +75 | °C | |
| Operating Temperature | T_A | 0 | +70 | °C | |
| Lead Soldering Cycle | Temp. | | 260 | °C | Note 1 |
| | Time | | 10 | sec | |
| Forward Input Current | I_{FPK} | | 1000 | mA | Note 2, 3 |
| | I_{Fdc} | | 80 | | |
| Reverse Input Voltage | V_{BR} | | 5 | V | |

Notes:

- 1.6 mm below seating plane.
- Recommended operating range between 10 and 750 mA.
- 1 μ s pulse, 20 μ s period.

All HFBR-15XX LED transmitters are classified as IEC 825-1 Accessible Emission Limit (AEL) Class 1 based upon the current proposed draft scheduled to go into effect on January 1, 1997. AEL Class 1 LED devices are considered eye safe. Contact your local Hewlett-Packard sales representative for more information.

Transmitter Electrical/Optical Characteristics 0°C to 70°C unless otherwise specified.

| Parameter | Symbol | Min. | Typ. ^[5] | Max. | Units | Conditions | Ref. |
|--|-----------------------|-------|---------------------|------|-------|--|------------|
| Transmitter Output Optical Power | P_T | -16.5 | | -7.6 | dBm | $I_{Fdc} = 60 \text{ mA}$ | Notes 1, 2 |
| | | -14.3 | | -8.0 | dBm | $I_{Fdc} = 60 \text{ mA}, 25^\circ\text{C}$ | |
| Output Optical Power Temperature Coefficient | $\Delta P_T/\Delta T$ | | -0.85 | | %/°C | | |
| Peak Emission Wavelength | λ_{PK} | | 660 | | nm | | |
| Forward Voltage | V_F | 1.45 | 1.67 | 2.02 | V | $I_{Fdc} = 60 \text{ mA}$ | |
| Forward Voltage Temperature Coefficient | $\Delta V_F/\Delta T$ | | -1.37 | | mV/°C | | Fig. 9 |
| Effective Diameter | D | | 1 | | mm | | |
| Numerical Aperture | NA | | 0.5 | | | | |
| Reverse Input Breakdown Voltage | V_{BR} | 5.0 | 11.0 | | V | $I_{Fdc} = 10 \mu\text{A}, T_A = 25^\circ\text{C}$ | |
| Diode Capacitance | C_O | | 86 | | pF | $V_F = 0, f = \text{MHz}$ | |
| Rise Time | t_r | | 80 | | ns | 10% to 90%, $I_F = 60 \text{ mA}$ | Note 3 |
| Fall Time | t_f | | 40 | | ns | | |

Notes:

1. Measured at the end of 0.5 m standard fiber optic cable with large area detector.
2. Optical power, P (dBm) = 10 Log [P(μW)/1000 μW].
3. Rise and fall times are measured with a voltage pulse driving the transmitter and a series connected 50 Ω load. A wide bandwidth optical to electrical waveform analyzer, terminated to a 50 Ω input of a wide bandwidth oscilloscope, is used for this response time measurement.

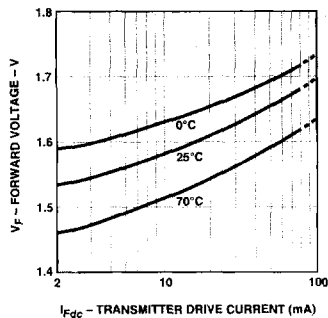

Figure 9. Typical Forward Voltage vs. Drive Current.

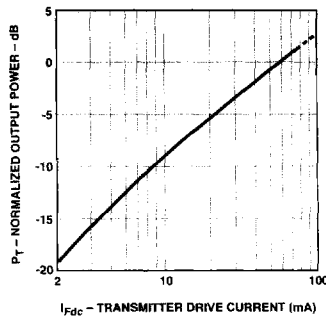
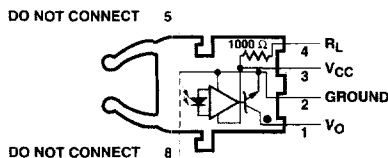

Figure 10. Normalized Typical Output Power vs. Drive Current.

HFBR-25X1 Receiver



| Pin # | Function |
|-------|----------------|
| 1 | V_O |
| 2 | Ground |
| 3 | V_{CC} |
| 4 | R_L |
| 5 | Do not connect |
| 8 | Do not connect |

Note: Pins 5 and 8 are for mounting and retaining purposes only. Do not electrically connect these pins.

Absolute Maximum Ratings

| Parameter | Symbol | Min. | Max. | Units | Reference |
|------------------------------------|-----------|------|----------|-------|-----------|
| Storage Temperature | T_S | -40 | +75 | °C | |
| Operating Temperature | T_A | 0 | +70 | °C | |
| Lead Soldering Cycle | Temp. | | 260 | °C | Note 1 |
| | Time | | 10 | sec | |
| Supply Voltage | V_{CC} | -0.5 | 7 | V | Note 2 |
| Output Collector Current | I_{OAV} | | 25 | mA | |
| Output Collector Power Dissipation | P_{OD} | | 40 | mW | |
| Output Voltage | V_O | -0.5 | 18 | V | |
| Pull-up Voltage | V_P | -5 | V_{CC} | V | |
| Fan Out (TTL) | N | | 5 | | |

Notes:

- 1.6 mm below seating plane.
- It is essential that a bypass capacitor 0.01 μF be connected from pin 2 to pin 3 of the receiver. Total lead length between both ends of the capacitor and the pins should not exceed 20 mm.

Receiver Electrical/Optical Characteristics

0°C to 70°C, 4.75 V $\leq V_{CC} \leq 5.25$ V unless otherwise specified

| Parameter | Symbol | Min. | Typ. | Max. | Units | Conditions | Ref. |
|---|------------|-------|------|------|---------------|--|---------------|
| Input Optical Power Level for Logic "0" | $P_{R(L)}$ | -21.6 | | -9.5 | dBm | $V_{OL} = 0.5$ V $I_{OL} = 8$ mA | Notes 1, 2, 4 |
| | | -21.6 | | -8.7 | | | |
| Input Optical Power Level for Logic "1" | $P_{R(H)}$ | | | -43 | dBm | $V_{OL} = 5.25$ V $I_{OH} \leq 250$ μA | Note 1 |
| High Level Output Current | I_{OH} | | 5 | 250 | μA | $V_O = 18$ V, $P_R = 0$ | Note 3 |
| Low Level Output Current | V_{OL} | | 0.4 | 0.5 | V | $I_{OL} = 8$ mA, $P_R = P_{R(L)MIN}$ | Note 3 |
| High Level Supply Current | I_{CCH} | | 3.5 | 6.3 | mA | $V_{CC} = 5.25$ V, $P_R = 0$ | Note 3 |
| Low Level Supply Current | I_{CCL} | | 6.2 | 10 | mA | $V_{CC} = 5.25$ V $P_R = -12.5$ dBm | Note 3 |
| Effective Diameter | D | | 1 | | mm | | |
| Numerical Aperture | NA | | 0.5 | | | | |
| Internal Pull-up Resistor | R_L | 680 | 1000 | 1700 | Ω | | |

Notes:

- Optical flux, P (dBm) = 10 Log [P (μW)/1000 μW].
- Measured at the end of the fiber optic cable with large area detector.
- R_L is open.
- Pulsed LED operation at $I_F > 80$ mA will cause increased link t_{PLH} propagation delay time. This extended t_{PLH} time contributes to increased pulse width distortion of the receiver output signal.

1 MBd Link

(High Performance HFBR-15X2/25X2, Standard HFBR-15X4/25X4)

System Performance Under recommended operating conditions unless otherwise specified.

| | Parameter | Symbol | Min. | Typ. | Max. | Units | Conditions | Ref. |
|---|-----------------------------------|--------|------|------|------|-------|---|-----------------------------|
| High Performance 1 MBd | Data Rate | | dc | | 1 | MBd | $BER \leq 10^{-9}$, PRBS:2 ⁷ -1 | |
| | Link Distance (Standard Cable) | ℓ | 39 | | | m | $I_{Fdc} = 60$ mA | Fig. 14 Notes 1, 3, 4 |
| | | | 47 | 70 | | m | $I_{Fdc} = 60$ mA, 25°C | |
| | Link Distance (Improved Cable) | ℓ | 45 | | | m | $I_{Fdc} = 60$ mA | Fig. 15 Notes 1, 3, 4 |
| | | | 56 | 78 | | m | $I_{Fdc} = 60$ mA, 25°C | |
| Propagation Delay | t_{PLH} t_{PHL} | | | 180 | 250 | ns | $R_L = 560 \Omega$, $C_L = 30$ pF | Fig. 16, 18 Notes 2, 4 |
| | | | | 100 | 140 | ns | $I = 0.5$ metre $P_R = -24$ dBm | |
| Pulse Width Distortion $t_{PLH}-t_{PHL}$ | t_D | | | 80 | | ns | $P_R = -24$ dBm $R_L = 560 \Omega$, $C_L = 30$ pF | Fig. 16, 17 Note 4 |

| | Parameter | Symbol | Min. | Typ. | Max. | Units | Conditions | Ref. |
|---|-----------------------------------|--------|------|------|------|-------|---|-----------------------------|
| Standard 1 MBd | Data Rate | | dc | | 1 | MBd | $BER \leq 10^{-9}$, PRBS:2 ⁷ -1 | |
| | Link Distance (Standard Cable) | ℓ | 8 | | | m | $I_{Fdc} = 60$ mA | Fig. 12 Notes 1, 3, 4 |
| | | | 17 | 43 | | m | $I_{Fdc} = 60$ mA, 25°C | |
| | Link Distance (Improved Cable) | ℓ | 10 | | | m | $I_{Fdc} = 60$ mA | Fig. 13 Notes 1, 3, 4 |
| | | | 19 | 48 | | m | $I_{Fdc} = 60$ mA, 25°C | |
| Propagation Delay | t_{PLH} t_{PHL} | | | 180 | 250 | ns | $R_L = 560 \Omega$, $C_L = 30$ pF | Fig. 16, 18 Notes 2, 4 |
| | | | | 100 | 140 | ns | $I = 0.5$ metre $P_R = -20$ dBm | |
| Pulse Width Distortion $t_{PLH}-t_{PHL}$ | t_D | | | 80 | | ns | $P_R = -20$ dBm $R_L = 560 \Omega$, $C_L = 30$ pF | Fig. 16, 17 Note 4 |

Notes:

- For $I_{Fpk} > 80$ mA, the duty factor must be such as to keep $I_{Fdc} \leq 80$ mA. In addition, for $I_{Fpk} > 80$ mA, the following rules for pulse width apply:
 $I_{Fpk} \leq 160$ mA: Pulse width ≤ 1 ns
 $I_{Fpk} > 160$ mA: Pulse width ≤ 1 μ s, period ≥ 20 μ s.
- The propagation delay for one meter of cable is typically 5 ns.
- Estimated typical link life expectancy at 40°C exceeds 10 years at 60 mA.
- Pulsed LED operation at $I_{Fpk} > 80$ mA will cause increased link t_{PLH} propagation delay time. This extended t_{PLH} time contributes to increased pulse width distortion of the receiver output signal.

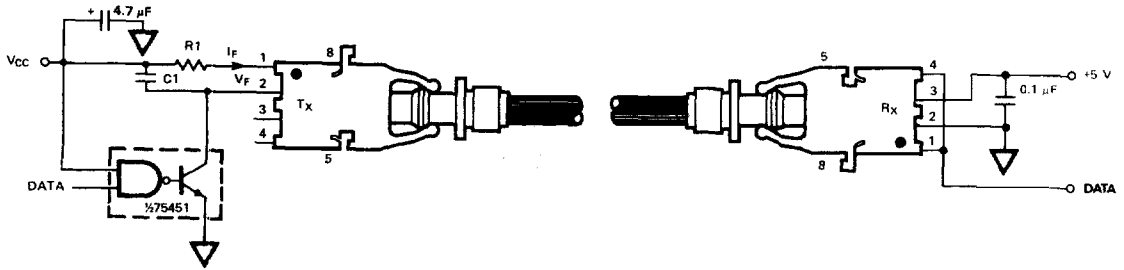

Figure 11. Required 1 MBd Interface Circuit.

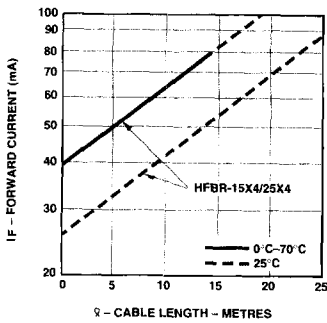

Figure 12. Guaranteed System Performance for the HFBR-15X4/25X4 Link with Standard Cable.

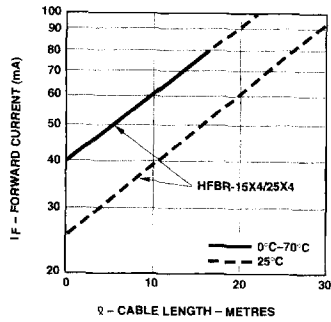

Figure 13. Guaranteed System Performance for the HFBR-15X4/25X4 Link with Improved Cable.

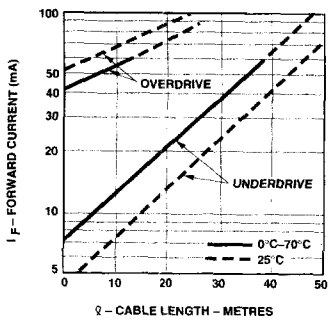

Figure 14. Guaranteed System Performance for the HFBR-15X2/25X2 Link with Standard Cable.

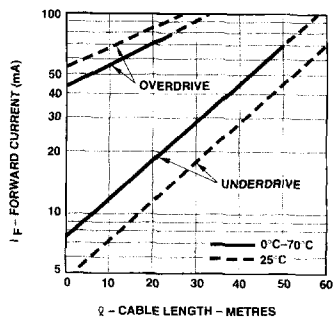

Figure 15. Guaranteed System Performance for the HFBR-15X2/25X2 Link with Improved Cable.

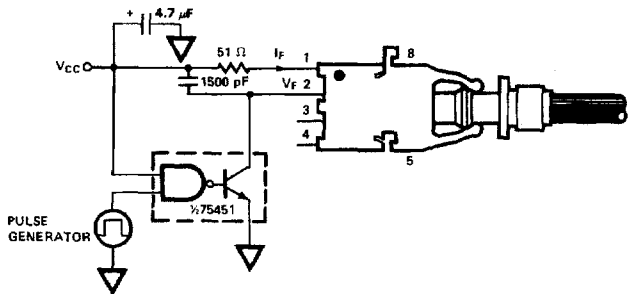

Figure 16. 1 Mbd Propagation Delay Test Circuit.

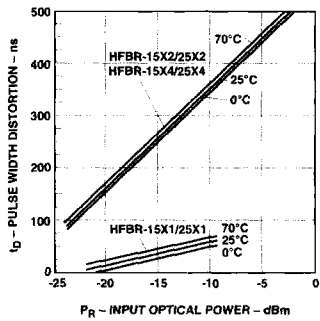

Figure 17. Pulse Width Distortion vs. Optical Power.

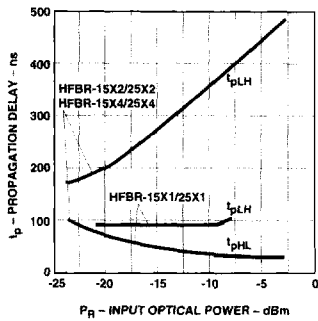

Figure 18. Typical Link Propagation Delay vs. Optical Power.

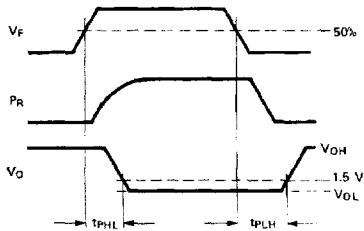
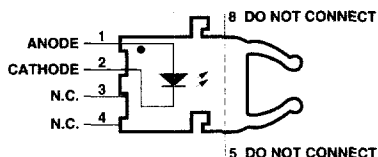

Figure 19. Propagation Delay Test Waveforms.

HFBR-15X2/15X4 Transmitters



| Pin # | Function |
|-------|----------------|
| 1 | Anode |
| 2 | Cathode |
| 3 | Open |
| 4 | Open |
| 5 | Do not connect |
| 8 | Do not connect |

Note: Pins 5 and 8 are for mounting and retaining purposes only. Do not electrically connect these pins.

Absolute Maximum Ratings

| Parameter | Symbol | Min. | Max. | Units | Reference |
|-----------------------|-----------|------|------|-------|-----------|
| Storage Temperature | T_S | -40 | +75 | °C | |
| Operating Temperature | T_A | 0 | +70 | °C | |
| Lead Soldering Cycle | Temp. | | 260 | °C | Note 1 |
| | Time | | 10 | sec | |
| Forward Input Current | I_{FPK} | | 1000 | mA | Note 2, 3 |
| | I_{Fdc} | | 80 | | |
| Reverse Input Voltage | V_{BR} | | 5 | V | |

Notes:

- 1.6 mm below seating plane.
- Recommended operating range between 10 and 750 mA.
- 1 μ s pulse, 20 μ s period.

All HFBR-15XX LED transmitters are classified as IEC 825-1 Accessible Emission Limit (AEL) Class 1 based upon the current proposed draft scheduled to go into effect on January 1, 1997. AEL Class 1 LED devices are considered eye safe. Contact your Hewlett-Packard sales representative for more information.

Transmitter Electrical/Optical Characteristics 0°C to 70°C unless otherwise specified.

For forward voltage and output power vs. drive current graphs.

| Parameter | Symbol | Min. | Typ. | Max. | Units | Conditions | Ref. |
|--|-------------------------|-------|-------|------|-------|---|---------|
| Transmitter Output Power | HFBR-15X2 | P_T | -13.6 | | -4.5 | dBm $I_{Fdc} = 60$ mA $I_{Fdc} = 60$ mA, 25°C | |
| | | | -11.2 | | -5.1 | | |
| Optical Power | HFBR-15X4 | P_T | -17.8 | | -4.5 | dBm $I_{Fdc} = 60$ mA $I_{Fdc} = 60$ mA, 25°C | |
| | | | -15.5 | | -5.1 | | |
| Output Optical Power Temperature Coefficient | $\Delta P_T / \Delta T$ | | -0.85 | | %/°C | | |
| Peak Emission Wavelength | λ_{PK} | | 660 | | nm | | |
| Forward Voltage | V_F | 1.45 | 1.67 | 2.02 | V | $I_{Fdc} = 60$ mA | |
| Forward Voltage Temperature Coefficient | $\Delta V_F / \Delta T$ | | -1.37 | | mV/°C | | Fig. 11 |
| Effective Diameter | D_T | | 1 | | mm | | |
| Numerical Aperture | NA | | 0.5 | | | | |
| Reverse Input Breakdown Voltage | V_{BR} | 5.0 | 11.0 | | V | $I_{Fdc} = 10$ μ A, $T_A = 25^\circ$ C | |
| Diode Capacitance | C_O | | 86 | | pF | $V_F = 0$, $f = 1$ MHz | |
| Rise Time | t_r | | 80 | | ns | 10% to 90% | Note 1 |
| Fall Time | t_f | | 40 | | ns | $I_F = 60$ mA | |

Note:

- Rise and fall times are measured with a voltage pulse driving the transmitter and a series connected 50 Ω load. A wide bandwidth optical to electrical waveform analyzer, terminated to a 50 Ω input of a wide bandwidth oscilloscope, is used for this response time measurement.

HFBR-25X2/25X4 Receivers

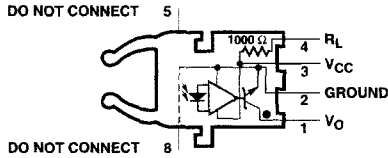

| Pin # | Function |
|-------|-----------------|
| 1 | V _O |
| 2 | Ground |
| 3 | V _{CC} |
| 4 | R _L |
| 5 | Do not connect |
| 8 | Do not connect |

Note: Pins 5 and 8 are for mounting and retaining purposes only. Do not electrically connect these pins.

Absolute Maximum Ratings

| Parameter | Symbol | Min. | Max. | Units | Reference |
|------------------------------------|------------------|------|-----------------|-------|-----------|
| Storage Temperature | T _S | -40 | +75 | °C | |
| Operating Temperature | T _A | 0 | +70 | °C | |
| Lead Soldering Cycle | Temp. | | 260 | °C | Note 1 |
| | Time | | 10 | sec | |
| Supply Voltage | V _{CC} | -0.5 | 7 | V | Note 2 |
| Output Collector Current | I _{OAV} | | 25 | mA | |
| Output Collector Power Dissipation | P _{OD} | | 40 | mW | |
| Output Voltage | V _O | -0.5 | 18 | V | |
| Pull-up Voltage | V _P | -5 | V _{CC} | V | |
| Fan Out (TTL) | N | | 5 | | |

Notes:

- 1.6 mm below seating plane.
- It is essential that a bypass capacitor 0.01 μF be connected from pin 2 to pin 3 of the receiver. Total lead length between both ends of the capacitor and the pins should not exceed 20 mm.

Receiver Electrical/Optical Characteristics 0°C to 70°C, 4.75 V ≤ V_{CC} ≤ 5.25 V unless otherwise specified.

| Parameter | Symbol | Min. | Typ. | Max. | Units | Conditions | Ref. |
|--|-------------------|-------------------|------|------|-------|---|-----------------------------|
| Receiver Optical Input Power Level Logic 0 | HFBR-2522 | P _{R(L)} | -24 | | | V _{OL} = 0 V I _{OL} = 8 mA | Notes 1, 2, 3 Note 4 |
| | HFBR-2524 | | -20 | | | | |
| Optical Input Power Level Logic 1 | P _{R(H)} | | | -43 | dBm | V _{OH} = 5.25 V I _{OH} = ≤ 250 μA | |
| High Level Output Current | I _{OH} | | 5 | 250 | μA | V _O = 18 V, P _R = 0 | Note 5 |
| Low Level Output Voltage | V _{OL} | | 0.4 | 0.5 | V | I _{OL} = 8 mA P _R = P _{R(L)MIN} | Note 5 |
| High Level Supply Current | I _{CCH} | | 3.5 | 6.3 | mA | V _{CC} = 5.25 V, P _R = 0 | Note 5 |
| Low Level Supply Current | I _{CCL} | | 6.2 | 10 | mA | V _{CC} = 5.25 V, P _R = -12.5 dBm | Note 5 |
| Effective Diameter | D | | 1 | | mm | | |
| Numerical Aperture | NA | | 0.5 | | | | |
| Internal Pull-up Resistor | R _L | 680 | 1000 | 1700 | Ω | | |

Notes:

- Measured at the end of the fiber optic cable with large area detector.
- Pulsed LED operation at I_F > 80 mA will cause increased link t_{PLH} propagation delay time. This extended t_{PLH} time contributes to increased pulse width distortion of the receiver output signal.
- The LED drive circuit of Figure 11 is required for 1 MBd operation of the HFBR-25X2/25X4.
- Optical flux, P (dBm) = 10 Log [P(μW)/1000 μW].
- R_L is open.

40 kBd Link

System Performance Under recommended operating conditions unless otherwise specified.

| Parameter | Symbol | Min. | Typ. | Max. | Units | Conditions | Ref. |
|---|------------------------|------|------|------|---------------|--|-----------------------|
| Data Rate | | dc | | 40 | kBd | $BER \leq 10^{-9}$, PRBS: $2^7 - 1$ | |
| Link Distance (Standard Cable) | ℓ | 13 | 41 | | m | $I_{Fdc} = 2 \text{ mA}$ $I_{Fdc} = 60 \text{ mA}$ | Fig. 21 Note 1 |
| | | 94 | 138 | | m | | |
| Link Distance (Improved Cable) | ℓ | 15 | 45 | | m | $I_{Fdc} = 2 \text{ mA}$ $I_{Fdc} = 60 \text{ mA}$ | Fig. 22 Note 1 |
| | | 111 | 154 | | m | | |
| Propagation Delay | t_{PLH} t_{PHL} | | 4 | | μs | $R_L = 3.3 \text{ k}\Omega$, $C_L = 30 \text{ pF}$ $P_R = -25 \text{ dBm}$, 1 m fiber | Fig. 22, 25 Note 2 |
| | | | 2.5 | | μs | | |
| Pulse Width Distortion $t_{PLH}-t_{PHL}$ | t_D | | | 7 | μs | $-39 \leq P_R \leq -14 \text{ dBm}$ $R_L = 3.3 \text{ k}\Omega$, $C_L = 30 \text{ pF}$ | Fig. 23, 24 |

Notes:

1. Estimated typical link life expectancy at 40°C exceeds 10 years at 60 mA.
2. The propagation delay for one metre of cable is typically 5 ns.

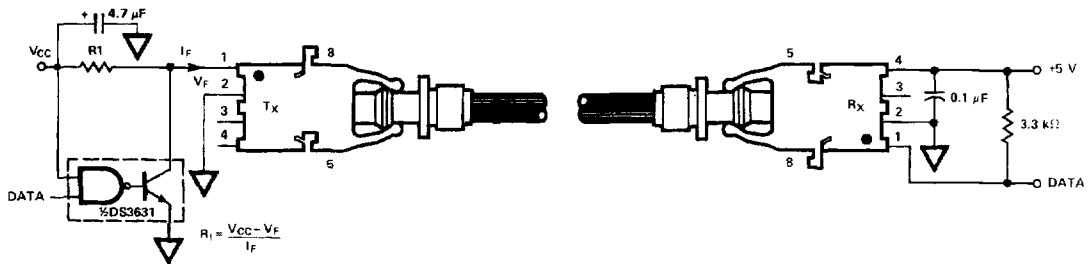

Figure 20. Typical 40 kBd Interface Circuit.

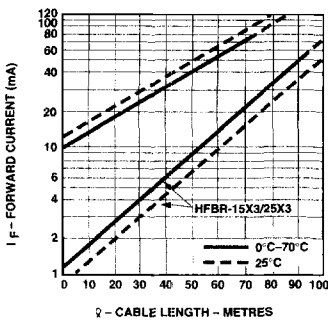

Figure 21. Guaranteed System Performance with Standard Cable.

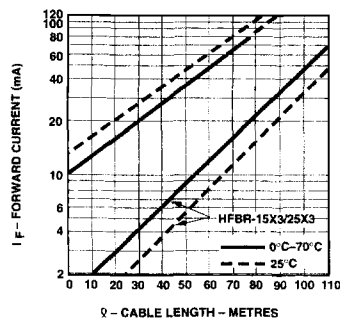

Figure 22. Guaranteed System Performance with Improved Cable.

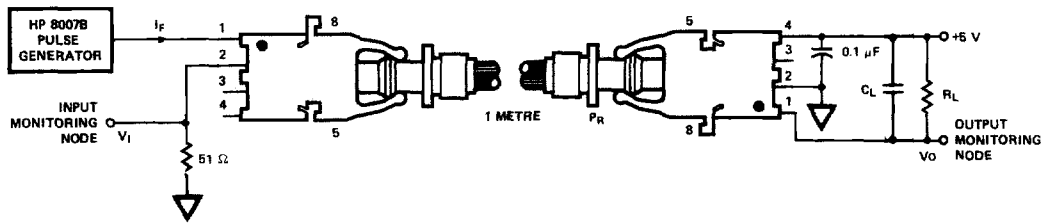

Figure 23. 40 kBd Propagation Delay Test Circuit.

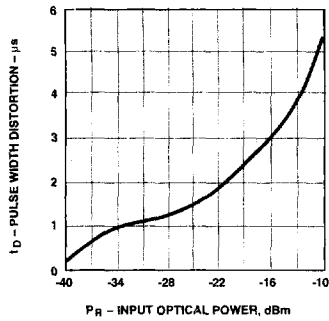

Figure 24. Typical Link Pulse Width Distortion vs. Optical Power.

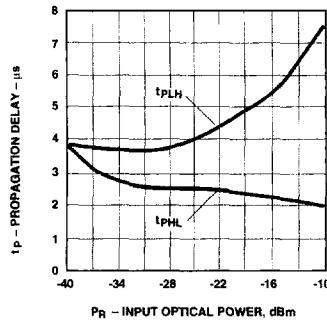

Figure 25. Typical Link Propagation Delay vs. Optical Power.

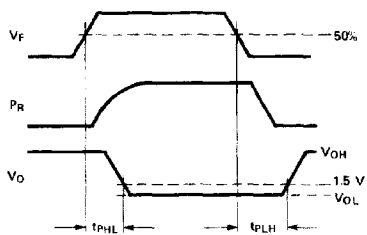
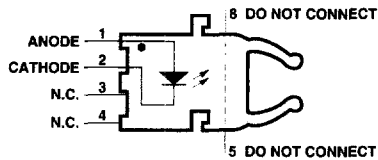

Figure 26. Propagation Delay Test Waveforms.

HFBR-15X3 Transmitter



| Pin # | Function |
|-------|----------------|
| 1 | Anode |
| 2 | Cathode |
| 3 | Open |
| 4 | Open |
| 5 | Do not connect |
| 8 | Do not connect |

Note: Pins 5 and 8 are for mounting and retaining purposes only. Do not electrically connect these pins.

Absolute Maximum Ratings

| Parameter | Symbol | Min. | Max. | Units | Reference |
|-----------------------|-----------|------|------|-------|-----------|
| Storage Temperature | T_S | -40 | +75 | °C | |
| Operating Temperature | T_A | 0 | +70 | °C | |
| Lead Soldering Cycle | Temp. | | 260 | °C | Note 1 |
| | Time | | 10 | sec | |
| Forward Input Current | I_{FPK} | | 1000 | mA | Note 2, 3 |
| | I_{Fdc} | | 80 | | |
| Reverse Input Voltage | V_{BR} | | 5 | V | |

Notes:

- 1.6 mm below seating plane.
- Recommended operating range between 10 and 750 mA.
- 1 μ s pulse, 20 μ s period.

All HFBR-15XX LED transmitters are classified as IEC 825-1 Accessible Emission Limit (AEL) Class 1 based upon the current proposed draft scheduled to go into effect on January 1, 1997. AEL Class 1 LED devices are considered eye safe. Contact your Hewlett-Packard sales representative for more information.

Transmitter Electrical/Optical Characteristics 0°C to 70°C unless otherwise specified.

For forward voltage and output power vs. drive current graphs.

| Parameter | Symbol | Min. | Typ. | Max. | Units | Conditions | Ref. |
|--|-------------------------|-------|-------|------|-------|---------------------------------------|------------|
| Transmitter Output Optical Power | P_T | -11.2 | | -5.1 | dBm | $I_{Fdc} = 60$ mA, 25°C | Notes 3, 4 |
| | | -13.6 | | -4.5 | | | |
| | | -35.5 | | | | | |
| Output Optical Power Temperature Coefficient | $\Delta P_T / \Delta T$ | | -0.85 | | %/°C | | |
| Peak Emission Wavelength | λ_{PK} | | 660 | | nm | | |
| Forward Voltage | V_F | 1.45 | 1.67 | 2.02 | V | $I_{Fdc} = 60$ mA | |
| Forward Voltage Temperature Coefficient | $\Delta V_F / \Delta T$ | | -1.37 | | mV/°C | | Fig. 18 |
| Effective Diameter | D | | 1 | | mm | | |
| Numerical Aperture | NA | | 0.5 | | | | |
| Reverse Input Breakdown Voltage | V_{BR} | 5.0 | 11.0 | | V | $I_{Fdc} = 10$ μ A, $T_A = 25$ °C | |
| Diode Capacitance | C_O | | 86 | | pF | $V_F = 0$, $f = 1$ MHz | |
| Rise Time | t_r | | 80 | | ns | 10% to 90%, $I_F = 60$ mA | Note 1 |
| Fall Time | t_f | | 40 | | | | |

Note:

- Rise and fall times are measured with a voltage pulse driving the transmitter and a series connected 50 Ω load. A wide bandwidth optical to electrical waveform analyzer, terminated to a 50 Ω input of a wide bandwidth oscilloscope, is used for this response time measurement.

HFBR-25X3 Receiver

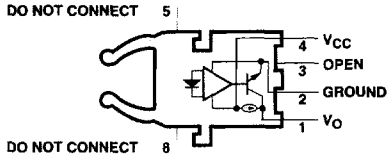

| Pin # | Function |
|-------|----------------|
| 1 | V_O |
| 2 | Ground |
| 3 | Open |
| 4 | V_{CC} |
| 5 | Do not connect |
| 8 | Do not connect |

Note: Pins 5 and 8 are for mounting and retaining purposes only. Do not electrically connect these pins.

Absolute Maximum Ratings

| Parameter | Symbol | Min. | Max. | Units | Reference |
|------------------------------------|----------|------|------|--------------------|-----------|
| Storage Temperature | T_S | -40 | +75 | $^{\circ}\text{C}$ | |
| Operating Temperature | T_A | 0 | +70 | $^{\circ}\text{C}$ | |
| Lead Soldering Cycle | Temp. | | 260 | $^{\circ}\text{C}$ | Note 1 |
| | Time | | 10 | sec | |
| Supply Voltage | V_{CC} | -0.5 | 7 | V | Note 2 |
| Average Output Collector Current | I_O | -1 | 5 | mA | |
| Output Collector Power Dissipation | P_{OD} | | 25 | mW | |
| Output Voltage | V_O | -0.5 | 7 | V | |

Notes:

- 1.6 mm below seating plane.
- It is essential that a bypass capacitor 0.01 μF be connected from pin 2 to pin 3 of the receiver.

Receiver Electrical/Optical Characteristics 0°C to 70°C , $4.5\text{ V} \leq V_{CC} \leq 5.5\text{ V}$ unless otherwise specified.

| Parameter | Symbol | Min. | Typ. | Max. | Units | Conditions | Ref. |
|---------------------------|------------|------|------|-------|-------|--|---------------|
| Input Optical Power | $P_{R(L)}$ | -39 | | -13.7 | dBm | $V_O = V_{OL}$, $I_{OL} = 3.2\text{ mA}$ | Notes 1, 2, 3 |
| Level Logic 0 | | -39 | | -13.3 | | | |
| Input Optical Power | $P_{R(H)}$ | | | -53 | dBm | $V_{OH} = 5.5\text{ V}$ $I_{OH} = \leq 40\text{ }\mu\text{A}$ | Note 3 |
| Level Logic 1 | | | | | | | |
| High Level Output Voltage | V_{OH} | 2.4 | | | V | $I_O = -40\text{ }\mu\text{A}$, $P_R = 0\text{ }\mu\text{W}$ | |
| Low Level Output Voltage | V_{OL} | | | 0.4 | V | $I_{OL} = 3.2\text{ mA}$ $P_R = P_{R(L)MIN}$ | Note 4 |
| High Level Supply Current | I_{CCH} | | 1.2 | 1.9 | mA | $V_{CC} = 5.5\text{ V}$, $P_R = 0\text{ }\mu\text{W}$ | |
| Low Level Supply Current | I_{CCL} | | 2.9 | 3.7 | mA | $V_{CC} = 5.5\text{ V}$, $P_R = P_{RL}(\text{MIN})$ | Note 4 |
| Effective Diameter | D | | 1 | | mm | | |
| Numerical Aperture | NA | | 0.5 | | | | |

Notes:

- Measured at the end of the fiber optic cable with large area detector.
- Optical flux, P (dBm) = $10 \log P(\mu\text{W})/1000\text{ }\mu\text{W}$.
- Because of the very high sensitivity of the HFBR-25X3, the digital output may switch in response to ambient light levels when a cable is not occupying the receiver optical port. The designer should take care to filter out signals from this source if they pose a hazard to the system.
- Including current in 3.3 k pull-up resistor.