

# AN2526FH

## Automotive LCD color TV signal processor IC

### ■ Overview

The AN2526FH is an IC optimized for the automotive TV, incorporating a synchronous stabilizing circuit into the LCD signal processor IC. In response to the demand for a compact and low cost set product, it is available not only for the three-wire serial control but also for the I<sup>2</sup>C bus control.

### ■ Features

- Volume-less thanks to built-in I<sup>2</sup>C
- High performance synchronous stabilizing circuit built-in
- Analog OSD
- PWM circuit built in (Duty variable)
- Difference from AN2526NFH

Unlike the AN2526NFH, it controls a synchronous system gain at no signal input, thus causing no screen abnormalities like shaking sideways. (It is suited for the set featuring in no signal input mode.)

### ■ Applications

- Automotive TV

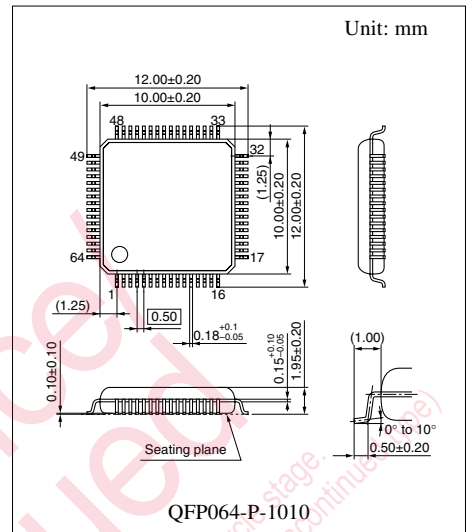

Note) The package of this product will be changed to lead-free type (QFP064-P-1010A). See the new package dimensions section later of this datasheet.







## ■ Pin Descriptions

Pin No.	Description	Pin No.	Description
1	V <sub>CC1</sub> (5.0 V)	33	PWM output pin
2	Reference voltage pin	34	Power-on reset detection pin
3	R-ch. clamp detection pin	35	Vertical synchronous signal input pin
4	G-ch. clamp detection pin	36	1H reverse signal input pin
5	B-ch. clamp detection pin	37	Clock-system GND (V <sub>SS</sub> )
6	R-ch. decoder output pin	38	Clamp pulse input pin
7	G-ch. decoder output pin	39	DAC monitor pin
8	B-ch. decoder output pin	40	Clock-system power supply (3.0 V)
9	R-ch. analog signal input pin	41	GND 2
10	G-ch. analog signal input pin	42	Analog imposing control signal input pin
11	B-ch. analog signal input pin	43	AFC loop filter connecting pin
12	R-ch. analog/character signal input pin	44	VCO frequency adjustment pin
13	G-ch. analog/character signal input pin	45	Synchronous signal input pin
14	B-ch. analog/character signal input pin	46	Serial/I <sup>2</sup> C bus switching pin
15	Black level indication control signal input pin	47	Serial data shift clock input pin
16	Character picking up pulse input pin	48	Serial data input pin
17	B-ch. output pin	49	Serial data write pulse input pin
18	B-ch. output DC feedback detection pin	50	ACC detection pin
19	G-ch. output pin	51	ACC input pin
20	V <sub>CC2</sub> (7.5 V)	52	Horizontal clock detection pin
21	Drive output reference potential input pin	53	Chrominance killer detection pin
22	GND 1	54	APC detection pin
23	G-ch. output DC feedback detection pin	55	VXO input pin
24	R-ch. output pin	56	VXO output pin
25	R-ch. output DC feedback detection pin	57	Y-system clamp detection pin
26	Common reverse signal output pin	58	Chrominance signal trap filter connection pin
27	Testing pulse input pin	59	GND 3
28	Testing clock input pin	60	Luminance signal input pin
29	Field identification signal output pin	61	R-Y output pin
30	Composite synchronous signal output pin	62	B-Y output pin
31	Vertical synchronous signal output pin	63	R-Y input pin
32	Horizontal synchronous signal output pin	64	B-Y input pin

### ■ Absolute Maximum Ratings

Parameter	Symbol	Rating	Unit
Supply voltage	$V_{CC1}$	5.5	V
	$V_{CC2}$	8.5	
Supply current	$I_{CC}$	—	mA
Power dissipation *2	$P_D$	423	mW
Operating ambient temperature *1	$T_{opr}$	-30 to +85	°C
Storage temperature *1	$T_{stg}$	-55 to +150	°C

Note) \*1: Except for the operating ambient temperature and storage temperature, all ratings are for  $T_a = 25^\circ\text{C}$ .

\*2: The power dissipation shown is the value in free air for  $T_{opr} = 85^\circ\text{C}$ .

### ■ Recommended Operating Range

Parameter	Symbol	Range	Unit
Supply voltage	$V_{CC1}$	4.7 to 5.3	V
	$V_{CC2}$	7.0 to 8.0	

### ■ Electrical Characteristics at $T_a = 25^\circ\text{C}$

Parameter	Symbol	Conditions	Min	Typ	Max	Unit
DC						
$V_{CC1}$ -system current consumption	$I_{TOTAL1}$	—	29	—	43	mA
$V_{CC2}$ -system current consumption	$I_{TOTAL2}$	—	6.0	—	14.0	mA
Pin 2 voltage	$V_2$	—	1.8	—	2.2	V
Pin 40 voltage	$V_{40}$	—	2.7	—	3.3	V
Chrominance system						
R-Y standard gain	$G_{RY}$	SG3 ( $Y_y = -17$ dB, $Y_s = 0$ V[p-p], NTSC), ch.1 = "C0"	9.5	—	14.5	dB
R-Y/G-Y relative gain	$G_{RYGY}$	SG3 ( $Y_y = -17$ dB, $Y_s = 0$ V[p-p], NTSC), ch.1 = "C0"	-8.0	—	-4.0	dB
B-Y standard gain	$G_{BY}$	SG3 ( $Y_y = -17$ dB, $Y_s = 0$ V[p-p], NTSC), ch.1 = "C0"	9.5	—	14.5	dB
B-Y/G-Y relative gain	$G_{BYGY}$	SG3 ( $Y_y = -17$ dB, $Y_s = 0$ V[p-p], NTSC), ch.1 = "C0"	-20.5	—	-12.5	dB
High-level APC pull-in	$AP_H$	SG5 (4.43 MHz + 520 Hz, PAL)	500	—	540	Hz
Low-level APC pull-in	$AP_L$	SG5 (4.43 MHz - 520 Hz, PAL)	-540	—	-500	Hz
ACC output characteristic 1	$G_{ACC1}$	SG5 (0 dB, 6 dB, NTSC), ch.1 = "80"	-1.0	—	1.0	dB
ACC output characteristic 2	$G_{ACC2}$	SG5 (0 dB, 6 dB, NTSC), ch.1 = "80"	-1.0	—	1.0	dB
Chrominance killer characteristic 1	$V_{KILL1}$	SG5 (-30 dB, NTSC) ch.1 = "80", ch.2 = "80", ch.5 = "FF"	400	—	—	mV[p-p]
Chrominance killer characteristic 2	$V_{KILL2}$	SG5 (-50 dB, NTSC) ch.1 = "80", ch.2 = "80", ch.5 = "FF"	—	—	600	mV[p-p]

**■ Electrical Characteristics at  $T_a = 25^\circ\text{C}$  (continued)**

Parameter	Symbol	Conditions	Min	Typ	Max	Unit
Y-system						
Sharpness control characteristic	$G_{SH}$	SG1 (2 MHz, NTSC) ch.1 = "80", ch.9 = "80"/"FF"	1.0	—	—	dB
Sharpness frequency characteristic 1	$f_{SH1}$	SG1 (100 kHz/2 MHz, NTSC) ch.1 = "80"	3.5	—	—	dB
R-ch. contrast adjustment range 1	$CTR_{R1}$	SG3 (NTSC), ch.1 = "E0", ch.2 = "40" ch.5 = "80", ch.12/13/14 = "FF" ch.8/10/11 adjustment ch.15 = "C0"/"FF"	1.5	—	—	dB
G-ch. contrast adjustment range 1	$CTR_{G1}$	SG3 (NTSC), ch.1 = "E0", ch.2 = "40" ch.5 = "80", ch.12/13/14 = "FF" ch.8/10/11 adjustment ch.15 = "C0"/"FF"	1.5	—	—	dB
B-ch. contrast adjustment range 1	$CTR_{B1}$	SG3 (NTSC), ch.1 = "E0", ch.2 = "40" ch.5 = "80", ch.12/13/14 = "FF" ch.8/10/11 adjustment ch.15 = "C0"/"FF"	1.5	—	—	dB
R-ch. contrast adjustment range 2	$CTR_{R2}$	SG3 (NTSC), ch.1 = "E0", ch.2 = "40" ch.5 = "80", ch.12/13/14 = "FF" ch.8/10/11 adjustment ch.15 = "C0"/"80"	—	—	-5.2	dB
G-ch. contrast adjustment range 2	$CTR_{G2}$	SG3 (NTSC), ch.1 = "E0", ch.2 = "40" ch.5 = "80", ch.12/13/14 = "FF" ch.8/10/11 adjustment ch.15 = "C0"/"80"	—	—	-5.2	dB
B-ch. contrast adjustment range 2	$CTR_{B2}$	SG3 (NTSC), ch.1 = "E0", ch.2 = "40" ch.5 = "80", ch.12/13/14 = "FF" ch.8/10/11 adjustment ch.15 = "C0"/"80"	—	—	-5.2	dB
R-ch. pedestal amplitude minimum	$V_{PEDRmin}$	SG3 (NTSC), ch.1 = "E0", ch.2 = "40" ch.5 = "80", ch.12/13/14 = "FF" ch.8/10/11 adjustment, ch.8 = "FF" ch.15 = "C0"	—	—	2.0	V[p-p]
G-ch. pedestal amplitude minimum	$V_{PEDGmin}$	SG3 (NTSC), ch.1 = "E0", ch.2 = "40" ch.5 = "80", ch.12/13/14 = "FF" ch.8/10/11 adjustment, ch.8 = "FF" ch.15 = "C0"	—	—	2.0	V[p-p]
B-ch. pedestal amplitude minimum	$V_{PEDBmin}$	SG3 (NTSC), ch.1 = "E0", ch.2 = "40" ch.5 = "80", ch.12/13/14 = "FF" ch.8/10/11 adjustment, ch.8 = "FF" ch.15 = "C0"	—	—	2.0	V[p-p]

**■ Electrical Characteristics at  $T_a = 25^\circ\text{C}$  (continued)**

Parameter	Symbol	Conditions	Min	Typ	Max	Unit
Y-system (continued)						
R-ch. pedestal amplitude maximum	$V_{\text{PEDRmax}}$	SG3 (NTSC), ch.1 = "E0", ch.2 = "40" ch.5 = "80", ch.12/13/14 = "FF" ch.8/10/11 adjustment, ch.8 = "00" ch.15 = "C0"	3.0	—	—	V[p-p]
G-ch. pedestal amplitude maximum	$V_{\text{PEDGmax}}$	SG3 (NTSC), ch.1 = "E0", ch.2 = "40" ch.5 = "80", ch.12/13/14 = "FF" ch.8/10/11 adjustment, ch.8 = "00" ch.15 = "C0"	3.0	—	—	V[p-p]
B-ch. pedestal amplitude maximum	$V_{\text{PEDBmax}}$	SG3 (NTSC), ch.1 = "E0", ch.2 = "40" ch.5 = "80", ch.12/13/14 = "FF" ch.8/10/11 adjustment, ch.8 = "00" ch.15 = "C0"	3.0	—	—	V[p-p]
G-ch. output DC voltage	$V_{\text{GDC}}$	SG3 (NTSC), ch.1 = "E0", ch.2 = "40" ch.5 = "80", ch.12 = "FF", ch.14 = "40" ch.8/10/11 adjustment, ch.15 = "C0"	2.2	—	2.5	V[p-p]
R-ch. gamma characteristic 1	$G_{\text{GAMR1}}$	SG3 (NTSC), ch.1 = "E0", ch.2 = "40" ch.5 = "80", ch.12 = "FF", ch.14 = "40" ch.8/10/11/15 adjustment	-8.5	—	-3.5	dB
G-ch. gamma characteristic 1	$G_{\text{GAMG1}}$	SG3 (NTSC), ch.1 = "E0", ch.2 = "40" ch.5 = "80", ch.12 = "FF", ch.14 = "40" ch.8/10/11/15 adjustment	-8.5	—	-3.5	dB
B-ch. gamma characteristic 1	$G_{\text{GAMB1}}$	SG3 (NTSC), ch.1 = "E0", ch.2 = "40" ch.5 = "80", ch.12 = "FF", ch.14 = "40" ch.8/10/11/15 adjustment	-8.5	—	-3.5	dB
R-ch. gamma characteristic 2	$G_{\text{GAMR2}}$	SG3 (NTSC), ch.1 = "E0", ch.4 = "40" ch.5 = "80", ch.12 = "FF", ch.14 = "40" ch.8/10/11/15 adjustment ch.13 = "80"/"FF"	-8.2	—	—	dB
G-ch. gamma characteristic 2	$G_{\text{GAMG2}}$	SG3 (NTSC), ch.1 = "E0", ch.4 = "40" ch.5 = "80", ch.12 = "FF", ch.14 = "40" ch.8/10/11/15 adjustment ch.13 = "80"/"FF"	-8.2	—	—	dB
B-ch. gamma characteristic 2	$G_{\text{GAMB2}}$	SG3 (NTSC), ch.1 = "E0", ch.4 = "40" ch.5 = "80", ch.12 = "FF", ch.14 = "40" ch.8/10/11/15 adjustment ch.13 = "80"/"FF"	-8.2	—	—	dB
R-ch. gamma characteristic 3	$G_{\text{GAMR3}}$	SG3 (NTSC), ch.1 = "E0", ch.2 = "40" ch.5 = "80", ch.12 = "FF", ch.14 = "40" ch.8/10/11/15 adjustment ch.13 = "80"/"60"	-3.5	—	0.5	dB

**■ Electrical Characteristics at  $T_a = 25^\circ\text{C}$  (continued)**

Parameter	Symbol	Conditions	Min	Typ	Max	Unit
Y-system (continued)						
G-ch. gamma characteristic 3	$G_{\text{GAMG3}}$	SG3 (NTSC), ch.1 = "E0", ch.2 = "40" ch.5 = "80", ch.12 = "FF", ch.14 = "40" ch.8/10/11/15 adjustment ch.13 = "80"/"60"	-3.5	—	0.5	dB
B-ch. gamma characteristic 3	$G_{\text{GAMB3}}$	SG3 (NTSC), ch.1 = "E0", ch.2 = "40" ch.5 = "80", ch.12 = "FF", ch.14 = "40" ch.8/10/11/15 adjustment ch.13 = "80"/"60"	-3.5	—	0.5	dB
R-ch. white limiter low-level	$V_{\text{WRRL}}$	SG3 (NTSC), ch.1 = "E0", ch.2 = "40" ch.5 = "80", ch.12 = "00", ch.14 = "40" ch.8/10/11/15 adjustment ch.15 = "FF"	—	—	3.0	V[p-p]
G-ch. white limiter low-level	$V_{\text{WRGL}}$	SG3 (NTSC), ch.1 = "E0", ch.2 = "40" ch.5 = "80", ch.12 = "00", ch.14 = "40" ch.8/10/11/15 adjustment ch.15 = "FF"	—	—	3.0	V[p-p]
B-ch. white limiter low-level	$V_{\text{WRBL}}$	SG3 (NTSC), ch.1 = "E0", ch.2 = "40" ch.5 = "80", ch.12 = "00", ch.14 = "40" ch.8/10/11/15 adjustment ch.15 = "FF"	—	—	3.0	V[p-p]
R-ch. white limiter high-level	$V_{\text{WRRH}}$	SG3 (NTSC), ch.1 = "E0", ch.2 = "40" ch.5 = "80", ch.12 = "FF", ch.14 = "40" ch.8/10/11/15 adjustment ch.15 = "FF"	3.2	—	—	V[p-p]
G-ch. white limiter high-level	$V_{\text{WRGH}}$	SG3 (NTSC), ch.1 = "E0", ch.2 = "40" ch.5 = "80", ch.12 = "FF", ch.14 = "40" ch.8/10/11/15 adjustment ch.15 = "FF"	3.2	—	—	V[p-p]
B-ch. white limiter high-level	$V_{\text{WRBH}}$	SG3 (NTSC), ch.1 = "E0", ch.2 = "40" ch.5 = "80", ch.12 = "FF", ch.14 = "40" ch.8/10/11/15 adjustment ch.15 = "FF"	3.2	—	—	V[p-p]
R-ch. black limiter low-level	$V_{\text{BRRL}}$	SG3 (NTSC), ch.1 = "E0", ch.2 = "40" ch.5 = "80", ch.7 = "80", ch.12 = "FF" ch.14 = "40", ch.8/10/11/15 adjustment ch.8 = "00"	3.0	—	—	V
G-ch. black limiter low-level	$V_{\text{BRGL}}$	SG3 (NTSC), ch.1 = "E0", ch.2 = "40" ch.5 = "80", ch.7 = "80", ch.12 = "FF" ch.14 = "40", ch.8/10/11/15 adjustment ch.8 = "00"	3.0	—	—	V

■ Electrical Characteristics at  $T_a = 25^\circ\text{C}$  (continued)

Parameter	Symbol	Conditions	Min	Typ	Max	Unit
Y-system (continued)						
B-ch. black limiter low-level	$V_{BRBL}$	SG3 (NTSC), ch.1 = "E0", ch.2 = "40" ch.5 = "80", ch.7 = "80", ch.12 = "FF" ch.14 = "40", ch.8/10/11/15 adjustment ch.8 = "00"	3.0	—	—	V
R-ch. black limiter high-level	$V_{BRRH}$	SG3 (NTSC), ch.1 = "E0", ch.2 = "40" ch.5 = "80", ch.12 = "FF" ch.8/10/11/15 adjustment, ch.7 = "FF" ch.8 = "00", ch.14 = "40"	—	—	1.2	V
G-ch. black limiter high-level	$V_{BRGH}$	SG3 (NTSC), ch.1 = "E0", ch.2 = "40" ch.5 = "80", ch.12 = "FF" ch.8/10/11/15 adjustment, ch.7 = "FF" ch.8 = "00", ch.14 = "40"	—	—	1.2	V
B-ch. black limiter high-level	$V_{BRBH}$	SG3 (NTSC), ch.1 = "E0", ch.2 = "40" ch.5 = "80", ch.12 = "FF" ch.8/10/11/15 adjustment, ch.7 = "FF" ch.8 = "00", ch.14 = "40"	—	—	1.2	V
R-ch. $Y_S$ threshold 1	$V_{tYSR1}$	SG2 (NTSC), ch.1 = "E0", ch.2 = "40" ch.5 = "80", ch.12 = "FF", ch.14 = "40" ch.8/10/11/15 adjustment, Pin 16 = 1 V	0.8	—	—	V[p-p]
G-ch. $Y_S$ threshold 1	$V_{tYSG1}$	SG2 (NTSC), ch.1 = "E0", ch.2 = "40" ch.5 = "80", ch.12 = "FF", ch.14 = "40" ch.8/10/11/15 adjustment, Pin 16 = 1 V	0.8	—	—	V[p-p]
B-ch. $Y_S$ threshold 1	$V_{tYSB1}$	SG2 (NTSC), ch.1 = "E0", ch.2 = "40" ch.5 = "80", ch.12 = "FF", ch.14 = "40" ch.8/10/11/15 adjustment, Pin 16 = 1 V	0.8	—	—	V[p-p]
R-ch. $Y_S$ threshold 2	$V_{tYSR2}$	SG2 (NTSC), ch.1 = "E0", ch.2 = "40" ch.5 = "80", ch.12 = "FF", ch.14 = "40" ch.8/10/11/15 adjustment, Pin 16 = 4 V	—	—	0.5	V[p-p]
G-ch. $Y_S$ threshold 2	$V_{tYSG2}$	SG2 (NTSC), ch.1 = "E0", ch.2 = "40" ch.5 = "80", ch.12 = "FF", ch.14 = "40" ch.8/10/11/15 adjustment, Pin 16 = 4 V	—	—	0.5	V[p-p]
B-ch. $Y_S$ threshold 2	$V_{tYSB2}$	SG2 (NTSC), ch.1 = "E0", ch.2 = "40" ch.5 = "80", ch.12 = "FF", ch.14 = "40" ch.8/10/11/15 adjustment, Pin 16 = 4 V	—	—	0.5	V[p-p]
R-ch. black level	$CHR_{RB}$	SG2 (NTSC), ch.1 = "E0", ch.2 = "40" ch.5 = "80", ch.12 = "FF", ch.14 = "40" ch.8/10/11/15 adjustment, Pin 16 = SG7	-0.6	—	0.6	V
G-ch. black level	$CHR_{GB}$	SG2 (NTSC), ch.1 = "E0", ch.2 = "40" ch.5 = "80", ch.12 = "FF", ch.14 = "40" ch.8/10/11/15 adjustment, Pin 16 = SG7	-0.6	—	0.6	V
B-ch. black level	$CHR_{BB}$	SG2 (NTSC), ch.1 = "E0", ch.2 = "40" ch.5 = "80", ch.12 = "FF", ch.14 = "40" ch.8/10/11/15 adjustment, Pin 16 = SG7	-0.6	—	0.6	V

**■ Electrical Characteristics at  $T_a = 25^\circ\text{C}$  (continued)**

Parameter	Symbol	Conditions	Min	Typ	Max	Unit
Y-system (continued)						
R-ch. black level width	WCHR <sub>RB</sub>	SG2 (NTSC), ch.1 = "E0", ch.2 = "40" ch.5 = "80", ch.12 = "FF", ch.14 = "40" ch.8/10/11/15 adjustment, Pin 16 = SG7	2.25	—	3.75	$\mu\text{s}$
G-ch. black level width	WCHR <sub>GB</sub>	SG2 (NTSC), ch.1 = "E0", ch.2 = "40" ch.5 = "80", ch.12 = "FF", ch.14 = "40" ch.8/10/11/15 adjustment, Pin 16 = SG7	2.25	—	3.75	$\mu\text{s}$
B-ch. black level width	WCHR <sub>BB</sub>	SG2 (NTSC), ch.1 = "E0", ch.2 = "40" ch.5 = "80", ch.12 = "FF", ch.14 = "40" ch.8/10/11/15 adjustment, Pin 16 = SG7	2.25	—	3.75	$\mu\text{s}$
R-ch. CHR threshold 1	V <sub>tCHR1</sub>	SG2 (NTSC), ch.1 = "E0", ch.2 = "40" ch.5 = "80", ch.12 = "FF", ch.14 = "40" ch.8/10/11/15 adjustment, Pin 12 = 1 V	1.5	—	—	V[p-p]
G-ch. CHR threshold 1	V <sub>tCHG1</sub>	SG2 (NTSC), ch.1 = "E0", ch.2 = "40" ch.5 = "80", ch.12 = "FF", ch.14 = "40" ch.8/10/11/15 adjustment, Pin 13 = 1 V	1.5	—	—	V[p-p]
B-ch. CHR threshold 1	V <sub>tCHB1</sub>	SG2 (NTSC), ch.1 = "E0", ch.2 = "40" ch.5 = "80", ch.12 = "FF", ch.14 = "40" ch.8/10/11/15 adjustment, Pin 14 = 1 V	1.5	—	—	V[p-p]
R-ch. CHR threshold 2	V <sub>tCHR2</sub>	SG2 (NTSC), ch.1 = "E0", ch.2 = "40" ch.5 = "80", ch.12 = "FF", ch.14 = "40" ch.8/10/11/15 adjustment, Pin 12 = 4 V	3.0	—	—	V[p-p]
G-ch. CHR threshold 2	V <sub>tCHG2</sub>	SG2 (NTSC), ch.1 = "E0", ch.2 = "40" ch.5 = "80", ch.12 = "FF", ch.14 = "40" ch.8/10/11/15 adjustment, Pin 13 = 4 V	3.0	—	—	V[p-p]
B-ch. CHR threshold 2	V <sub>tCHB2</sub>	SG2 (NTSC), ch.1 = "E0", ch.2 = "40" ch.5 = "80", ch.12 = "FF", ch.14 = "40" ch.8/10/11/15 adjustment, Pin 14 = 4 V	3.0	—	—	V[p-p]
R-ch. white level	CHR <sub>RW</sub>	SG2 (NTSC), ch.1 = "E0", ch.2 = "40" ch.5 = "80", ch.12 = "FF", ch.14 = "40" ch.8/10/11/15 adjustment, Pin 12 = SG7	2.0	—	—	V[p-p]
G-ch. white level	CHR <sub>GW</sub>	SG2 (NTSC), ch.1 = "E0", ch.2 = "40" ch.5 = "80", ch.12 = "FF", ch.14 = "40" ch.8/10/11/15 adjustment, Pin 13 = SG7	2.0	—	—	V[p-p]
B-ch. white level	CHR <sub>BW</sub>	SG2 (NTSC), ch.1 = "E0", ch.2 = "40" ch.5 = "80", ch.12 = "FF", ch.14 = "40" ch.8/10/11/15 adjustment, Pin 14 = SG7	2.0	—	—	V[p-p]
R-ch. white level width	WCHR <sub>RW</sub>	SG2 (NTSC), ch.1 = "E0", ch.2 = "40" ch.5 = "80", ch.12 = "FF", ch.14 = "40" ch.8/10/11/15 adjustment, Pin 12 = SG7	2.25	—	3.75	$\mu\text{s}$
G-ch. white level width	WCHR <sub>GW</sub>	SG2 (NTSC), ch.1 = "E0", ch.2 = "40" ch.5 = "80", ch.12 = "FF", ch.14 = "40" ch.8/10/11/15 adjustment, Pin 13 = SG7	2.25	—	3.75	$\mu\text{s}$

■ Electrical Characteristics at  $T_a = 25^\circ\text{C}$  (continued)

Parameter	Symbol	Conditions	Min	Typ	Max	Unit
Y-system (continued)						
B-ch. white level width	$V_{CHR_{BW}}$	SG2 (NTSC), ch.1 = "E0", ch.2 = "40" ch.5 = "80", ch.12 = "FF", ch.14 = "40" ch.8/10/11/15 adjustment, Pin 14 = SG7	2.25	—	3.75	$\mu\text{s}$
R-ch. RGB2 relative amplitude	$V_{RGB2R}$	SG2 (NTSC), ch.1 = "A0" ch.5 = "80", ch.12 = "FF", ch.14 = "40" ch.8/10/11/15 adjustment, ch.3 = "40" ch.6 = "40", Pin 42 = 4 V	-0.45	—	0.45	V[p-p]
B-ch. RGB2 relative amplitude	$V_{RGB2B}$	SG2 (NTSC), ch.1 = "A0" ch.5 = "80", ch.12 = "FF", ch.14 = "40" ch.8/10/11/15 adjustment, ch.3 = "40" ch.6 = "40", Pin 42 = 4 V	-0.45	—	0.45	V[p-p]
Synchronous system						
Horizontal sync. pulse low-level	$V_{HDL}$	—	—	—	0.4	V
Horizontal sync. pulse amplitude	$V_{HD}$	—	4.0	—	—	V[p-p]
Horizontal sync. pulse width	$t_{HD}$	—	4.86	—	6.86	$\mu\text{s}$
Vertical sync. pulse low-level	$V_{VDL}$	—	—	—	0.4	V
Vertical sync. pulse amplitude	$V_{VD}$	—	4.0	—	—	V[p-p]
Horizontal sync. separation pulse high-level	$V_{HSSH}$	SG2 (NTSC)	4.0	—	—	V
Horizontal sync. separation pulse amplitude	$V_{HSS}$	SG2 (NTSC)	4.0	—	—	V[p-p]
Horizontal sync. separation pulse width	$t_{HSS}$	SG2 (NTSC)	3.8	—	5.8	$\mu\text{s}$

■ Electrical Characteristics at  $T_a = 25^\circ\text{C}$  (continued)







• Testing signal waveform

Signal name	Signal waveform
<p>SG1 (Sine wave video signal)</p>	
<p>SG2 (White signal)</p>	
<p>SG3 (10-step wave)</p>	
<p>SG5 (Color bar chrominance signal)</p>	<p>Burst amplitude = 300 mV[p-p] Chrominance amplitude = 600 mV[p-p]</p> <p>Burst, chrominance frequency NTSC = 3.579 545 MHz PAL = 4.433 619 MHz</p>
<p>SG7 (Character pulse)</p>	

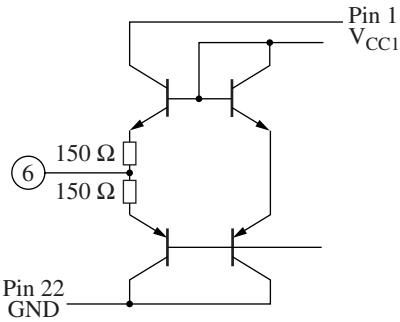
■ Terminal Equivalent Circuits

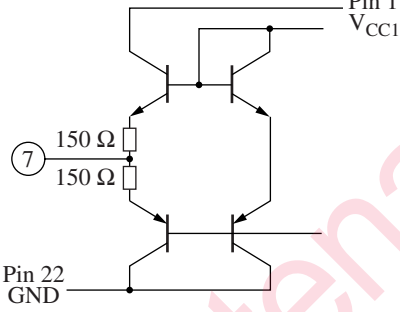
Pin No.	Equivalent circuit	Description	Voltage · Waveform
1	—	V <sub>CC1</sub> : 5.0 V-system power supply pin Supply current 40 mA typ.	—
2		V <sub>REF</sub> : Reference voltage output pin 2.0 V typ.	—
3		R-ch. det.: R-ch. clamping capacitor coupling pin	—
4		G-ch. det.: G-ch. clamping capacitor coupling pin	—
5		B-ch. det.: B-ch. clamping capacitor coupling pin	—

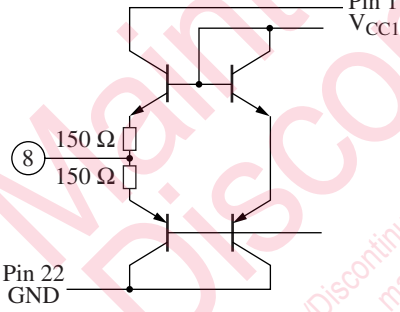
■ Terminal Equivalent Circuits (continued)

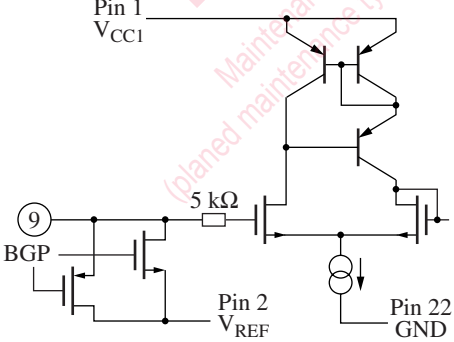
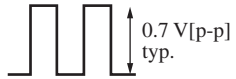
Pin No.	Equivalent circuit	Description	Voltage · Waveform
6		Dec.R-out: Output pin of R signal de-modulated from video signal	
7		Dec.G-out: Output pin of G signal de-modulated from video signal	
8		Dec.B-out: Output pin of B signal de-modulated from video signal	
9		R-in 1: Analog R signal input	<p>Analog R signal</p> 

Terminal Equivalent Circuits (continued)

Pin No.	Equivalent circuit	Description	Voltage · Waveform
10		G-in 1: Analog G signal input	Analog G signal 
11		B-in 1: Analog B signal input	Analog B signal 
12		R-in 2: Character insertion signal input for R-ch., supporting analog and digital OSD.	Analog OSD  Digital OSD 
13		G-in 2: Character insertion signal input for G-ch., supporting analog and digital OSD.	Analog OSD  Digital OSD 

■ Terminal Equivalent Circuits (continued)

Pin No.	Equivalent circuit	Description	Voltage · Waveform
14		<p>B-in 2: Character insertion signal input for B-ch., supporting analog and digital OSD.</p>	<p>Analog OSD</p> <p>Digital OSD</p>
15		<p>BLK: Black level indication control signal input pin</p>	
16		<p>YS: Character picking up signal input</p>	
17		<p>B-out: B signal output pin</p>	
18		<p>B-ch. AVE det.: B-ch. output DC feedback detection pin</p>	

■ Terminal Equivalent Circuits (continued)

Pin No.	Equivalent circuit	Description	Voltage · Waveform
19		<p>G-out: G signal output pin</p>	
20	—	<p>V<sub>CC2</sub>: 7.5 V system power supply Supply current 12 mA typ.</p>	—
21		<p>AVE: R,G,B output DC reference voltage pin</p>	—
22	—	<p>GND 2: Drive circuits system GND</p>	—
23		<p>G-ch.AVE det.: G-ch. output DC feedback detection pin</p>	—
24		<p>R-out: R signal output pin</p>	

Terminal Equivalent Circuits (continued)

Pin No.	Equivalent circuit	Description	Voltage · Waveform
25		<p>R-ch.AVE det.: R-ch. output DC feedback detection pin</p>	—
26		<p>Common out: Voltage output pin for common. Output impedance; Approx. 150 Ω</p>	
27		<p>Test mode: Logic test mode start signal input pin; "Open" or "GND" normally</p>	High or Low
28		<p>Test CLK: Logic test pulse input pin; "Open" or "GND" normally</p>	High or Low
29		<p>Field: Field identifying signal output pin</p>	<p>Output waveform</p>

■ Terminal Equivalent Circuits (continued)

Pin No.	Equivalent circuit	Description	Voltage · Waveform
30		<p>HSS: Composite synchronous signal output pin</p>	<p>Output waveform</p>
31		<p>VD: Vertical synchronous signal output pin</p>	<p>Output waveform</p>
32		<p>HD: Horizontal synchronous signal output pin</p>	<p>Output waveform</p>
33		<p>PWM: PWM signal output pin</p>	<p>Output waveform</p>
34		<p>RST: Capacitor coupling pin for power-on reset</p>	<p>—</p>

■ Terminal Equivalent Circuits (continued)

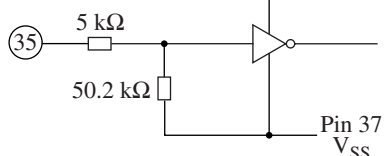
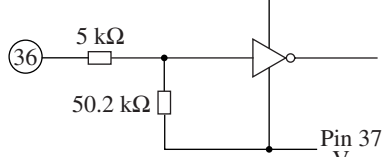
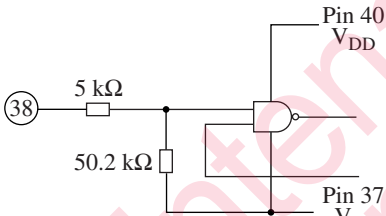
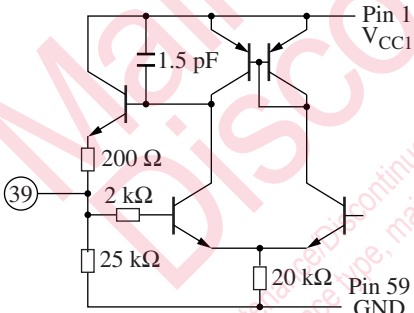
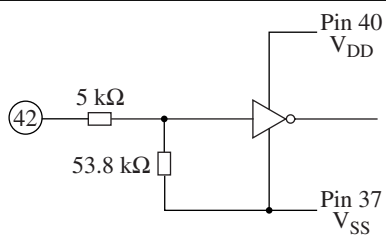
Pin No.	Equivalent circuit	Description	Voltage · Waveform
35		VDB in: Vertical synchronous pulse input pin	High or Low
36		Ext. pol.: 1H reverse signal input pin	High or Low
37	—	V <sub>SS</sub> : MOS system GND	—
38		Clamp in: Clamp pulse input pin Valid only in the external clamp mode. Positive polarity input.	High or Low
39		DAC mon.: DAC DC voltage output pin	DC
40	—	V <sub>DD</sub> : Capacitor connection pin for MOS part power supply. 3.0 V typ.	—
41	—	GND 3: Pulse system GND	—
42		PRGB: Analog OSD signal input Mode start-up signal input pin Valid only in the analog OSD mode High = Analog OSD start up	High or Low

■ Terminal Equivalent Circuits (continued)

Pin No.	Equivalent circuit	Description	Voltage · Waveform
43		<p>AFC det.: AFC filter connection pin Input impedance; 100 kΩ or more</p>	
44		<p>H f<sub>o</sub>: VCO oscillation frequency adjusting resistor connection pin</p>	<p>—</p>
45		<p>HSS in: H-sync. input pin Separates a sync signal from luminance signal (video signal)</p>	<p>Input signal example: Video signal</p>
46		<p>Bus-ch: Switching pin for serial three-wire control/I<sup>2</sup>C bus control High = I<sup>2</sup>C bus Open or Low = Serial three-wire control</p>	<p>High or Low</p>
47		<p>DAC: Serial clock input pin</p>	

■ Terminal Equivalent Circuits (continued)

Pin No.	Equivalent circuit	Description	Voltage · Waveform
48		DAT: Serial data input pin	
49		LEN: Load pulse input pin, also works as the slave address conversion pin in the I <sup>2</sup> C bus mode. High = "88" Low = "8A"	
50		ACC det.: ACC capacitor connecting pin, adjusting the amplitude of a burst signal automatically	—
51		C in: Chrominance signal input pin Input chrominance signal (video signal)	<p>Input signal example: Video signal</p>
52		L.det.: Capacitor coupling pin for the horizontal unlock detecting circuit	—

■ Terminal Equivalent Circuits (continued)

Pin No.	Equivalent circuit	Description	Voltage · Waveform
53		<p>Kill det.: Killer capacitor coupling pin. To prevent degradation of image in a small amplitude of a burst signal, this pin stops a chrominance signal and the mode changes to black and white mode.</p>	—
54		<p>APC det.: APC capacitor coupling pin. Matching the phase of a crystal oscillation to that of burst signal.</p>	—
55		<p>VXOI : Crystal oscillator connecting pin The pair with pin 56</p>	<p>NTSC 3.58 MHz PAL 4.43 MHz</p>
56		<p>VXOO: Crystal oscillator connecting pin The pair with pin 55 Output impedance; Approximately 100 Ω</p>	<p>NTSC 3.58 MHz PAL 4.43 MHz</p>

■ Terminal Equivalent Circuits (continued)

Pin No.	Equivalent circuit	Description	Voltage · Waveform
57		<p>Y-det.: Capacitor coupling pin for luminance signal clamping</p>	—
58		<p>Trap: Trap connecting pin Trapping a chrominance signal by connecting external inductor and capacitor. Not necessary in case that an input signal is a component.</p>	—
59	—	<p>GND 3: GND for chrominance and luminance signal process blocks</p>	—
60		<p>Y-in: Luminance signal input pin Input luminance signal (video signal)</p>	<p>Input signal example: Video signal</p>
61		<p>R-Y out: R-Y signal output pin, demodulated from a video signal</p>	<p>R-Y signal</p>

### Terminal Equivalent Circuits (continued)

Pin No.	Equivalent circuit	Description	Voltage · Waveform
62		<p>B-Y out: B-Y signal output pin, demodulated from a video signal</p>	<p>B-Y signal</p>
63		<p>R-Y in: R-Y signal input pin in a color difference mode and in standard PAL.</p>	<p>R-Y signal</p>
64		<p>B-Y in: B-Y signal input pin in a color difference mode and in standard PAL.</p>	<p>B-Y signal</p>

### Usage Notes

- Since the following pins are low in a static electricity breakdown level, be cautious on use.

Pin 27 breakdown level

$C = 200 \text{ pF}$

+ 200 V to 210 V

Pin 35 breakdown level

$C = 200 \text{ pF}$

+ 180 V to 190 V

- Evaluated throughly on the application of this device in PAL.

■ Technical Data

1. Serial interface description

1) Serial data control

In addition to its serial control by the conventional three-wire method, the AN2526FH can be controlled by the I<sup>2</sup>C bus. The transmission method is selected by the voltage to be applied to Pin 46.

Three-wire control mode: Pin 46 = Low (connect to GND)

I<sup>2</sup>C bus mode: Pin 46 = High (Pin 41: connect to V<sub>DD</sub>)

It is recommended that the serial data is transferred during a vertical blanking period.

2) Three-wire control mode

A serial data is of three-line system communicating three kinds of signals of data, shift clock and load pulse independently. The data to be communicated is made up by 12 bits in total of address (4 bits) and data (8 bits). The DAC is composed of four blocks of serial-parallel conversion, address decoder, data latch and ladder resistors, enabling to control 16 channels in total. Further, the mode setting such as the input signal switching is done by a serial data to reduce the pin count.

(1) Serial data format

D11	D10	D9	D8	D7	D6	D5	D4	D3	D2	D1	D0
Address block				Data block							

(2) Serial data input timing chart

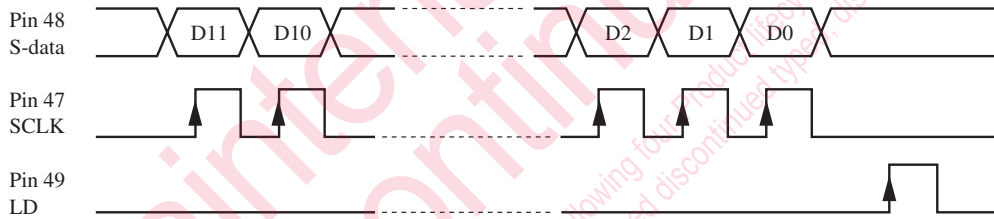

Timing chart expanded diagram

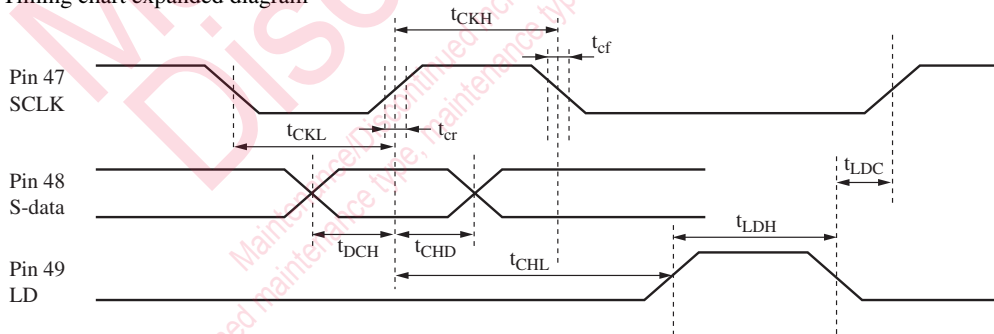

## ■ Technical Data (continued)

### 1. Serial interface description (continued)

#### 2) Three-wire control mode (continued)

##### (2) Serial data input timing chart (continued)

Parameter	Symbol	Min	Max	Unit
Clock low-level pulse width	$t_{CKL}$	500	—	ns
Clock high-level pulse width	$t_{CKH}$	500	—	ns
Clock rise time	$t_{cr}$	—	20	ns
Clock fall time	$t_{cf}$	—	20	ns
Data setup time	$t_{DCH}$	30	—	ns
Data hold time	$t_{CHD}$	60	—	ns
Load setup time	$t_{CHL}$	200	—	ns
Load hold time	$t_{LDC}$	100	—	ns
Load high-level pulse width	$t_{LDH}$	500	—	ns

##### (3) Mode setting channel bits table

D11	D10	D9	D8	Selection-ch.	EVR control function	Number of bits
0	0	0	0	0	Vertical sync. signal output position	3
1	0	0	0	1	Horizontal sync. signal output position	5
0	1	0	0	2	PWM duty	6
1	1	0	0	3	Common pulse amplitude	7
0	0	1	0	4	Y-gain	8
1	0	1	0	5	Color gain	7
0	1	1	0	6	Hue	7
1	1	1	0	7	Black-limiter level	8
0	0	0	1	8	Brightness	8
1	0	0	1	9	Y-aperture gain	8
0	1	0	1	10	R-ch. sub-brightness	8
1	1	0	1	11	B-ch. sub-brightness	8
0	0	1	1	12	White peak limiter level	8
1	0	1	1	13	Gamma-1 Knee level	8
0	1	1	1	14	Gamma-2 Knee level	8
1	1	1	1	15	RGB contrast	7

A variety of mode-settings for the channels for 8 bits or less is made by using the data of the data block.

The contents of each mode setting are shown next.

■ Technical Data (continued)

1. Serial interface description (continued)

2) Three-wire control mode (continued)

(3) Mode setting channel bits table (continued)

- ch.0: Vertical sync. output position adjustment

D11	D10	D9	D8	D7	D6	D5	D4 to D3	D2	D1	D0
				EXCHF	FIXHD	BOSC	Hor. PLL start position adjustment			
0	0	0	0	—	—	0	Automatic switching			
				—	—	1	263H/313H fixed (NTSC/PAL)			
				—	0	HD/VD output timing is serially variable				
				—	1	HD/VD output timing fixed				
				0	Odd number field: Advanced phase					
				1	Even number field: Advanced phase					

<Vertical sync. output timing adjusting range>

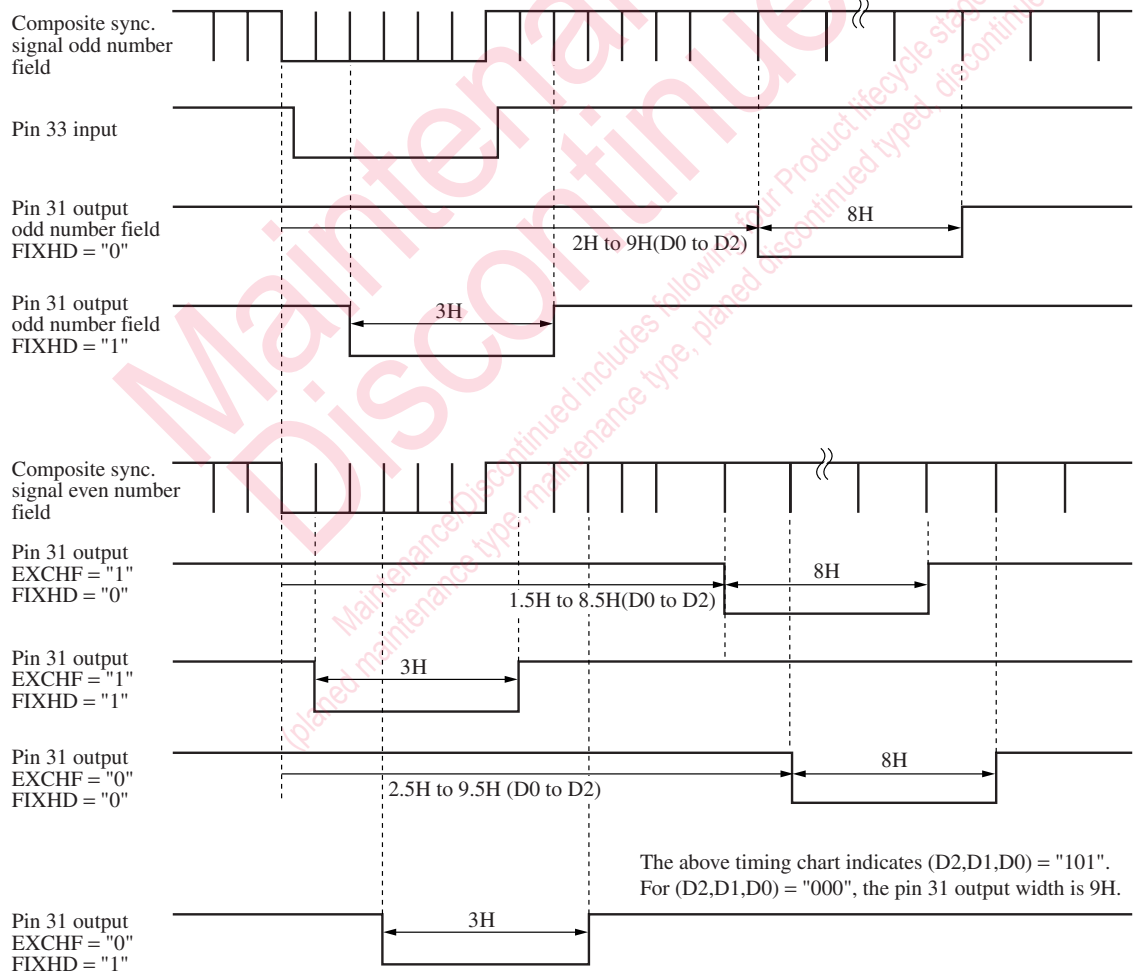

The pin 31 timing is synchronous with the pin 33 input timing.  
The above timing chart is just for reference.

■ Technical Data (continued)

1. Serial interface description (continued)

2) Three-wire control mode (continued)

(3) Mode setting channel bits table (continued)

- ch.0: (continued)

<Horizontal PLL start position adjustment range>

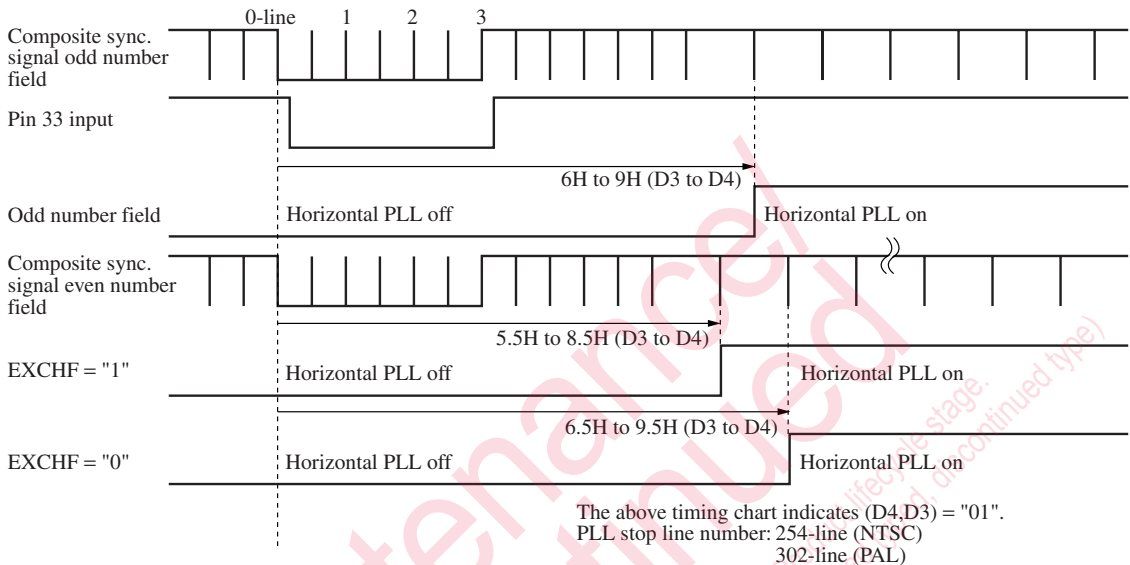

• ch.1: Horizontal sync. output position adjustment

D11	D10	D9	D8	D7 V Mode	D6 YUV	D5 RGB	D4	D3	D2	D1	D0
1	0	0	0	—	—	0	Video signal input display mode				
				—	—	1	Analog RGB input display mode				
				—	0	Chrominance signal input mode					
				—	1	Color-difference signal input mode					
				0	PAL						
				1	NTSC						

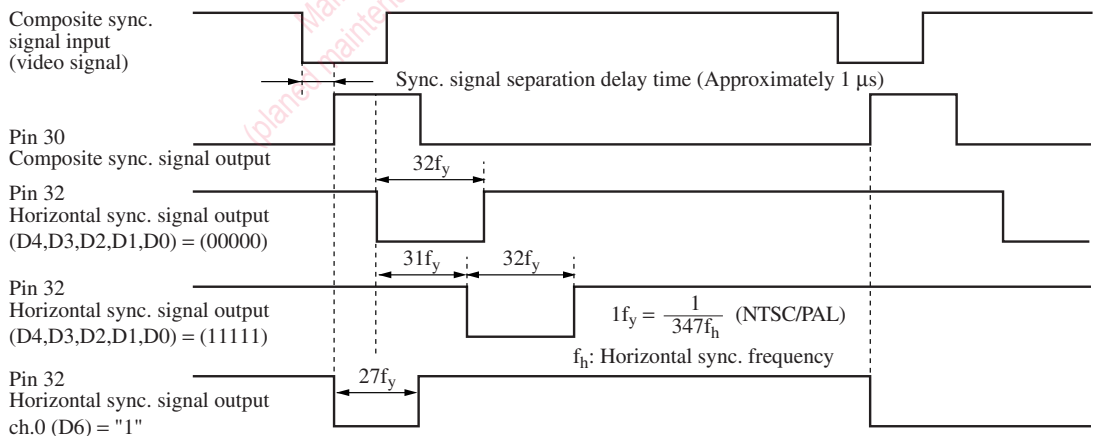

■ Technical Data (continued)

1. Serial interface description (continued)

2) Three-wire control mode (continued)

(3) Mode setting channel bits table (continued)

- ch.1: Horizontal sync. output position adjustment (continued)

The delay time of pin 30 output to video signal is likely to vary according to an external constant connected to pin 45. For an external constant, the characteristics in weak electric field must be evaluated adequately. Though the horizontal sync. signal output adjustment range is designed by referring to the center of pin 30 output pulse, there would be some error according to VCO free-run frequency.

- ch.2: PWM duty adjustment

D11	D10	D9	D8	D7 P mode	D6 YC mode	D5	D4	D3	D2	D1	D0
0	1	0	0	—	0	Composite input mode					
					1	Component input mode					
				0	Standard PAL mode						
				1	Quasi PAL/NTSC mode						

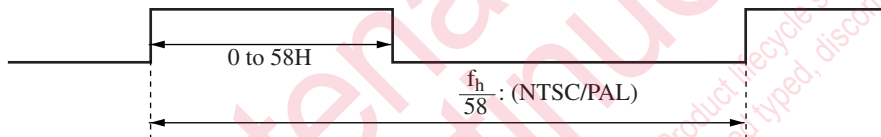

Note that adjustment characteristics come to discontinuation around max. duty.

- (D5,D4,D3,D2,D1,D0) = (000000):  $t_w = 1H$
- = (000001):  $t_w = 3H$
- = (000010):  $t_w = 4H$
- = (110110):  $t_w = 56H$
- = (110111):  $t_w = 56H$
- = (111000):  $t_w = 0H$
- = (111001):  $t_w = 58H$

- ch.3: Common pulse amplitude adjustment

D11	D10	D9	D8	D7 OSD	D6	D5	D4	D3	D2	D1	D0
1	1	0	0	0	Analog OSD signal input mode						
				1	Digital OSD signal input mode						

- ch.5: Color gain adjustment

D11	D10	D9	D8	D7 HTS	D6	D5	D4	D3	D2	D1	D0
1	0	1	0	0	1H reverse inhibit mode						
				1	1H reverse mode						

## ■ Technical Data (continued)

### 1. Serial interface description (continued)

#### 2) Three-wire control mode (continued)

##### (3) Mode setting channel bits table (continued)

###### • ch.6: Hue adjustment

D11	D10	D9	D8	D7 CP	D6	D5	D4	D3	D2	D1	D0
0	1	1	0	0	External clamp pulse input mode						
				1	Internal clamp (pedestal) mode						

###### • ch.9: Y-aperture gain adjustment

D11	D10	D9	D8	D7	D6	D5	D4	D3	D2	D1	D0
1	0	0	1	00h, 01h: Test mode							

###### • ch.15: RGB contrast adjustment

D11	D10	D9	D8	D7 POL mode	D6	D5	D4	D3	D2	D1	D0
1	1	1	1	0	Internal POL 1H reverse mode						
				1	External POL 1H reverse mode						

### 3) I<sup>2</sup>C bus control mode

A serial data is capable of transferring 9-bit unit of 8-bit transfer data and 1-bit answering data using two kinds of signal lines of data and shift clock.

When a slave address after setting a start condition matches the address on the IC side, you can receive the data to be transmitted from then. Once the stop condition is set up, the next transmitting data will be ignored until the start condition is set up.

There are two kinds of transfer mode: an auto-increment mode which does not transmit subaddress, and data upgrade mode which transmits sub-address + data by 2 bytes.

The typical models of communication sequence are shown below:

#### (1) Start condition

When the S-data changes from high level to low level at SCLK = high level, a data receiving mode becomes available.

#### (2) Slave address transfer

The slave address of the AN2526FH is 88h at pin 49 = high level and 8Ah at pin 49 = low level.

When you use the slave address at 88h, 10h and 11h are prohibited on the application.

When you use the slave address at 8Ah, 14h and 15h are prohibited on the application.

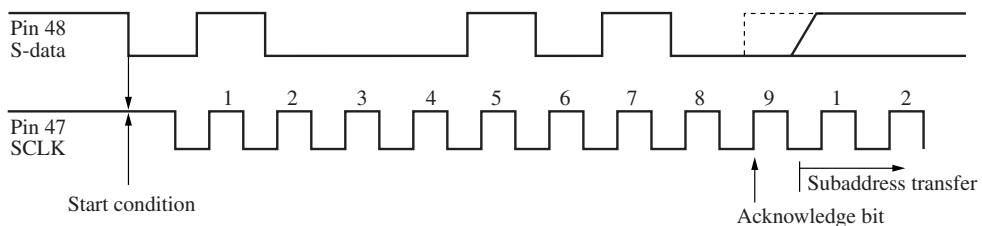

■ Technical Data (continued)

1. Serial interface description (continued)

3) I<sup>2</sup>C bus control mode (continued)

(3) Subaddress transfer

When a data transfer mode bit is 0, all the serial data columns transferred until a stop condition is set is regarded as the data block.

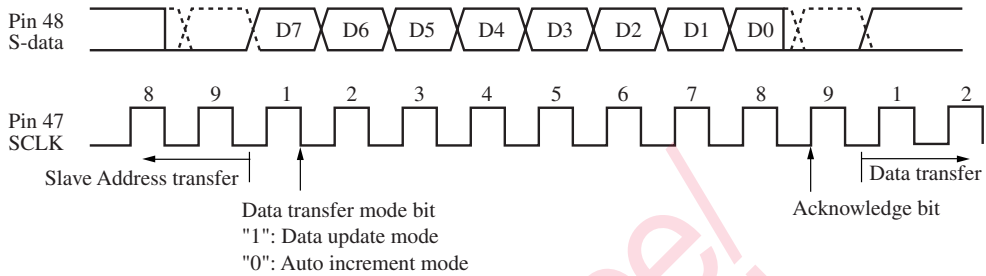

(4) Data transfer

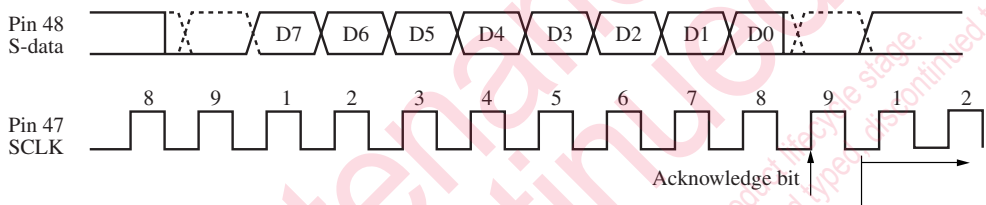

At auto increment mode: Data transfer  
At data update mode: Subaddress transfer

(5) Stop condition

When S-data changes from low level to high level at SCLK = high level, data reception is halted.

(6) Pulse timing

Timing chart expanded diagram

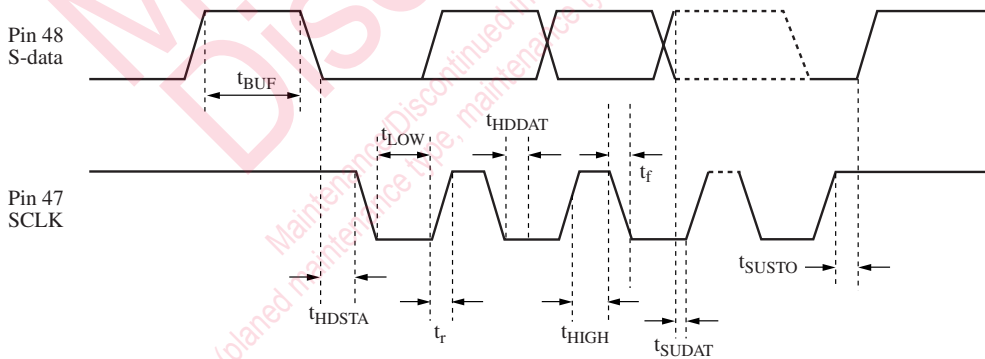

## ■ Technical Data (continued)

### 1. Serial interface description (continued)

#### 3) I<sup>2</sup>C bus control mode (continued)

##### (6) Pulse timing (continued)

Parameter	Symbol	Min	Typ	Max	Unit
SCLK clock frequency	$t_{SCL}$	0	—	400	kHz
Bus free-time for stop condition and start condition	$t_{BUF}$	1.3	—	—	$\mu$ s
Hold time start condition	$t_{HDSTA}$	0.6	—	—	$\mu$ s
SCLK clock low-state hold time	$t_{LOW}$	1.3	—	—	$\mu$ s
SCLK clock high-state hold time	$t_{HIGH}$	0.6	—	—	$\mu$ s
Data hold time	$t_{HDDAT}$	0	—	—	$\mu$ s
Data setup time	$t_{SUDAT}$	100	—	—	ns
S-data, SCLK signal rise time	$t_r$	—	—	300	ns
S-data, SCLK signal fall time	$t_f$	—	—	300	ns
Stop condition setup time	$t_{SUSTO}$	0.6	—	—	$\mu$ s

##### (7) Mode setting channel bits table

D7	D6 to D4	D3	D2	D1	D0	Selection channel	EVR control function	Number of bits
Mode	Don't Care	0	0	0	0	0	Vertical sync. signal output position	3
		0	0	0	1	1	Horizontal sync. signal output position	5
		0	0	1	0	2	PWM duty	6
		0	0	1	1	3	Common pulse amplitude	7
		0	1	0	0	4	Y-gain	8
		0	1	0	1	5	Color gain	7
		0	1	1	0	6	Hue	7
		0	1	1	1	7	Black-limiter level	8
		1	0	0	0	8	Brightness	8
		1	0	0	1	9	Y-aperture gain	8
		1	0	1	0	10	R-ch. sub-brightness	8
		1	0	1	1	11	B-ch. sub-brightness	8
		1	1	0	0	12	White peak limiter	8
		1	1	0	1	13	Gamma-1 Knee level	8
		1	1	1	0	14	Gamma-2 Knee level	8
1	1	1	1	15	RGB contrast	7		

In case that the channels have 8 bits or less of data bits number, the data in the data block is used to set various modes. The content of each mode setting is same as three-wire control mode

## ■ Technical Data (continued)

### 2. Recommended Operating Conditions

Parameter	Symbol	Min	Typ	Max	Unit
Composite video input signal (Sync. chip - white)	$Y_{IN}$	0.9	1.0	1.1	V[p-p]
Y-input signal voltage (Pedestal - white)	$Y_{IN}$	0.6	0.7	0.8	V[p-p]
C-input signal voltage (Burst signal amplitude)	$C_{IN}$	200	300	400	mV[p-p]
MOS input signal low-level voltage	$V_{MOSL}$	0	—	0.8	V
MOS input signal high-level voltage	$V_{MOSH}$	4.2	—	*	V
Synchronous signal input (Pedestal - sync. chip)	$H_{Sync}$	0.2	0.3	0.4	V[p-p]
Serial data transfer frequency	$f_{SD}$	—	—	1.0	MHz
Analog RGB input signal (Pedestal - white)	$RGB_{IN}$	0.6	0.7	0.8	V[p-p]

Note) \*: Set it lower than  $V_{CC1}$  (Pin 1 voltage).

### 3. Power dissipation of package QFP064-P-1010

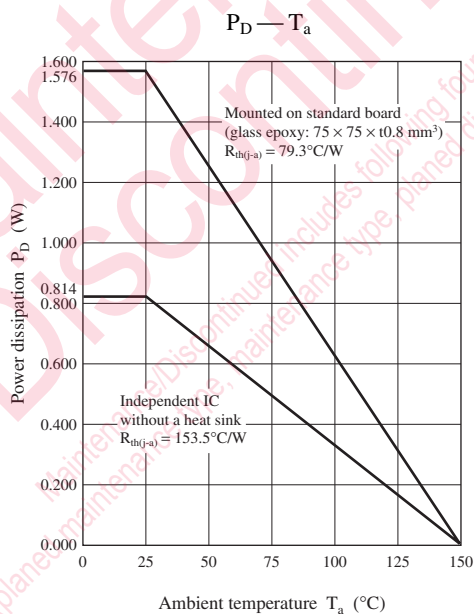

■ New Package Dimensions (Unit: mm)

- QFP064-P-1010A (Lead-free package)

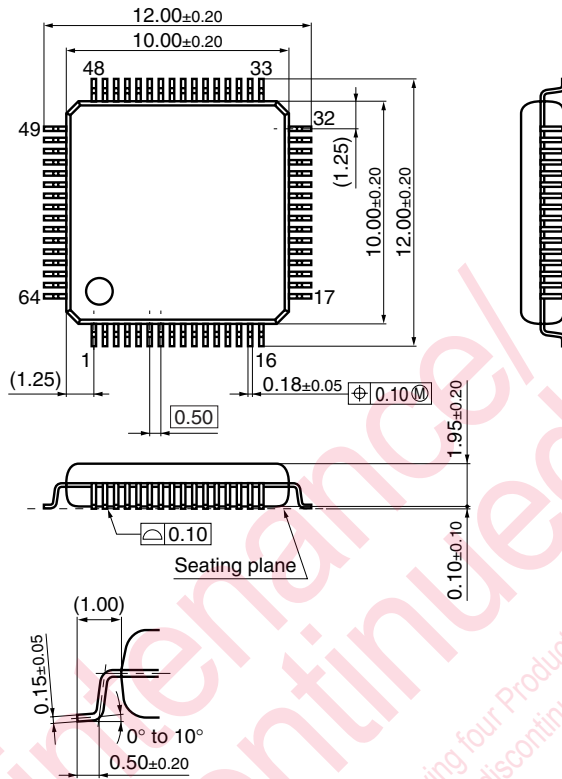

Maintenance/Discontinued

Maintenance/Discontinued includes following four Product lifecycle stage.  
(planned maintenance type, maintenance type, planned discontinued type, discontinued type)

## Request for your special attention and precautions in using the technical information and semiconductors described in this book

- (1) If any of the products or technical information described in this book is to be exported or provided to non-residents, the laws and regulations of the exporting country, especially, those with regard to security export control, must be observed.
- (2) The technical information described in this book is intended only to show the main characteristics and application circuit examples of the products, and no license is granted under any intellectual property right or other right owned by our company or any other company. Therefore, no responsibility is assumed by our company as to the infringement upon any such right owned by any other company which may arise as a result of the use of technical information described in this book.
- (3) The products described in this book are intended to be used for standard applications or general electronic equipment (such as office equipment, communications equipment, measuring instruments and household appliances).  
Consult our sales staff in advance for information on the following applications:
  - Special applications (such as for airplanes, aerospace, automobiles, traffic control equipment, combustion equipment, life support systems and safety devices) in which exceptional quality and reliability are required, or if the failure or malfunction of the products may directly jeopardize life or harm the human body.
  - Any applications other than the standard applications intended.
- (4) The products and product specifications described in this book are subject to change without notice for modification and/or improvement. At the final stage of your design, purchasing, or use of the products, therefore, ask for the most up-to-date Product Standards in advance to make sure that the latest specifications satisfy your requirements.
- (5) When designing your equipment, comply with the range of absolute maximum rating and the guaranteed operating conditions (operating power supply voltage and operating environment etc.). Especially, please be careful not to exceed the range of absolute maximum rating on the transient state, such as power-on, power-off and mode-switching. Otherwise, we will not be liable for any defect which may arise later in your equipment.
  - Even when the products are used within the guaranteed values, take into the consideration of incidence of break down and failure mode, possible to occur to semiconductor products. Measures on the systems such as redundant design, arresting the spread of fire or preventing glitch are recommended in order to prevent physical injury, fire, social damages, for example, by using the products.
- (6) Comply with the instructions for use in order to prevent breakdown and characteristics change due to external factors (ESD, EOS, thermal stress and mechanical stress) at the time of handling, mounting or at customer's process. When using products for which damp-proof packing is required, satisfy the conditions, such as shelf life and the elapsed time since first opening the packages.
- (7) This book may be not reprinted or reproduced whether wholly or partially, without the prior written permission of Matsushita Electric Industrial Co., Ltd.