



# SHOGYO PHONO JACK PHENOLIC BOARD CONNECTOR

UNIT: MM

STRAIGHT, RIGHT ANGLE ; CHASSIS SCREW, PRINTED CIRCUIT BOARD TYPE

## SX-019H

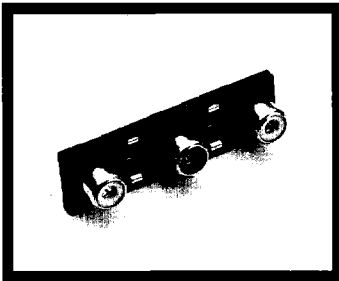

STRAIGHT CHASSIS SCREW JACK

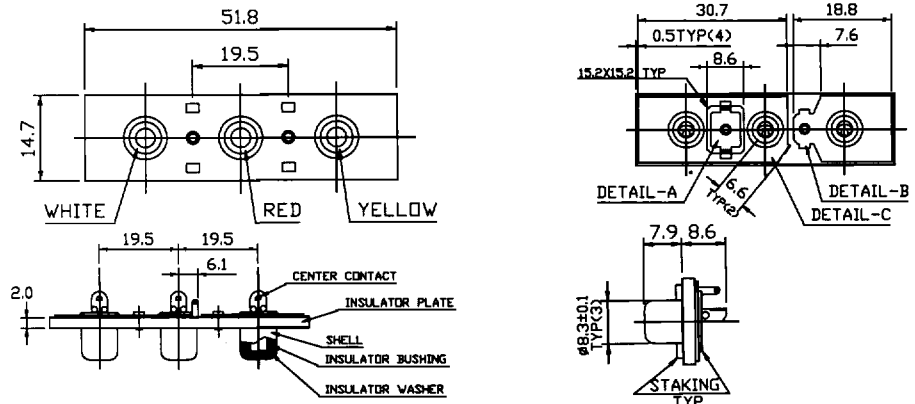

## SX-140A

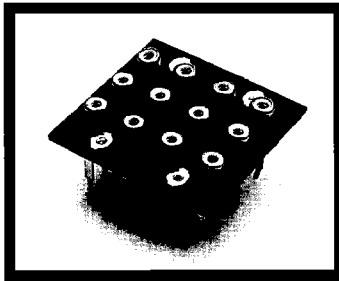

STRAIGHT PCB MOUNT JACK

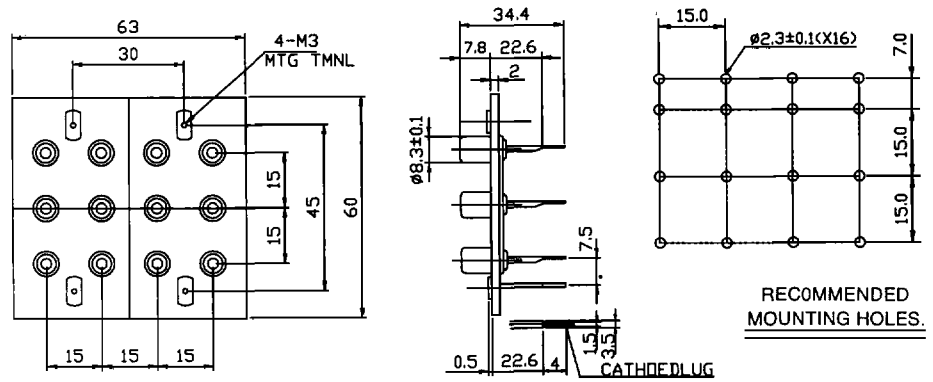

## SX-223

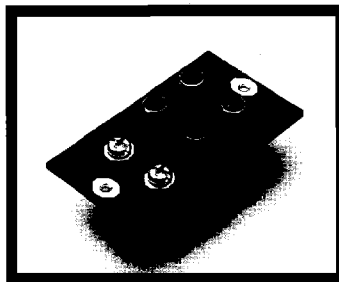

STRAIGHT SCREW PCB MOUNT JACK

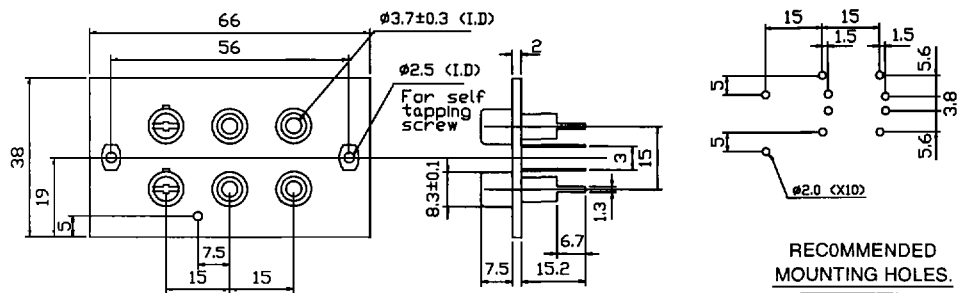

## SX-041D

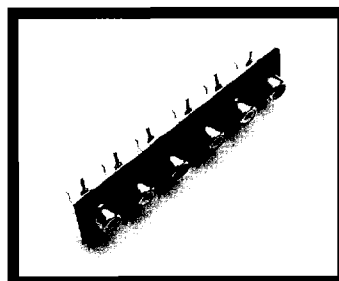

RIGHT ANGLE PCB MOUNT JACK

